



**KING COUNTY**

1200 King County Courthouse  
516 Third Avenue  
Seattle, WA 98104

**Signature Report**

**Motion 15694**

**Proposed No.** 2020-0278.1

**Sponsors** Lambert

1           A MOTION acknowledging receipt of a report on the  
2           management of biosolids, including a description and  
3           evaluation of alternative options for the use of biosolids  
4           prepared in accordance with the 2019-2020 Biennial  
5           Budget Ordinance, Ordinance 18835, Section 108, as  
6           amended by Ordinance 18930, Section 72, Proviso P3.

7           WHEREAS, the King County 2019-2020 Biennial Budget Ordinance, Ordinance  
8           18835, Section 108, as amended by Ordinance 18930, Section 72, Proviso P3, states that  
9           \$100,000 shall not be expended or encumbered until the executive transmits a report on  
10          the management of biosolids generated in the processing of wastewater at county  
11          facilities, and a motion that acknowledges receipt of the report and the motion is passed  
12          by the council, and

13          WHEREAS, the executive has transmitted to the council the requested report  
14          entitled Alternative Options for the Use of Biosolids along with a motion acknowledging  
15          the receipt thereof by June 1, 2020;

16          NOW, THEREFORE, BE IT MOVED by the Council of King County:

17          Receipt of the report addressing the management of biosolids, including a

Motion 15694

---

18 description and evaluation of alternative options for the use of biosolids, Attachment A to  
19 this motion, is hereby acknowledged.

20

Motion 15694 was introduced on 9/1/2020 and passed by the Metropolitan King County Council on 10/27/2020, by the following vote:

Yes: 9 - Ms. Balducci, Mr. Dembowski, Mr. Dunn, Ms. Kohl-Welles, Ms. Lambert, Mr. McDermott, Mr. Upthegrove, Mr. von Reichbauer and Mr. Zahilay

KING COUNTY COUNCIL  
KING COUNTY, WASHINGTON

DocuSigned by:  
*Claudia Balducci*  
7E1C273CE9994B6...

---

Claudia Balducci, Chair

ATTEST:

DocuSigned by:  
*Melani Pedroza*  
8DE1BB375AD3422...

---

Melani Pedroza, Clerk of the Council

**Attachments:** A. Alternative Options for the Use of Biosolids August 1, 2020

## Alternative Options for the Use of Biosolids

---

August 1, 2020



**King County**

## Contents

|   |    |
|---|----|
| Proviso Text.....                         | 3  |
| Executive Summary .....                   | 4  |
| Background.....                           | 7  |
| Report Requirements .....                 | 9  |
| A. Construction of a Local Facility ..... | 13 |
| B. Costs and Benefits.....                | 14 |
| C. Physical Footprint .....               | 18 |
| D. Storage Volume.....                    | 19 |
| E. Map of Biosolids Applications.....     | 20 |
| F. Financial Analysis .....               | 21 |
| Conclusion .....                          | 23 |
| Appendices .....                          | 23 |

## Tables

|   |    |
|---|----|
| Table 1: Total Costs and Scores .....   | 6  |
| Table 2: Types of Costs and Benefits .....                                    | 14 |
| Table 3: Summary of Escalated Capital Cost.....                               | 15 |
| Table 4: Summary of 2050 Annual Operations and Maintenance and Revenues ..... | 16 |
| Table 5: Summary of 2050 Annual Transportation Costs .....                    | 17 |
| Table 6: Physical Footprint (Land) Required .....                             | 19 |
| Table 7: Total Costs and Scores .....   | 22 |

## Figures

|  |    |
|--|----|
| Figure 1: Depiction of the Baseline: Class B, Existing Program.....      | 9  |
| Figure 2: Depiction of Alternative Option One: 100 Percent Class A ..... | 12 |
| Figure 3: Depiction of Alternative Option Two: Pyrolysis.....            | 13 |
| Figure 4: Annual Carbon Credits and Debits.....                          | 18 |
| Figure 5: Mapped Locations of Current Land Application of Biosolids..... | 21 |



## Proviso Text

### [Ordinance 18930, Section 72, Proviso P3<sup>1</sup>](#)

P3 PROVIDED FURTHER THAT:

Of this appropriation, \$100,000 shall not be expended or encumbered until the executive transmits a report on the management of biosolids generated in the processing of wastewater at county facilities and a motion that acknowledges receipt of the report, and a motion acknowledging receipt is passed by the council. The motion should reference the subject matter, the proviso's ordinance, ordinance section, and proviso number in both the title and body of the motion.

The primary existing biosolids processing strategy utilized by the county emphasizes the land application of biosolids generated by the wastewater treatment process at county facilities ("biosolids") in forest and farm environments. The report shall describe and evaluate alternative options for the use of those biosolids. The report should also address alternative biosolids management approaches that may lead to an expansion or diversification of the markets for those biosolids.

The report shall include, but not be limited to:

- A. As an alternative option to be evaluated, the construction of a local biosolids facility that could generate by-products to include gas, electricity, Class A soil enhancer/amendment or for other productive uses;
- B. To compare the costs and benefits of the alternative options to the existing strategy a financial analysis comparing the alternative options to the existing strategy, including the transportation costs of the existing strategy;
- C. The size of the physical footprint needed for a biosolids facility sited locally, at which those biosolids could be further refined into marketable by-products, including gas, electricity and Class A soil enhancer or amendment;
- D. The volume of storage capacity required to store biosolids under the existing biosolids strategy and projected future storage capacity requirements. To the extent that under the existing biosolids strategy involves storage, the study shall also describe: (1) the volume of the storage; and (2) the proportion of total storage capacity that is being reached, described as peak storage levels over the past year;
- E. The mapped locations of current land application of biosolids; and
- F. A financial analysis of a strategy to transition all or a portion of the current production of biosolids to Class A biosolids, including discussion of the financial viability of the transition.

The executive should file the report and a motion required by this proviso by June 1, 2020<sup>2</sup>, in the form of a paper original and an electronic copy with the clerk of the council, who shall retain the original and provide an electronic copy to all councilmembers, the council chief of staff and the lead staff for the regional water quality committee and the committee of the whole, or their successors.

---

<sup>1</sup> [Link to Ordinance 18930](#)

<sup>2</sup> Due COVID 19, the King County Council passed Motion 15620, which extends due dates on reports by 60 days.

## Executive Summary

### Background

This report examines alternative options for the King County Loop Biosolids Program<sup>3</sup> in accordance with [Ordinance 18930, Section 72, Proviso P3](#). The information in this report is based on a technical study completed in 2020 by the consultant [Brown and Caldwell](#)<sup>4</sup>, which is attached as Appendix A, as well as an extensive number of other relevant King County studies on Class A options. Analyses provided in this report are informed by current operational and capital costs, King County strategic objectives, and environmental and wastewater treatment process information for King County's three regional treatment plants: West Point, South Plant, and Brightwater.

The mission of the Wastewater Treatment Division (WTD) of the Department of Natural Resources and Parks (DNRP) is to protect public health and enhance the environment by collecting and treating wastewater while recycling valuable resources for the Puget Sound region. The [Biosolids Program](#), housed within the WTD's Resource Recovery section, manages the distribution and use of, the biosolids product created by recycling King County's wastewater, which is called [Loop](#).

Regulations established two types of biosolids: Class A and Class B. Class A biosolids have virtually no detectable pathogens and can be used by the public for activities such as landscaping and gardening. Class B biosolids are treated, but do have detectable levels of pathogens and require a permit for use for in activities such as agriculture and forestry.

Since 1984, King County has beneficially used 100 percent of its Loop biosolids, a Class B product, as a fertilizer replacement and soil amendment, primarily in forestry and agriculture. Loop biosolids return valuable carbon and nutrients back to the soil and help King County fight climate change. However, with fluctuations in forestry application and the May 2020 business closure of the County's Biosolids Program's compost partner, GroCo Inc., the market resiliency of the Biosolids Program has decreased. In recent years, over 75-80 percent of Loop biosolids went to agricultural use in eastern Washington. GroCo Inc. used one percent of King County's Loop biosolids to create its Class A compost product locally. While one percent is small, the Class A GroCo Inc. compost product made with Loop was the only publicly accessible product for King County residents and gardeners.

The current DNRP Biosolids Program, which produces a Class B product, complies with regulations and policies on federal, state, and County levels, under the [Clean Water Act Part 503](#), [Washington Administrative Code Chapter 173-308](#), and [King County Code 28.86.090](#) Biosolids Policies, respectively. King County could transition from producing a 100 percent Class B product at its treatment plants to the production of Class A biosolids in the future through either treatment plant upgrades or a construction of a composting facility.

---

<sup>3</sup> The term "biosolids" refers to the solid organic matter recovered from the wastewater treatment process that can be used as a soil amendment or enhancement. Loop is the brand name of the biosolids produced at King County's three wastewater treatment plants.

<sup>4</sup> The report from Brown and Caldwell is attached as Appendix A

## Report Requirements

DNRP contracted with Brown and Caldwell to research Class A alternative options for this proviso response. The resulting report is attached as Appendix A. Each option analyzed assumes the use of 100 percent of King County’s biosolids to enable comparison of costs and benefits with the existing Class B Biosolids Program. The report details the estimated cost and benefits of maintaining the existing Class B program as a baseline and two alternative options projected out to the year 2050. The options are:

- *Baseline: Class B* - Continuation of the existing Class B Biosolids Program, including necessary upgrades to address future treatment capacity needs and maintain the treatment system that produces biosolids.
- *Alternative Option One: Class A* – This option includes Class A digestion at the treatment plants paired with a soil blending facility<sup>5</sup>, as well as composting<sup>6</sup> Class B biosolids into a Class A compost, thereby transitioning to a 100 percent Class A biosolids program by leveraging different technologies.
- *Alternative Option Two: Pyrolysis* – This option would involve the creation of a public-private partnership to dry and pyrolyze<sup>7</sup> Class B biosolids into biochar<sup>8</sup> at a new offsite pyrolysis facility. It should be noted that biochar may only be considered Class A biosolids under the state biosolids rule [WAC 173-308](#) on a case by case basis. However, a pyrolysis option was included to show the costs and benefits of an emerging technology and a different programmatic direction.

### *Construction of a Local Facility*

The *Baseline: Class B* option assumes that all changes would take place on the sites of the regional treatment plants. Both *Alternative Option One: 100 Percent Class A* and *Alternative Option Two: Pyrolysis* would require the construction of offsite local facilities, outside of the treatment plant footprints. In *Alternative Option One: 100 Percent Class A*, it would be necessary to site, permit, and construct a soil blending and composting facility. To accomplish *Alternative Option Two: Pyrolysis*, King County would need to site, permit, and construct a drying and pyrolysis facility.

### *Costs and Benefits*

The alternative options were compared on a variety of factors including capital and operating costs, transportation costs, environmental impacts, equity and social justice factors, technical and

---

<sup>5</sup> Digestion refers to the process in which microorganisms break down biodegradable material, like solids in wastewater. When it is done in the absence of oxygen it is called anaerobic digestion. Class A digestion creates biosolids that meet United States Environmental Protection Agency standards by operating at a temperature of 122°F to 140°F, called thermophilic temperatures, in order to reduce pathogens to the level required for Class A biosolids. In order to make a marketable product, Class A digestion can be combined with soil blending, which involves mixing Class A biosolids with sand and woody materials, such as bark and sawdust, to create blends that can be used as potting mix or topsoil.

<sup>6</sup> Composting is an aerobic biological process that uses microorganisms in the presence of air to decompose organic material and to produce heat to reduce pathogens to Class A requirements. Composting biosolids involves mixing Class B biosolids with woody materials and composting them.

<sup>7</sup> Pyrolysis is a decomposition process that occurs at temperatures in excess of 572°F in the absence of air. The process produces a charcoal-like soil amendment called biochar.

<sup>8</sup> Biochar is a charcoal-like soil amendment.

implementation difficulty, and synergy with King County objectives and WTD priorities. Table 1 shows a summary of the results.

| Table 1. Total Costs and Scores                                 |                   |   |                                   |
|---|-------------------|---|-----------------------------------|
|   | Baseline: Class B | Alternative Option One: 100 Percent Class A | Alternative Option Two: Pyrolysis |
| Escalated Capital Costs   | \$335,000,000     | \$590,000,000                               | \$1,115,000,000                   |
| 2050 Operating & Maintenance Costs                              | \$40,500,000      | \$49,000,000                                | \$39,000,000                      |
| 2050 Annual Transportation Costs                                | \$6,000,000       | \$4,000,000                                 | \$1,500,000                       |
| 2050 Annual Revenue   | \$11,100,000      | \$19,500,000                                | \$10,500,000                      |
| 2050 Annual Net Operating & Maintenance Costs and Minus Revenue | \$29,400,000      | \$29,500,000                                | \$28,500,000                      |
| Triple Bottom Line Score <sup>9</sup>                           | High              | Very High                                   | Medium                            |

Table 1: Total Costs and Scores

### Physical Footprint

All physical site requirements used in this analysis are approximate. Actual site requirements would be refined further based on selected technology and actual site constraints, during WTD's capital project delivery process. The physical footprint required is 30-40 acres for an offsite soil blending and compost facility in *Alternative Option One: 100 Percent Class A* and 12 acres for an offsite pyrolysis facility in *Alternative Option Two: Pyrolysis*. The *Baseline Class B* does not require an offsite facility.

### Storage Requirements and Mapped Locations of Current Land Application

The current biosolids program is designed to transfer biosolids from the treatment plants directly to land application sites for use as soon as the biosolids are fully treated. Biosolids are temporarily stored in emergency situations when it is not possible to haul biosolids and/or land apply in either eastern or western Washington due to inclement weather and mountain pass closure. WTD contracts with the City of Everett Wastewater Treatment Plant to store biosolids at the facility during these weather events and typically uses less than half of the available space during peak storage times. A map of the locations where biosolids are land applied for agriculture or forestry uses is included.

### Financial Analysis

Analyses find that all identified options are costly, ranging from \$335 million to \$1.1 billion in capital investments, and face a number of technical and physical challenges, such as footprint constraints, permitting challenges, and the implementation of new technologies. See Section B in this report for details. Development of a Class A program is encouraged by state and federal statute, but would require changes in the King County Code to align the code with state law, thus enabling King County to produce Class A or Class B biosolids.

<sup>9</sup> For more information on Triple Bottom Line, see Appendix B.

## Conclusion

This report finds that opportunities exist for King County to explore transition to Class A biosolids as a long-term, phased approach over many decades. Transitioning to Class A could be incorporated into planning efforts for improvements to the County's regional treatment plants to address capacity needs, asset management (i.e., repair, refurbishment or replacement of aging equipment), and other physical plant needs and County goals.

Any development of a Class A program would require changes to biosolids policies in King County Code, since the King County Code currently prohibits the production and sale of anything other than Class B Biosolids.<sup>10</sup> WTD is currently in the process of designing a small-scale temporary compost pilot project at South Treatment Plant to test composting and explore marketability of a County-owned Class A compost. The current cost estimate for the pilot project is \$3.4 million with project completion anticipated in 2022/2023. This work in developing the pilot project to produce Class A compost at South Treatment Plant could help inform future planning efforts.

## Background

**Department Overview:** The Department of Natural Resources and Parks (DNRP) works in support of sustainable and livable communities and a clean and healthy natural environment. Its mission is to foster environmental stewardship and strengthen communities by providing regional parks, protecting the region's water, air, land, and natural habitats, and reducing, safely disposing of, and creating resources from wastewater and solid waste.

The Wastewater Treatment Division (WTD) of DNRP protects public health and enhances the environment by collecting and treating wastewater while recycling valuable resources for the Puget Sound region. The King County Biosolids Program is housed within the Resource Recovery Section of WTD.

The Resource Recovery Section manages the administration and delivery of products and programs from renewable resources<sup>11</sup> captured from the wastewater treatment process. The Resource Recovery Section is comprised of a strategic support team and five programs: Sustainability, Technology Assessment and Innovation, Energy, Recycled Water, and Biosolids. The Biosolids Program manages the distribution and use of Loop, a branded biosolids product created by recycling the County's wastewater. Loop is a natural soil builder and endlessly renewable resource that has been returning carbon and nutrients to the land for almost 50 years.

**Key Historical Conditions:** Since its inception, the King County Biosolids Program has taken a market-based approach to biosolids management, focusing on creating high quality marketable products, and developing strong customer relationships. The Biosolids Program has successfully produced and distributed its biosolids for almost 50 years with full regulatory compliance and beneficial use.

---

<sup>10</sup> [King County Code 28.86.090 Biosolids policies \(BP\)](#).

<sup>11</sup> A renewable resource is a [natural resource](#) which will replenish to replace the portion [depleted](#) by usage and consumption. Biogas, biosolids, and recycled water are three byproducts of the wastewater system that are considered renewable resources.

The Biosolids Program, in conjunction with University of Washington scientists, began researching and developing a program in 1972 for biosolids to be used on forestlands and land that needed to be reclaimed from other uses such as mining. In 1978, the Biosolids Program entered a long-standing partnership with GroCo, Inc. to compost a portion of its biosolids into a retail garden product. After nearly two decades of operations, the Biosolids Program added two agricultural projects in Yakima and Douglas Counties.

In 1993, federal biosolids regulations were added to [The Clean Water Act of 1972 \(CWA\)](#) and [40 CFR Part 503](#) of the CWA established standards, which consist of general requirements, pollutant limits, management practices, and operational standards, for the final use of biosolids generated during the treatment of domestic sewage. Washington State followed suit, developing the [biosolids rule, or chapter 173-308](#) in the [Washington Administrative Code \(WAC\)](#) in 1998. It is important to note that the biosolids rule established the requirement for beneficial use of biosolids that “encourages the maximum beneficial use of biosolids” and “recognizes biosolids as a valuable commodity.” The biosolids rule incorporates all the legal requirements in the federal rule, with additional site-specific plans for land application and public notice requirements. Regulations established two types of biosolids: Class A and Class B. Class A biosolids have virtually no detectable pathogens and can be used without a permit. King County produces Class B biosolids, which are treated, but do have detectable levels of pathogens and require a permit for use.

In addition to developing a successful Class B program, the Biosolids Program examined opportunities for Class A options many times over the past several decades. Class A options have not been undertaken due to prioritizing other operational and infrastructure needs.

**Key Current Conditions:** King County currently produces approximately 130,000 wet tons of biosolids each year at three regional treatment plants, which is equivalent to filling a stadium 70 feet high or filling 8,000 Metro buses. Each of King County’s treatment plants is slightly different, but all use a technology called anaerobic digestion, which is a large heated tank where microorganisms break down the solids, similar to how a human stomach digests food. King County uses 100 percent of the Class B Loop biosolids produced at the County’s wastewater treatment plants in a beneficial way on land, primarily as a fertilizer replacement in forestry and agriculture as shown below in Figure 1. However, with fluctuations in forestry use over the past decade, the program became more reliant on agricultural uses, reducing options for the Biosolids Program if biosolids use in agriculture declines.

Farmers in Douglas and Yakima Counties currently use most (80-85 percent) of King County’s biosolids. In May 2020, the Biosolids Program’s compost partner GroCo Inc., which used one percent of King County’s Loop product as an ingredient to produce a retail garden product called GroCo compost, closed its business. Composting involves mixing biosolids with woody material, such as sawdust, yard clippings, or wood chips, and then microorganisms break down the material into a garden product called compost. While one percent is a small amount and King County did not own the final product, GroCo compost made with Loop was the only publicly accessible product for use by King County residents and gardeners. Other composters in the region are already nearing capacity, meaning they cannot accept more biosolids for use in compost, and have not shown interest in partnering with DNRP.

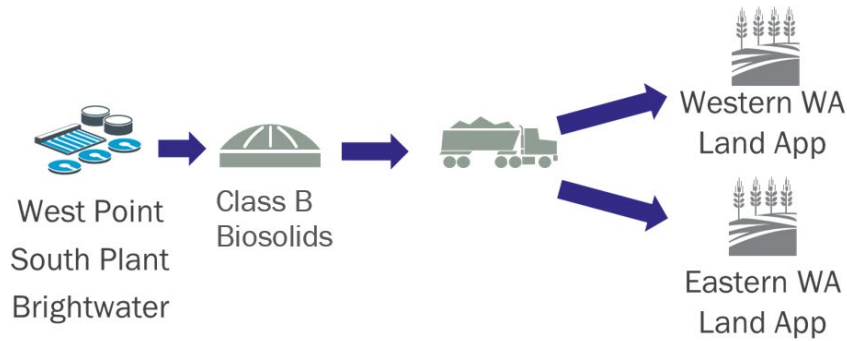

Figure 1: Depiction of the Baseline: Class B, Existing Program

King County’s Biosolids Program also plays a key role in accomplishing the goals of the [Clean Water Healthy Habitat](#) initiative and the [Strategic Climate Action Plan](#), primarily through carbon sequestration from land application.<sup>12</sup> In 2019, Loop biosolids use provided 20 percent of the carbon offsets for DNRP’s carbon footprint.<sup>13</sup> Energy capture and reuse from the anaerobic digesters<sup>14</sup> at King County’s wastewater treatment plants allow WTD to operate in a more energy efficient manner. In addition, DNRP’s partnership with GroCo Inc. for Class A biosolids allowed DNRP to participate in King County’s [Equity and Social Justice Initiatives](#) by supporting community gardens in underserved areas with compost donations and by maintaining a robust and far-reaching outreach and education program.

**Report Methodology:** DNRP contracted the consulting firm of Brown and Caldwell to assist WTD with research for this report. DNRP staff from operations, finance, community services, resource recovery, engineering, and planning participated in the development of this report. Building on the foundation of previous Class A evaluations, the consultants referred to past reports and conducted additional research. Environmental and treatment process information was modeled to compare differences between options. DNRP staff and the consultants participated in a workshop to review and adjust the model, and assumptions, and reach consensus on the Triple Bottom Line<sup>15</sup> analysis provided in Appendix B to this document. The consultant technical memorandum/report is attached as Appendix A.

## Report Requirements

Taking into account federal, state, and local biosolids regulations and policies, current and future wastewater treatment plant capacity, and the strategic environmental and social objectives of King County, the following report details potential Class A options for the County’s Biosolids Program. The report requires the following:

<sup>12</sup> Carbon Sequestration refers to the process of removing carbon dioxide from the atmosphere.

<sup>13</sup> Carbon Offsets refer to actions take to compensate for carbon dioxide emissions. Offsets can be traded as part of environmental programs.

<sup>14</sup> Some wastewater treatment plants use anaerobic digesters to provide an oxygen-free environment for microorganisms to break down organic matter in wastewater. The anaerobic digestion process produces wastewater digester gas, a methane-rich byproduct that can be used as an energy source.

<sup>15</sup> The Triple Bottom Line is an analysis method to account for environmental, economic, and social factors, and is commonly used in planning or feasibility studies to evaluate King County alternatives, options, and projects.

## Alternative Options for the Use of Biosolids



- A. As an alternative option to be evaluated, the construction of a local biosolids facility that could generate by-products to include gas, electricity, Class A soil enhancer/amendment or for other productive uses;*
- B. To compare the costs and benefits of the alternative options to the existing strategy a financial analysis comparing the alternative options to the existing strategy, including the transportation costs of the existing strategy;*
- C. The size of the physical footprint needed for a biosolids facility sited locally, at which those biosolids could be further refined into marketable by-products, including gas, electricity and Class A soil enhancer or amendment;*
- D. The volume of storage capacity required to store biosolids under the existing biosolids strategy and projected future storage capacity requirements. To the extent that under the existing biosolids strategy involves storage, the study shall also describe: (1) the volume of the storage; and (2) the proportion of total storage capacity that is being reached, described as peak storage levels over the past year;*
- E. Mapped Locations of Current Land Application of Biosolids; and*
- F. A financial analysis of a strategy to transition all or a portion of the current production of biosolids to Class A biosolids, including discussion of the financial viability of the transition.*

## **Overview**

In order to develop alternative options to the current Class B program, various biosolids processing technologies were explored in detail and assessed on several criteria. A detailed explanation of criteria and assessment process can be found in Appendix A.<sup>16</sup> After assessment, favorable technologies were developed into alternative options and compared to the baseline Class B program, all projected out to the year 2050. The options compared in the report are as follows:

### *Baseline: Class B Program*

This option consists of continuing the 100 percent Class B biosolids program at King County's three regional treatment plants, focusing on land application in western Washington forestry and eastern Washington agriculture.

As the region's population continues to grow, King County must maintain sufficient solids treatment capacity at its regional treatment plants.<sup>17</sup> King County currently produces approximately 130,000 wet tons of biosolids each year, and each treatment plant has unique operating processes and constraints. Even though this option continues the existing program, using the existing technology, investments will still be needed to maintain the equipment (i.e. digesters) that produce Class B biosolids to handle increasing solids treatment capacity needs through 2050. Therefore, investments are assumed in this option just to continue the existing Class B biosolids program while meeting solids treatment capacity needs through 2050.

### *Alternative Option One: 100 Percent Class A*

<sup>16</sup> See Table 1 on page 4 of Technical Memorandum in Appendix A.

<sup>17</sup> The assumed projects are high-level concepts developed to support this study. Capital projects to expand solids treatment capacity have not yet been determined through WTD planning or capital project delivery processes.



This option includes Class A digestion at the treatment plants paired with a soil blending facility<sup>18</sup>, as well as composting<sup>19</sup> Class B biosolids into a Class A compost, thereby transitioning to a 100 percent Class A biosolids program by leveraging different technologies. Combining these two technologies is necessary due to the large volume of biosolids produced by King County; it is not feasible to compost all of King County's biosolids<sup>20</sup>, but including composting provides valuable product and market diversity that could reduce the cost of transitioning to a 100 percent Class A program through revenue from product sales. Since this option is a combination of different technologies and facilities, informed by the unique constraints of each treatment plant, it also allows the flexibility of potentially phasing investments over time.

This option, shown in Figure 2, includes the upgrade of digester equipment at two regional treatment plants to produce Class A biosolids and the construction of an offsite soil blending and composting facility. The Class A biosolids produced at one of these treatment plants would be transported to the offsite compost and soil blending facility to create a marketable soil blend for retail sale to the public, or used directly by local commercial customers. The Class A biosolids produced at the other treatment plant would be delivered directly to agriculture and forestry land application sites in western and eastern Washington. The Class B biosolids produced at the third regional treatment plant would be transported to the composting and soil blending facility to be composted into a Class A garden product (compost) for retail sale.

Notably, the option outlined below and the technology selected for each treatment plant is just one example of how a combination of technologies and strategies could be deployed to achieve a Class A biosolids option. It should also be noted that this option would require changes to biosolids policies in King County Code to allow the production and sale of Class A biosolids.<sup>21</sup>

---

<sup>18</sup> Digestion refers to the process in which microorganisms break down biodegradable material, like solids in wastewater. When it is done in the absence of oxygen it is called anaerobic digestion. Class A digestion creates biosolids that meet United States Environmental Protection Agency standards by operating at a temperature of 122°F to 140°F, called thermophilic temperatures, in order to reduce pathogens to the level required for Class A biosolids. In order to make a marketable product, Class A digestion can be combined with soil blending, which involves mixing Class A biosolids with sand and woody materials, such as bark and sawdust, to create blends that can be used as potting mix or topsoil.

<sup>19</sup> Composting is an aerobic biological process that uses microorganisms in the presence of air to decompose organic material and to produce heat to reduce pathogens to Class A requirements. Composting biosolids involves mixing Class B biosolids with woody materials and composting them.

<sup>20</sup> A compost market assessment showed that there is market opportunity for King County biosolids compost representing approximately 20 percent of the total biosolids production.

<sup>21</sup> [King County Code 28.86.090 Biosolids policies \(BP\)](#).

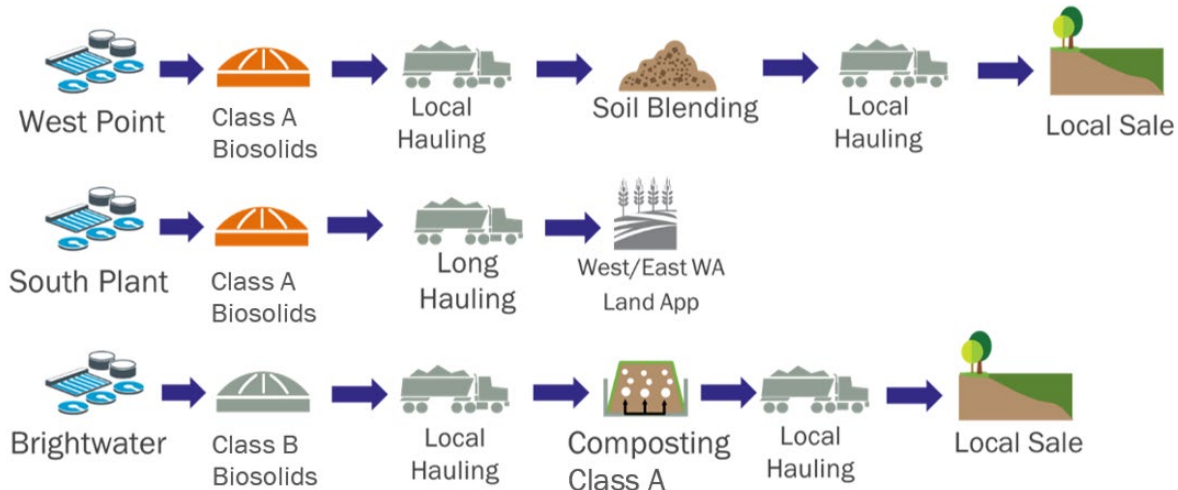

Figure 2: Depiction of Alternative Option One: 100 Percent Class A

#### Alternative Option Two: Pyrolysis

Although pyrolysis<sup>22</sup> technology did not meet all the original technology evaluation criteria<sup>23</sup>, a pyrolysis alternative option is included to demonstrate the benefits and tradeoffs of an emerging technology and a different programmatic direction. This alternative option, illustrated in Figure 3, would produce a potential Class A product called biochar. Biochar is a charcoal-like material that can be used as a soil amendment for improved soil health, though it does not provide much fertilization for plants. It has other potential uses as well, such as water filtration. In this option, all three treatment plants would continue to produce Class B biosolids while making changes required to address capacity needs through 2050.<sup>24</sup> One hundred percent of those biosolids would be hauled to a new offsite facility to be dried, compressed, and heated at a very high temperature to produce biochar.

<sup>22</sup> Pyrolysis is a decomposition process that occurs at temperatures in excess of 572°F in the absence of air. The process produces a charcoal-like soil amendment called biochar.

<sup>23</sup> An offsite pyrolysis facility did not pass the screening because pyrolysis did not meet the federal definition for established technologies, did not produce more gas to increase renewable energy production, and may increase greenhouse gas emissions. In addition, pyrolysis is not an approved Class A treatment process under the state biosolids rule ([WAC 173-308](#)), meaning it can only be considered Class A on a case by case basis. Only four biosolids pyrolysis facilities are operational in the United States with the largest facility, located in Redwood City, California, processing only 7,000 wet tons per year (compared to King County's 130,000 wet tons).

<sup>24</sup> The assumed capital projects are high-level concepts that were developed to support this study. Capital projects to expand digestion capacity have not yet been determined through WTD planning or capital project delivery processes.

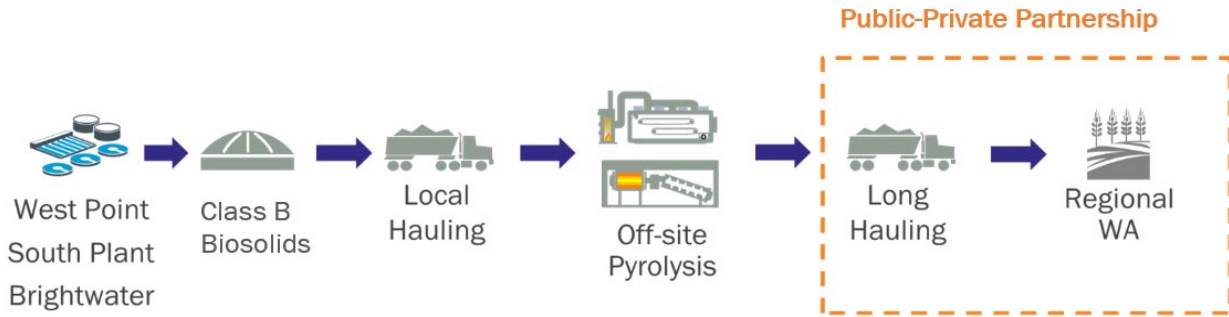

Figure 3: Depiction of Alternative Option Two: Pyrolysis

Other utilities, such as [Silicon Valley Clean Water](#), have used a public-private partnership for this type of option and this option assumes that King County would own and operate the pyrolysis facility and a private partner would transport and sell the biochar product. Contractual arrangements can vary, but the most common pyrolysis contractual arrangements are for the private partner to own and operate the pyrolysis facility, and distribute and sell the biochar product. King County adjusted this to retain control of the pyrolysis facility to ensure quality control and regulatory compliance, and to reflect King County's standard contractual arrangements. Given the emergent nature of the biochar market, King County does not have the staff or infrastructure to handle the sale of the product. This is in contrast to the compost market, in which King County has decades of experience.

This option also includes biosolids drying technology. In order for pyrolysis to be effective, biosolids must first be dried to 60 to 90 percent solids. King County's biosolids are approximately 25 percent solids and 75 percent water. The advantages of pyrolysis include volume reduction and generation of a marketable end-product. Research also demonstrates the reduction of some contaminants of emerging concern, such as triclosan and nonylphenol.<sup>25</sup> It should also be noted that this option would require significant changes to biosolids policies in the King County Code.<sup>26</sup>

### A. Construction of a Local Facility

Both *Alternative Option One: 100 Percent Class A* and *Alternative Option Two: Pyrolysis* would require the construction of offsite local facilities, outside of the treatment plant footprints. The *Baseline: Class B* option assumes that all changes would take place on the sites of the regional treatment plants.

For *Alternative Option One: 100 Percent Class A*, it would be necessary to site, permit, and construct a soil blending and composting facility. At this facility, Class A biosolids from one of the regional treatment plants would be mixed with woody materials and/or sand to create soil blends for retail sale. Class A biosolids do not require additional treatment and could be used by the general public straight from the treatment plant, but soil blending allows for a higher quality, lower odor product, and more variety of products for different markets. Class B biosolids from the third regional treatment plant would be transported to this same facility to be mixed with woody material and composted to create a Class A

<sup>25</sup> Lee et al., 2018; Paz-Ferreiro et al., 2018; Ross et al., 2016

<sup>26</sup> [King County Code 28.86.090 Biosolids policies \(BP\)](#).

product for retail sale. Class A biosolids from the second regional treatment plant would go straight from the treatment plant to land application in eastern and western Washington.

To accomplish *Alternative Option Two: Pyrolysis*, King County would need to site, permit, and construct a drying and pyrolysis facility. Class B biosolids from the three regional treatment plants would be transported to this site. The Class B biosolids would be dried to 60-90 percent solids using drying equipment and then run through pyrolysis equipment to create biochar, which could be sold as a soil amendment or water filtration medium.

More information about the physical footprint of these facilities is outlined in section C of this report.

## B. Costs and Benefits

Costs and benefits of the alternative options were compared to a continuation of the existing program. The types of costs and benefits included are defined in Table 2. In order to capture the complexity and compare these costs and benefits, several aspects were considered, including non-monetary costs and benefits. Non-monetary costs and benefits were provided through a greenhouse gas inventory<sup>27</sup> and a triple bottom line analysis<sup>28</sup>. The Office of Performance, Strategy, and Budget has reviewed the fiscal information contained in this report.

| Table 2. Types of Costs and Benefits |   |                       |   |
|--------------------------------------|---|-----------------------|---|
| Description                          |   | Benefits              |   |
| Capital Costs                        | Fixed expenses for the purchase of land, buildings, construction, and equipment or upgrade of physical systems or equipment. Includes design, permitting, and site acquisition.   | Revenue               | Money received by King County from customers as payment for products and any associated services.                             |
| Operating Costs                      | Day to day costs to operate facilities and equipment, and to implement and run programs. Includes staff and labor, maintenance and parts replacement, material use, energy and water consumption, and end-use including transportation. | Non-monetary benefits | Greenhouse gas offsets, carbon sequestration and qualitative environmental, social and economic benefits such as cleaner air. |
| Non-monetary Costs                   | Greenhouse gas emissions and qualitative environmental, social and economic costs, such as odor or increased traffic.   |                       |   |

Table 2: Types of Costs and Benefits

<sup>27</sup> A greenhouse gas inventory is an accounting of greenhouse gas emissions and offsets. The greenhouse gas emission scopes and factors were based on the guidelines published by The Climate Registry (TCR) and Intergovernmental Panel on Climate Change (IPCC) and updated with recent publications.

<sup>28</sup> The triple bottom line is an analysis method to account for environmental, economic, and social factors, and is commonly used in planning or feasibility studies to evaluate King County alternatives, options, and projects.

## Capital Costs

All options involve large capital investments to construct new systems as well as increased operational costs to and implement new processes by 2050. There are significant capital costs for three options.

Estimated total capital costs<sup>29</sup> for each option are shown in Table 3. For this study, capital costs were escalated to the construction midpoint of 2028 using an escalation rate of three percent to account for inflation and to estimate project capital costs and schedules. The totals represent implementation at all three treatment plants. Technical details detailed costs for each option can be found in Appendix A.

| Options                                     | Estimated Total Project Capital Cost<br>(Escalated to midpoint of construction in 2028) |
|---|---|
| Baseline: Class B                           | \$335   |
| Alternative Option One: 100 Percent Class A | \$590   |
| Alternative Option Two: Pyrolysis           | \$1,115   |

Table 3: Summary of Escalated Capital Cost

Even though the continuation of the current program, *Baseline: Class B*, does not require construction of a new offsite facility, it would require significant capital upgrades to the treatment plant digesters, (replacing or adding digesters and supporting systems), such as those that capture biogas for renewable energy or treat odor. These investments are needed to provide additional capacity to process more solids as the region's population increases. Capital costs for this option are estimated to be \$335,000,000.

*Alternative Option One: 100 Percent Class A* requires the construction of an offsite composting and soil blending facility. This would entail land acquisition and building a facility that includes components such as an aeration system to blow air through the compost, odor control systems, and ancillary equipment such as front end loaders and mixers. This option requires changes to two treatment plants to add Class A digesters, as well as maintaining and upgrading existing Class B equipment at one treatment plant to address solids capacity needs. Capital costs for this option are estimated to be \$590,000,000.

*Alternative Option Two: Pyrolysis* has the same requirements as the *Baseline: Class B* option at the treatment plants, which maintains and upgrades Class B digesters at the three treatment plants to serve an increased regional population. This option also requires land acquisition and the construction of an offsite drying and pyrolyzing facility, which includes components such as buildings, a dryer, boilers, pyrolysis units, and odor control. This option requires the most engineering and equipment. Capital costs for this option are estimated to be over one billion dollars.

<sup>29</sup> Estimated capital costs of either offsite facilities or upgraded digestion presented in this report are pre-planning level estimates based on the Association for the Advancement of Cost Engineering (AACE International) standards. WTD's capital cost estimating guidelines require capital costs to be estimated at key phases to further refine cost estimates as the project moves through the capital delivery process. Planning level estimates are conceptual and therefore have low levels of accuracy (+/-100 percent). These were input into King County's cost models.

### Operation and Maintenance Costs and Revenues

In addition to the capital costs, all options have operation and maintenance costs and revenues. Operation and maintenance costs are the day to day costs to run the facility or program and include biosolids processing at the treatment plants and Biosolids Program operations such as research, compliance, monitoring, transportation, and application to customer sites in agriculture and forestry. Revenues from biosolids product sales, as well as electricity and renewable natural gas (produced by the digesters), are also included. Revenues are highly variable based on the market. The assumptions are variable due to the uncertainty of a 50-year projection. Market assumptions were made with knowledge of 2020 conditions only and were conservative. There is opportunity to optimize production and local sale of Class A products to decrease cost and increase revenue.

Total annual operations and maintenance costs were roughly the same for all three – the baseline and two options. Annual operations costs are presented for the year 2050, which assumes fully executed capital projects, full maturity of product markets and revenue, and a linear projected increase of biosolids production from 2018-2050. A summary of annual operations and maintenance costs and revenue is provided in Table 4, which includes annual transportation costs as part of operations and maintenance. Transportation costs alone for each option are provided in Table 5.

| Table 4. Summary of 2050 Annual Operations and Maintenance (O&M) and Revenues<br>(in \$ millions) |         |           |         |
|---|---------|-----------|---------|
| Options   | O&M     | Revenues  | Total   |
| Baseline: Class B   | \$40.50 | (\$11.10) | \$29.40 |
| Alternative Option One:<br>100 Percent Class A  | \$49.00 | (\$19.50) | \$29.50 |
| Alternative Option Two: Pyrolysis   | \$39.00 | (\$10.50) | \$28.50 |

Table 4: Summary of 2050 Annual Operations and Maintenance and Revenues

### Transportation Costs

Currently, King County contracts with a hauling company to drive 10 to 15 trucks of biosolids to eastern or western Washington land application sites from the treatment plants every day. The County owns a total of 35 trucks used for hauling and the County pays the contractor's hauling fees and fuel costs. Transportation costs highlighted in this section include hauling fees and fuel costs for the *Baseline: Class B*, *Alternative Option One: 100 Percent Class A*, and *Alternative Option Two: Pyrolysis*. These costs are included in the annual operating costs in Table 4, but are displayed separately for each option in Table 5, in millions of dollars.

*Baseline: Class B* assumes a continuation of the current hauling contract and has the highest transportation costs, due to the large proportion of product going to eastern Washington. *Alternative Option One: 100 Percent Class A* also assumes a continuation of the current hauling contract, but results in a lower transportation cost because the compost and soil blend products can be sold locally. *Alternative Option Two: Pyrolysis* has significantly lower transportation costs because, while a hauling contractor would still need to transport the biosolids from the treatment plants to an offsite pyrolysis facility, the distribution of the biochar product would be handled by a private business partner rather

than King County. This shifts the cost of transportation to the private partner, who could offset it through product sales and/or use it to negotiate the terms of the public-private partnership.

| Table 5. Summary of 2050 Annual Transportation Cost (in \$ millions) |                                   |
|--|-----------------------------------|
| Options  | Transportation (Hauling and Fuel) |
| Baseline Class B   | \$6.00                            |
| Alternative Option One: 100 Percent Class A                          | \$4.00                            |
| Alternative Option Two: Pyrolysis                                    | \$1.50                            |

Table 5: Summary of 2050 Annual Transportation Costs

### Non-monetary Costs and Benefits

King County’s capital and operating budget and project prioritization is informed by more than just monetary costs. It also includes qualitative costs, risks, and benefits that extend beyond economic considerations. To capture the non-monetary costs and benefits of each option, a greenhouse gas inventory and triple bottom line analysis were conducted.

#### Greenhouse Gas Inventory

Environmental benefits speak directly to several of King County’s priority initiatives, such as the [Strategic Climate Action Plan](#) and [Clean Water, Healthy Habitat](#). A greenhouse gas emissions inventory<sup>30</sup> was developed for each of the options based on the County’s flow and load projections for the 2050 annual average load at each regional treatment plant.<sup>31</sup> The inventory is based on greenhouse gas emitted during operation of the biosolids treatment facilities, transportation, and application of biosolids.

All options provide a net carbon credit, meaning they have the environmental benefits of having more carbon offsets and carbon sequestration than they do carbon emissions. Those net credits are shown in Figure 4 as credits, debits, and net credit in annual metric tons of carbon dioxide equivalent (mt CO<sub>2</sub>E) per year (yr). To put these carbon credits into every day metrics, the *Baseline: Class B* option takes the equivalent of 14,000 cars off the road each year, *Alternative Option One: 100 Percent Class A* takes the equivalent of 13,000 cars off the road each year, and *Alternative Option Two: Pyrolysis* takes the equivalent of 3,000 cars off the road each year.

The greenhouse gas emissions from each option, presented as negative carbon debits, include transportation, process fuel and chemical use, fugitive emissions<sup>32</sup>, and electricity consumption. The positive carbon credits come from electricity produced and sold, renewable natural gas production, carbon sequestration, and fertilizer offset from land application of biosolids.

<sup>30</sup> A greenhouse gas inventory is an accounting of greenhouse gas emissions and offsets. The greenhouse gas emission scopes and factors were based on the guidelines published by The Climate Registry (TCR) and Intergovernmental Panel on Climate Change (IPCC) and updated with recent publications.

<sup>31</sup> See King County Brightwater Treatment Plant Peak Flow and Wasteload Projections 2010-2060, 2019, King County. South Treatment Plant Peak Flow and Wasteload Projections 2010-2060, 2019, and King County. West Point Treatment Plant Peak Flow and Wasteload Projections 2010-2060, 2019 for more information.

<sup>32</sup> Fugitive emissions are emissions of gases or vapors from leaks or other unintended releases of gases from pressurized equipment.



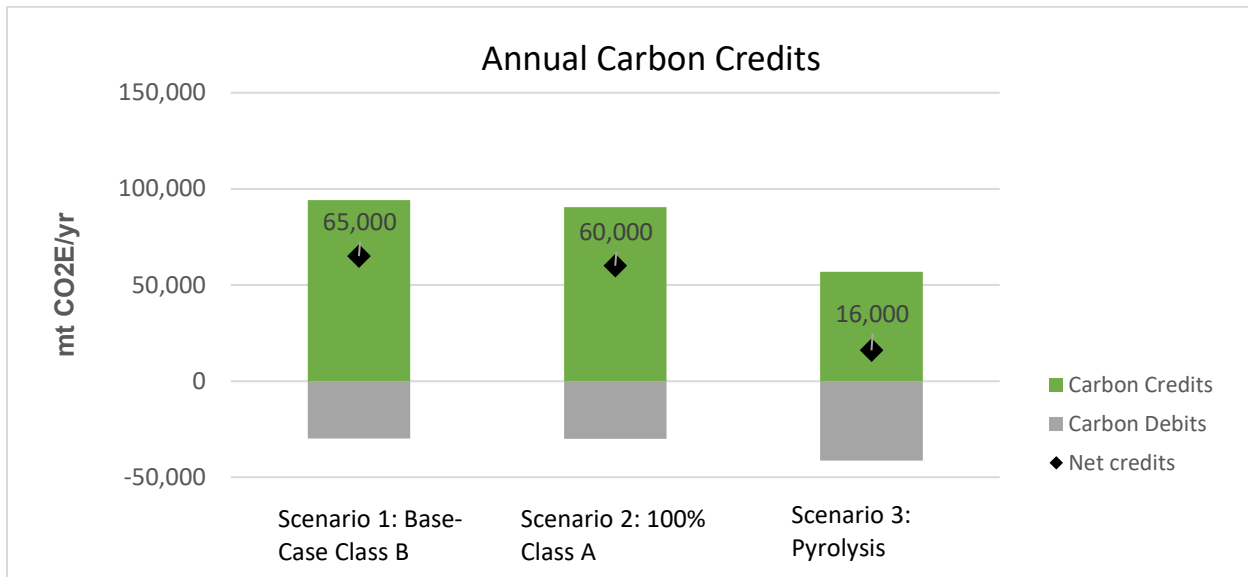

Figure 4: Annual Carbon Credits and Debits

#### Triple Bottom Line Analysis

Each option has differing environmental, equity, and social impacts. In order to capture the complexity of the costs and benefits of each option, a triple bottom line analysis was conducted. The three options were compared on a number of different environmental, social, and economic factors, such as traffic, odor, and noise increases, difficulty of implementation and operation, energy use, and market diversification. The weighted scores that are highest represent the best scenarios. Full triple bottom line results can be viewed in Appendix B.

The triple bottom line total score was very high for *Alternative Option One: 100 Percent Class A*, high for *Baseline: Class B*, and medium for *Alternative Option Two: Pyrolysis*.

- *Baseline: Class B* had high to very high scores in all criteria except flexibility to meet future regulations and market diversification/risk, both highly weighted criteria.
- *Alternative Option One: 100 Percent Class A* had the highest overall score due to very high scores in greenhouse gas emissions, flexibility to meet future regulations, market diversification/risk, and solids handling capacity. This scenario had high to very high scores in all other criteria, with the exception of noise, odor, traffic, and capital costs. Noise, odor, and traffic are equity impacts that would need to be considered and properly mitigated in the siting of a facility.

*Alternative Option Two: Pyrolysis* scored low to medium in each individual criteria category. Lower scoring criterion for pyrolysis included greenhouse gas emissions, energy use, regulatory compliance and beneficial use, capital cost, market risk/diversification, process reliability, and permitting.

### C. Physical Footprint

New offsite facilities would require acquiring land. For each option, the amount of land required, or the physical footprint of the site, was estimated as shown in Table 6. All footprints assumed in this analysis are approximate, since land acquisition and site selection is an in depth regulatory and community



process. Actual footprint size would be refined further if an option was implemented, as it would vary based on the specifics of the technology and actual site constraints for the land selected.

| Table 6. Physical Footprint (Land) Required |                 |
|---|-----------------|
| Options                                     | Number of Acres |
| Baseline: Class B                           | 0               |
| Alternative Option One: 100 Percent Class A | 30-40           |
| Alternative Option Two: Pyrolysis           | 12              |

Table 6: Physical Footprint (Land) Required

*Baseline: Class B* would require no additional land to continue Class B operations since there are no new offsite facilities and all changes are assumed to be at the treatment plant within the existing property boundaries.<sup>33</sup>

*Alternative Option One: 100 Percent Class A* would require a new offsite facility for composting and soil blending, since there is not enough space at any of King County's three treatment plants for this component. This facility would require 30-40 acres total.

- An offsite soil blending and compost facility would require 23 acres for the composting treatment process, which includes receiving feedstocks<sup>34</sup>, mixing feedstocks, composting, curing, screening, compost storage, and administrative buildings. The site would include a seven-acre buffer area to minimize any impacts to surrounding properties, with an additional 10 acres for soil blending and for product storage prior to retail sales, for a total of 40 acres.
- All other changes in this option are assumed to be made at the treatment plants within the existing property boundaries.

*Alternative Option Two: Pyrolysis* would require 12 acres total.

Due to existing space limitations at King County's three regional treatment plants, an off-site location would be required for a drying and pyrolysis system. An offsite pyrolysis facility processing 100 percent of King County's biosolids would require 12 acres to accommodate 12 belt dryers, three pyrolysis units, and ancillary equipment such as odor control, storage hoppers, conveyors, and boilers.

#### D. Storage Volume

The current King County Biosolids Program is designed to transfer biosolids from the treatment plants directly to land application sites for use as soon as the biosolids are fully treated. Biosolids are only temporarily stored in emergency situations when it is not possible to haul biosolids and/or land apply in either eastern or western Washington due to inclement weather and mountain pass closure. DNRP

<sup>33</sup> While the Brightwater and South treatment plants both have space allocated for additional digesters in their site footprint, there are competing space requirements from other high priority projects, such as the anticipated nutrient removal requirements being developed by the Washington State Department of Ecology. The West Point treatment plant is especially limited, with no additional acreage available and significant challenges working within the existing footprint.

<sup>34</sup> Feedstock refer to raw material used to supply or fuel an industrial process, such as composting.

contracts with the City of Everett Wastewater Treatment Plant to store biosolids at the facility during these weather events.

Temporary storage of biosolids requires an impermeable surface accessible by the trucks used for hauling, such as a paved area, and water runoff protections. The storage area at the City of Everett Wastewater Treatment Plant is a 60 foot by 100 foot paved space, which can hold approximately one week's worth of biosolids production from King County's three regional wastewater treatment plants. WTD can store approximately 100 truckloads (around 3,200 wet tons) on the site at a time. Biosolids are loaded into trucks at the treatment plant, hauled to the storage site, and unloaded. Stored biosolids are removed from the storage area and hauled to customers as soon as weather permits, generally within no more than a few days. In 2019, WTD took 88 loads to the storage area, totaling 2,775 wet tons. Over the last five years, WTD has sent on average 51 loads per year to the storage area and used no more than 44 percent of the total available space during peak storage times. Annual and future storage needs are difficult to predict, as they are determined by weather.

*Baseline: Class B* would require a similar temporary storage area or areas to the current City of Everett Wastewater Treatment facility space. *Alternative Option: 100 Percent Class A* would decrease storage needs, due to increased local hauling and diversity of products. In addition, the composting and soil blending facility proposed would be large enough to include a storage area similar to the current temporary storage option. Storage needs for *Alternative Option Two: Pyrolysis* would depend on the efficacy of the drying and pyrolysis equipment. Similar to *Alternative Option One: 100 Percent Class A*, the offsite pyrolysis facility could be designed to include temporary storage.

## E. Map of Biosolids Applications

The map below in Figure 5 shows the locations where customers use King County's Loop biosolids to grow their plants and crops, referred to as land application. The green icons show the forestry customers while the yellow icons show the agriculture customers, with major cities starred as geographic reference points.



Figure 5: Mapped Locations of Current Land Application of Biosolids shown with green and yellow icons. The Washington State Department of Natural Resource land and Snoqualmie Forest are in King County. Natural Selection Farms is in Yakima County. Boulder Park Inc. is in Douglas County and West Lincoln Project in Lincoln County.

## F. Financial Analysis

The financial analysis conducted shows that, regardless of Class B or A biosolids, significant investments are needed at all three treatment plants in the next 30 years to meet solids processing capacity needs for a growing population.

A summary explanation of how the options compare is below in Table 7.

| Table 7. Total Costs and Scores                                 |                   |   |                                   |
|---|-------------------|---|-----------------------------------|
|   | Baseline: Class B | Alternative Option One: 100 Percent Class A | Alternative Option Two: Pyrolysis |
| Estimated Escalated Capital Costs                               | \$335,000,000     | \$590,000,000                               | \$1,115,000,000                   |
| 2050 Annual Net Operating & Maintenance Costs and Minus Revenue | \$29,400,000      | \$29,500,000                                | \$28,500,000                      |
| Triple Bottom Line Score <sup>35</sup>                          | High              | Very High                                   | Medium                            |

Table 7: Total Costs and Scores

*Baseline: Class B* requires significant capital investment to maintain the existing system and address projected capacity needs. Biosolids are a byproduct of necessary sanitation and public health infrastructure so production is continuous and cannot be turned off or halted. If the County cannot beneficially use its biosolids due to unexpected circumstances, such as the sudden loss or inaccessibility of a customer, the cost to landfill is projected to be at least \$3 million per month due to hauling and landfill fees. Landfilling biosolids also requires a regulatory waiver and creates potential for regulatory fines.

*Alternative Option One: 100 Percent Class A* decreases the regulatory challenges and risk, because it can diversify the Loop product line with multiple Class A products (compost, soil blends, biosolids). Producing multiple products diversifies the biosolids program's customer base, a key strategic plan goal that will ensure the biosolids program can continue to meet its regulatory mandate to beneficially use biosolids. Implementing an option like *Alternative Option One: 100 Percent Class A*, thereby transitioning King County's entire biosolids program to Class A, would require a long-term, phased approach since it requires multiple large and expensive capital projects.

*Alternative Option Two: Pyrolysis* adds regulatory challenges and risk to the existing program by processing 100 percent of Loop at one off site facility, which does not provide programmatic redundancy or distribution options. The financial analysis demonstrated that *Alternative Option Two: Pyrolysis* is the highest cost option. In addition, biochar has a limited and uncertain market and is only considered Class A under the state biosolids rule on a case by case basis.

As indicated by WTD's [Clean Water Planning](#) efforts, there are many competing priority needs and the County must make the right investment according to its priorities. Therefore, any major capital investment, including transitioning King County's biosolids program to Class A, would require a long-term, phased approach over the next 30 years because of the cost and the need to prioritize capital investments. A phased approach maintains the existing Class B program while slowly adding Class A as it aligns with other organizational goals such as adding solids treatment capacity.

<sup>35</sup> For more information on Triple Bottom Line, see Appendix B.

## Conclusion

The study concluded that all future options, Class A or B, are costly and require significant technical and physical improvements. As digester capacity expansion is needed over the next 30 years at each of the regional treatment plants, opportunities to explore phased transition to Class A biosolids can be incorporated into planning efforts to address treatment capacity needs and maintain aging equipment.

Any development of a Class A program would require changes to biosolids policies in King County Code, since the King County Code currently prohibits the production and sale of anything other than Class B Biosolids.<sup>36</sup> WTD is currently in the process of designing a small-scale temporary compost pilot project at South Treatment Plant to test composting and explore marketability of a County-owned Class A compost. The current cost estimate for the pilot project is \$3.4 million with project completion anticipated in 2022/2023. This work in developing the pilot project to produce Class A compost at South Treatment Plant could help inform future planning efforts.

## Appendices

Appendix A: Technical Memorandum

Appendix B: Combined Financial, Environmental, and Social Costs and Benefits

---

<sup>36</sup> [King County Code 28.86.090 Biosolids policies \(BP\)](#).



701 Pike Street  
Suite 1200  
Seattle, WA 98101

T: 206.624.0100  
F: 206.749.2200

# Technical Memorandum

Prepared for: King County Wastewater Treatment Division

Project Title: System-Wide Treatment Plant Flow and Loading Study

Brown and Caldwell Project No.: 151084

## Technical Memorandum

Subject: Class A Biosolids Technology Evaluation

Date: April 20, 2020

To: Catherine Gowan, King County Biosolids Manager

From: Patricia Tam, Brown and Caldwell Project Manager

Copy to: Ashley Mihle, John Conway

Prepared by:   
\_\_\_\_\_  
Trung Le, Engineer III

Reviewed by:   
\_\_\_\_\_  
Steve Krugel, Senior Vice President

### Limitations:

*This document was prepared solely for King County Department of Natural Resources and Parks in accordance with professional standards at the time the services were performed and in accordance with the contract between King County Department of Natural Resources and Parks and Brown and Caldwell dated August 1, 2017. This document is governed by the specific scope of work authorized by King County Department of Natural Resources and Parks; it is not intended to be relied upon by any other party except for regulatory authorities contemplated by the scope of work. We have relied on information or instructions provided by King County Department of Natural Resources and Parks and other parties and, unless otherwise expressly indicated, have made no independent investigation as to the validity, completeness, or accuracy of such information.*

# Table of Contents

|   |    |
|---|----|
| Table of Contents .....   | i  |
| Section 1: Introduction.....                                      | 1  |
| Section 2: Technology Screening .....                             | 1  |
| 2.1 Biosolids Technology Screening Criteria.....                  | 2  |
| 2.1.1 Technology Maturity .....                                   | 2  |
| 2.1.2 Improved Processes and Existing Technology Enhancement..... | 3  |
| 2.1.3 Resource Recovery .....                                     | 3  |
| 2.1.4 Environmental Impacts .....                                 | 3  |
| 2.2 Biosolids Technology Screening Results .....                  | 3  |
| Section 3: Biosolids Technologies.....                            | 6  |
| 3.1 Anaerobic Digestion.....                                      | 6  |
| 3.1.1 Mesophilic Anaerobic Digestion.....                         | 6  |
| 3.1.2 Thermophilic Anaerobic Digestion.....                       | 6  |
| 3.1.3 Temperature-Phased Anaerobic Digestion .....                | 7  |
| 3.2 Digestion Pretreatment .....                                  | 8  |
| 3.2.1 Thermal Hydrolysis Process (THP) .....                      | 8  |
| 3.3 Product Enhancement Post-Digestion and Dewatering .....       | 9  |
| 3.3.1 Composting.....   | 9  |
| 3.3.2 Soil Blending and Manufactured Soils.....                   | 10 |
| 3.4 Other Stabilization Technologies .....                        | 10 |
| 3.4.1 Gasification and Pyrolysis .....                            | 10 |
| 3.4.2 Bioforcetech.....   | 15 |
| 3.4.3 Mass and Energy Balance.....                                | 16 |
| 3.4.4 Biochar .....   | 19 |
| Section 4: Development of Conceptual Scenarios.....               | 20 |
| 4.1 Flows and Loads .....   | 20 |
| 4.2 Scenario 1: Base-case .....                                   | 21 |
| 4.2.1 West Point.....   | 21 |
| 4.2.2 South Plant.....  | 22 |
| 4.2.3 Brightwater.....  | 22 |
| 4.3 Scenario 2: Enhanced Class A .....                            | 22 |
| 4.3.1 West Point.....   | 23 |
| 4.3.2 South Plant.....  | 23 |
| 4.3.3 Brightwater.....  | 23 |
| 4.3.4 Off-Site Composting Facility .....                          | 24 |
| 4.3.5 Off-Site Soil Blending Facility .....                       | 24 |
| 4.4 Scenario 3: Off-Site Pyrolysis.....                           | 25 |
| 4.4.1 West Point.....   | 26 |
| 4.4.2 South Plant.....  | 26 |



|   |     |
|---|-----|
| 4.4.3 Brightwater.....  | 26  |
| 4.4.4 Off-Site Pyrolysis facility.....  | 26  |
| 4.5 Scenario 4: Optimized Class A .....   | 27  |
| Section 5: Solids, Energy, and Greenhouse Gas Evaluation .....                      | 27  |
| 5.1 Mass and Energy Results .....   | 27  |
| 5.2 Greenhouse Gas Emission Results.....  | 28  |
| Section 6: Cost Assessment .....  | 30  |
| 6.1 Total Project Capital Costs .....   | 30  |
| 6.2 Operation and Maintenance Costs .....   | 31  |
| Section 7: Triple Bottom Line .....   | 33  |
| 7.1 Social and Equity Criteria Category.....  | 34  |
| 7.2 Environmental Criteria Category .....   | 34  |
| 7.3 Economic Criteria Category .....  | 35  |
| 7.4 Technical Criteria Category.....  | 35  |
| 7.5 TBL Score Summary.....  | 35  |
| Section 8: Conclusions.....   | 36  |
| Section 9: Sensitivity Discussion.....  | 37  |
| Attachment A: Solids-Water-Energy Evaluation Tool Design Basis and Assumptions..... | A-1 |
| Attachment B: Solids-Water-Energy Evaluation Tool Results.....                      | B-1 |
| Attachment C: Cost Estimating .....   | C-1 |
| Attachment D: Triple Bottom Line .....  | D-1 |

## List of Figures

|  |    |
|--|----|
| Figure 1. Thermophilic anaerobic digesters at Annacis Island WWTP.....                     | 7  |
| Figure 2. TPAD at Western Lake Superior Sanitary District WWTP .....                       | 8  |
| Figure 3. Cambi thermal hydrolysis process.....  | 8  |
| Figure 4. Basic configuration of a pyrolysis unit.....                                     | 11 |
| Figure 5. Basic configuration of a gasification unit.....                                  | 11 |
| Figure 6. Silicon Valley Clean Water Authority biosolids drying and pyrolysis system ..... | 16 |
| Figure 7. Diagram of mass and energy yield data at 500 °C.....                             | 17 |
| Figure 8. Bioforcetech pyrolysis system process schematic .....                            | 18 |
| Figure 9. Scenario 1: Base-Case .....  | 21 |
| Figure 10. Scenario 2: Enhanced Class A.....   | 23 |
| Figure 11. Example layout of an off-site Class A composting facility.....                  | 24 |
| Figure 12. Example layout of an off-site soil blending facility .....                      | 25 |
| Figure 13. Scenario 3: Off-site Pyrolysis .....  | 25 |
| Figure 14. Example layout of an off-site pyrolysis facility .....                          | 26 |
| Figure 15. Scenario 4: Optimized Class A.....  | 27 |
| Figure 16. Summary of GHG emissions.....   | 29 |



|  |    |
|--|----|
| Figure 17. Diagram of cash flow.....                 | 30 |
| Figure 18. Diagram of solids growth projections..... | 32 |

## List of Tables

|   |    |
|---|----|
| Table 1. Class A Technology Screening.....  | 4  |
| Table 2. Class A Technology Short List .....  | 5  |
| Table 3. Biosolids Pyrolysis and Gasification Projects .....                            | 12 |
| Table 4. Summary of Biochar Producers in the Pacific Northwest.....                     | 14 |
| Table 5. Pyrolysis and Gasification Company Consolidation and Bankruptcy.....           | 15 |
| Table 6. Mass and Energy Yield Data.....  | 17 |
| Table 7. Mass and Energy Yield Data Summarized from Bioforcetech Proposal.....          | 18 |
| Table 8. 2050 Annual Average Flows and Load.....  | 20 |
| Table 9. 2050 Max Month Flows and Load .....  | 21 |
| Table 10. Digester Peaking Factors .....  | 21 |
| Table 11. Summary of Mass and Energy Outputs from the SWEET (2050 Flows and Loads)..... | 28 |
| Table 12. Summary of GHG Emissions (2050 Flows and Loads) .....                         | 28 |
| Table 13. Summary of Capital Costs (in 2020 \$ millions).....                           | 30 |
| Table 14. Summary of Solids Growth.....   | 31 |
| Table 15. Summary of Net Present Value O&M and Revenues (in 2020 \$ millions).....      | 32 |
| Table 16. Summary of 2050 Annual O&M and Revenues (in \$ millions).....                 | 33 |
| Table 17. Social and Equity Criteria Category Scoring.....                              | 34 |
| Table 18. Environmental Criteria Category Scoring .....                                 | 34 |
| Table 19. Economic Criteria Category Scoring .....                                      | 35 |
| Table 20. Technical Criteria Category Scoring.....                                      | 35 |
| Table 21. Summary of Total TBL Scores.....  | 36 |

## Section 1: Introduction

The purpose of this technical memorandum (TM) is to document the supporting materials and results of the Class A biosolids technology evaluation prepared for King County (County). This TM was developed to assist the County in preparing their response to Council Proviso 2019-0148.P3 Version 2. The proviso calls for the identification of Class A alternatives to the current Class B biosolids application in forest and farm environments. The County is interested in diversifying the biosolids products to increase resiliency. This evaluation built upon the King County Treatment Plant Flows and Loadings Study. The previous evaluation identified and screened solids treatment technologies for each of the County's three regional treatment plants. Other earlier studies conducted for the County on Class A biosolids treatment alternatives were also used as background materials for this study.

This TM documents the following subtasks performed for this evaluation:

- Class A technology screening
- Overview descriptions of the short-listed technologies, including a more detailed description of the gasification/pyrolysis technology
- Development of biosolids treatment and reuse scenarios
- Conceptual modeling of each scenario to evaluate solids production, energy usage, and greenhouse gas (GHG) emissions.
- Development of conceptual capital and operating and maintenance (O&M) cost estimates
- Evaluation of the scenarios based on triple bottom line (TBL) criteria.

Preliminary results of the TBL evaluation were discussed in a review workshop with the County. This TM incorporates feedback from the County received at that workshop.

## Section 2: Technology Screening

The first task for this study was to pre-screen potential Class A technologies to identify those that could produce a Class A biosolids product. The approach used was to first synthesize previous studies on biosolids processing technologies and perform an initial screening for Class A technologies; this resulted in a comprehensive list of relevant Class A technologies. Screening criteria were developed to further reduce the selection of Class A technologies to those potentially suitable for County biosolids management.

The following documents were used as references:

- King County Treatment Plant Flows and Loadings Study King County Biosolids Strategic Plan 2016 – 2037
- King County 2005 Class A Biosolids Workplan

The draft biosolids technology evaluation from the King County Treatment Plant Flows and Loadings Study, was used as the starting point for this evaluation with some modifications as described in the following sections below.

## 2.1 Biosolids Technology Screening Criteria

Four categories of screening criteria were developed and include:

- Technology maturity
- Improved process
- Resource recovery
- Environmental impacts

Details of each category are described below.

### 2.1.1 Technology Maturity

Technology maturity relates to the state of development and implementation of a given technology and is directly related to the risk/reliability of its adoption. The use of non-established technologies typically has a high degree of risk related to failure in the successful application of the technology and in meeting the required performance. Given these risks, non-established technologies were screened from the evaluation.

The implementation of international technologies in the U.S. poses challenges that are related to differences in regulations, materials and feedstocks, design standards, and market drivers. International technologies require adaption to U.S. standards and environment, which generally correlates to additional costs. A steeper learning curve may also result from being the first/early adopter of international technologies. Due to the increase in the risk of failure in meeting performance, international technologies that have no U.S. implementations were screened from the evaluation.

This analysis is based on the most current available information. The technology market for biosolids is constantly changing and adapting to new technology developments, maturation of technologies, and the discontinuation of others. Reassessing current non-established and non-U.S. implemented technologies in the future may result in these technologies advancing for further consideration. The three tiers of technology maturity used in this evaluation include:

- **Established:** This tier represents technology that has been well-established in the industry for solids processing applications; these technologies have broad usages with long records of performance.
- **Non-established:** This tier represents technologies that fall within the two following categories:
  - **Embryonic:** This first tier represents technology in its early development state or that has been demonstrated at bench or small pilot scales in a laboratory environment. In some cases, an embryonic technology may be proven at full scale with a different feedstock, but not with wastewater sludge. It may be in operation at one or two full-scale plants for a short duration but has not achieved a long-term proven status; therefore, technologies deemed embryonic were eliminated from further consideration.
  - **Innovative:** Innovative technology is commercially viable and has been proven at full scale in one or more installations. Innovative technologies have a shorter track record of reliable operation than established technologies (e.g., typically less than 5 years).
- **U.S. Implementation:** Many wastewater technologies have a global presence and the exchange of technologies internationally is common practice. When foreign technologies established in other markets enter the U.S. market, critical technical challenges can arise as well as issues with navigating and receiving approval from U.S. regulatory agencies. This presents a potential risk that can have negative and costly consequences for implementation.

### 2.1.2 Improved Processes and Existing Technology Enhancement

Improved processes and existing technology enhancement are summarized as follows:

- **Improved processes:** Technologies categorized as improved processes include those that will improve current solids treatment performance. For example, improvements can include increased process efficiency, increased digester gas production, reduced power and polymer consumption, resource recovery, improved biosolids product quality, and a reduced required quantity of solids. Current solids treatment technologies at each WWTP have been proven acceptable under current conditions and are designated as the baseline case (existing) scenario technology. Any technology that will likely degrade performance from the baseline case was eliminated from further consideration.
- **Existing technology enhancement:** Technologies in this category are optimization strategies that can improve overall process performance while using existing infrastructure. These require minor infrastructure modifications or minor new component additions without adding major new process tankage.

### 2.1.3 Resource Recovery

Resource recovery relates to the beneficial use of biosolids and digester gas:

- **Class A biosolids:** This comprises technologies that produce Class A biosolids with one of U.S. Environmental Protection Agency's (EPA) Process to Significantly Reduce Pathogens processes or that have achieved Class A equivalency. This does not include technologies that can potentially produce biosolids products meeting Class A requirements but require site-specific equivalency determination and/or daily pathogen monitoring/reporting to prove compliance on each biosolids batch.
- **New biosolids product:** These technologies produce biosolids products other than dewatered Class B cake, which is currently produced at the County's WWTPs.
- **More gas production:** These technologies increase digester gas production over conventional mesophilic digestion. All major County plants currently produce and beneficially use digester gas. Increased digester gas production can be achieved by digester pretreatment and/or advanced digestion processes. Technologies that reduce or eliminate gas production were eliminated from further consideration.

### 2.1.4 Environmental Impacts

Environmental impacts include the impact on GHG emissions from the solids treatment processes. GHG emissions reductions can be achieved by reducing power and chemical consumption, increasing digester gas production, increasing or providing a higher level of beneficial use for digester gas, or reducing vehicle fuel consumption. BC eliminated technologies that significantly increase GHG emissions from further consideration.

## 2.2 Biosolids Technology Screening Results

The criteria established in **Section 2.1** were used to perform a technology screening. **Table 1** shows the preliminary technology screening results. This screening table originated from work completed for the King County Treatment Plant Flows and Loadings Study and was adapted for this study as described below. Technologies with acceptable maturity (or will have beneficial impacts over existing processes) were given a "✓" mark on that criterion. Technologies with detrimental impacts (as described above) are given an "x" mark on that criterion. Table cells were left blank where the technology was neutral or not applicable with respect to the criterion. Any technology with an "x" in any criterion was eliminated from further evaluation and shown as shaded cells in **Table 1** below.

Table 1. Class A Technology Screening

| Parameter   | Solids Processing Technologies  |                       |                    |                  |                       |                   |                       |                       |
|---|---|-----------------------|--------------------|------------------|-----------------------|-------------------|-----------------------|-----------------------|
|   | Technology  | Technology Maturation |                    | Improved Process | Resource Recovery     |                   |                       | Environmental Impacts |
|   |   | Established           | U.S. Installations | Improved Process | Existing Enhancements | Class A Biosolids | New Biosolids Product | More Gas Production   |
| Anaerobic Digestion                               | Conventional Mesophilic Anaerobic Digestion (CMAD) (baseline case South Plant, West Point, Brightwater) | ✓                     | ✓                  |                  |                       | X                 |                       |                       |
|   | Conventional TAD or TPAD with Batch Tanks   | ✓                     | ✓                  | ✓                | ✓                     | ✓                 | ✓                     | ✓                     |
|   | Acid/Gas Anaerobic Digestion (AGAD)   | ✓                     | ✓                  | ✓                |                       | X                 |                       | ✓                     |
|   | Post Aerobic Digestion (PAD)  | X                     | ✓                  | ✓                |                       | X                 |                       | X                     |
|   | Dual digestion (ATAD plus thermophilic anaerobic)   | ✓                     | ✓                  | X                | X                     | ✓                 | ✓                     | X                     |
|   | Recuperative thickening (e.g., OMNIVORE™)   | X                     | ✓                  | ✓                | ✓                     | X                 |                       |                       |
| Digestion Pretreatment                            | Thermal hydrolysis (Cambi)  | ✓                     | ✓                  | ✓                |                       | ✓                 | ✓                     |                       |
|   | Thermal hydrolysis (Biothelys™, Exelys™, LysoTherm®, Haarslev™)   | X                     | X                  | ✓                |                       | ✓                 | ✓                     |                       |
|   | Thermal-chemical hydrolysis (PONDUS)  | X                     | ✓                  | ✓                |                       | X                 |                       | ✓                     |
|   | Enzymatic hydrolysis (Monsal)   | X                     | X                  | ✓                |                       | X                 |                       | ✓                     |
|   | Mechanical (Crown)  | X                     | X                  | ✓                |                       | X                 |                       | ✓                     |
|   | Ultrasonic (sonix™, Sonolyzer®)   | X                     | X                  | ✓                |                       | X                 |                       | ✓                     |
|   | Electrokinetic (BioCrack)   | X                     | X                  | ✓                |                       | X                 |                       | ✓                     |
| Other Stabilization Technologies                  | Alkaline stabilization  | ✓                     | ✓                  | X                |                       | ✓                 | ✓                     | X                     |
|   | Incineration with power generation  | ✓                     | ✓                  | X                |                       | X                 |                       | X                     |
|   | Compositing (raw sludge)  | ✓                     | ✓                  | X                |                       | ✓                 | ✓                     | X                     |
|   | Thermal drying (raw sludge)   | ✓                     | ✓                  | X                |                       | ✓                 | ✓                     | X                     |
|   | Gasification/pyrolysis  | X                     | ✓                  |                  |                       | — <sup>2</sup>    | ✓                     | X                     |
|   | Hydrothermal oxidation (AquaCritox®)  | X                     | X                  |                  |                       |                   | ✓                     | X                     |
|   | Hydrothermal liquefaction-gasification (Genifuel Corporation)   | X                     | X                  |                  |                       |                   | ✓                     | X                     |
| Product Enhancement Post-Digestion and Dewatering | Thermal drying  | ✓                     | ✓                  | X                |                       | ✓                 | ✓                     | X                     |
|   | Solar Drying  | ✓                     | ✓                  | X <sup>1</sup>   |                       | ✓                 | ✓                     |                       |
|   | Thermal-chemical hydrolysis (Lystek)  | X                     | ✓                  | X                |                       | ✓                 | ✓                     |                       |
|   | Composting  | ✓                     | ✓                  | ✓                |                       | ✓                 | ✓                     |                       |
|   | Soil blending, Post Class A Digestion   | ✓                     | ✓                  | ✓                |                       | ✓                 | ✓                     |                       |

<sup>1</sup> Solar drying is only feasible in eastern Washington due to the lower solar radiation of the region. Auxiliary heating in terms of natural gas would be needed to supplement drying requirements.

<sup>2</sup> The Washington Department of Ecology (Ecology) does not have a policy that covers pyrolysis and will require a review of Class A designation for these systems on a case by case bases.

<sup>3</sup> Some gasification and pyrolysis systems can become energy neutral or positive based on the dry solids content of the dewatered cake entering the system. The Bioforcetech system evaluated was paired with a belt dryer rather than a biodryer based on the manufacturer's recommendation. This pairing resulted in the system requiring external energy input.

Several changes were made to the draft biosolids technology evaluation prepared during the King County Treatment Plant Flows and Loadings Study and are noted below:

1. Added Class A solar drying to the list based on its inclusion in the evaluation from the *KC Strategic Plan 2018-2037*
2. TAD and TPAD alternatives were combined with batch tanks as one alternative.
3. The ATAD component of Dual Digestion does not produce gas and requires significant additional energy to digest. TAD/TPAD with batch tanks represents a better alternative for enhanced Class A digestion for County plants.
4. Cambi thermal hydrolysis process (THP) is the only THP technology with a U.S. Installation. Cambi will be the representative technology for THP.
5. Class A Biosolids was updated to be a screening criterion
6. U.S. Installations was added as a screening criterion
7. PAD was updated with an **X** for GHG due to energy use for aeration
8. Thermal drying was updated with an **X** for improved process due to increase in energy use
9. Thermal-Chemical Hydrolysis (Lystek) was updated with an **X** for improved process due to the creation of a liquid product that would require additional trucking and application, not consistent with County product goals
10. Off-site and on-site designations were removed to be more generic for soil blending and composting

A short-list of the technologies remaining after this screening process is shown in **Table 2**. All technologies that received negative marks in any criterion were removed from further consideration. Pyrolysis did not meet the specified criteria for screening but was included in the evaluation due to interest from the County Council.

**Table 2. Class A Technology Short List**

| Parameter   | Solids Processing Technologies  |                       |                    |                  |                       |                   |                       |                       |
|---|---|-----------------------|--------------------|------------------|-----------------------|-------------------|-----------------------|-----------------------|
|   | Technology  | Technology Maturation |                    | Improved Process | Resource Recovery     |                   |                       | Environmental Impacts |
|   |   | Established           | U.S. Installations | Improved Process | Existing Enhancements | Class A Biosolids | New Biosolids Product | More Gas Production   |
| Anaerobic Digestion                               | Conventional Mesophilic Anaerobic Digestion (CMAD) (baseline case South Plant, West Point, Brightwater) | ✓                     | ✓                  |                  |                       | X                 |                       |                       |
|   | Conventional TAD or TPAD with Batch Tanks   | ✓                     | ✓                  | ✓                | ✓                     | ✓                 | ✓                     | ✓                     |
| Digestion Pretreatment                            | Thermal hydrolysis (Cambi)  | ✓                     | ✓                  | ✓                |                       | ✓                 | ✓                     |                       |
| Other Stabilization Technologies                  | Gasification/pyrolysis  | X                     | ✓                  |                  |                       | - <sup>1</sup>    | ✓                     | X                     |
| Product Enhancement Post-Digestion and Dewatering | Composting  | ✓                     | ✓                  | ✓                |                       | ✓                 | ✓                     |                       |
|   | Soil blending, Post Class A Digestion   | ✓                     | ✓                  | ✓                |                       | ✓                 | ✓                     |                       |

<sup>1</sup> Ecology does not have a policy that covers pyrolysis and will require a review of Class A designation for these systems on a case by case bases.

<sup>2</sup> Some gasification and pyrolysis systems can become energy neutral or positive based on the dry solids content of the dewatered cake entering the system. The Bioforcetech system evaluated was paired with a belt dryer rather than a biodryer based on the manufacturer's recommendation. This pairing resulted in the system requiring external energy input.

## Section 3: Biosolids Technologies

This section provides a brief overview of the short-listed technologies. A longer discussion on pyrolysis technologies is included and covers the status of the technology and the biochar market. This discussion was not included in the previous evaluation under Task 450 as it had not passed the technology screening.

### 3.1 Anaerobic Digestion

#### 3.1.1 Mesophilic Anaerobic Digestion

Mesophilic anaerobic digestion (MAD) is the most commonly used anaerobic digestion process in the U.S. Mesophilic digesters are operated within the mesophilic temperature range, 95 to 102 degrees Fahrenheit (°F), at solids retention times (SRTs) exceeding 15 days. Typically, loading criteria range from 100 to 160 pounds of volatile solids (lb-VS) per 1,000 cubic feet (ft<sup>3</sup>) per day (d) with limiting loadings rates of 200 lb-VS/1,000 ft<sup>3</sup>/d. The process produces substantial methane-rich digester gas that has high thermal value and is commonly used as a renewable fuel.

Mesophilic digestion produces a Class B biosolids as defined by the U.S. Environmental Protection Agency's (USEPA) Part 503 regulations and is suitable for most large-scale agricultural, forest, and mine reclamation applications. Class B biosolids have some application restrictions to protect public health and safety.

#### 3.1.2 Thermophilic Anaerobic Digestion

Thermophilic anaerobic digestion (TAD) occurs at temperatures between 120 and 135 °F, at conditions suitable for thermophilic microorganisms. Biochemical reactions increase with temperature; therefore, microbial reactions in TAD are much faster than mesophilic digestion. The advantages of TAD include increased solids destruction capability, improved dewatering, increased gas production, and increased pathogen destruction. Because of the increased biochemical reaction rate, loadings to a TAD have been reported as high as 500 lb-VS/1,000-ft<sup>3</sup>/d, significantly higher than those of MAD.

Disadvantages of TAD include higher energy requirements for heating, poorer supernatant quality, and higher dewatering odor requiring treatment. In addition, thermophilic dewatered cake has slightly higher initial end product odor due to higher ammonia that dissipates relatively quickly. Higher solids destruction rates in a thermophilic digester release greater concentrations of ammonia which contributes to the poorer supernatant quality, potentially impacting the plant's liquids steam processes. TAD also requires additional heat exchangers and heat resources relative to MAD to heat the digester to higher temperatures; however, heat recovery systems can greatly reduce heating costs. **Figure 1** is a photograph of the TAD operated by Metro Vancouver at the Annacis Island Wastewater Treatment Plant (WWTP) in Delta, British Columbia.





**Figure 1. Thermophilic anaerobic digesters at Annacis Island WWTP**

If properly configured, TAD can produce Class A biosolids. To prevent the potential for short-circuiting and increased pathogen levels above the Class A criterion in the biosolids, batch tanks are often used. The wastewater solids are held in a batch tank for a set period of time (24 hours hold time required for Class A at 131 °F) to prevent the opportunity for any solids to pass through the entire digestion process in a shorter time period than required (i.e., short-circuiting the process). To meet USEPA requirements for Class A biosolids, separate batch tanks (or batch operation of the digesters) would need to be included with a TAD process. Without batch operation, the biosolids from the TAD process operated at higher temperatures and configured properly can potentially produce biosolids that meet Class A requirements for pathogen reduction, but would require testing of each biosolids batch.

### 3.1.3 Temperature-Phased Anaerobic Digestion

Temperature-phased anaerobic digestion (TPAD) incorporates the advantages of TAD and mitigates some of the disadvantages through the incorporation of MAD to improve performance. TPAD uses digesters in series, where the first stage is thermophilic followed by a mesophilic stage. The high biochemical reaction rate in the thermophilic phase improves solids destruction capability, improves dewaterability of the sludge, increases gas production, and increases pathogen destruction rates. The following mesophilic stage(s) improves the performance of the overall digestion system and helps mitigate the disadvantages of TAD (specifically, poorer supernatant quality and odors). The higher temperature of the thermophilic stage and configuration's ability to minimize short-circuiting contributes to greater pathogen destruction. As with TAD, TPAD can be configured with batch tanks to produce Class A biosolids. Also similar to TAD, a greater number of heat exchangers and heat resources are required to heat the wastewater solids to thermophilic temperatures and then cool the solids to mesophilic temperatures. **Figure 2** is a photograph of the TPAD system at Western Lake Superior Sanitary District's WWTP in Duluth, Minnesota.





Figure 2. TPAD at Western Lake Superior Sanitary District WWTP

## 3.2 Digestion Pretreatment

### 3.2.1 Thermal Hydrolysis Process (THP)

Class A THP is a mature technology in Europe and worldwide with full-scale facilities in service since 1995; the first installation in the U.S. (Blue Plains plant in Washington, DC) has been operating since late 2014 and other U.S. installations are in the planning, design, and construction phases. THP is a pretreatment process prior to anaerobic digestion. There are two primary manufacturers of Class A THP – Cambi and Veolia. Class A THP uses medium-pressure steam to create high temperature and pressure conditions, which lyse (break open) bacterial cells and promote the release and solubilization of particulate organic material, making the feed solids more amenable to digestion. **Figure 3** depicts a typical process flow of the Cambi Class A THP system for pretreatment of wastewater solids before digestion.

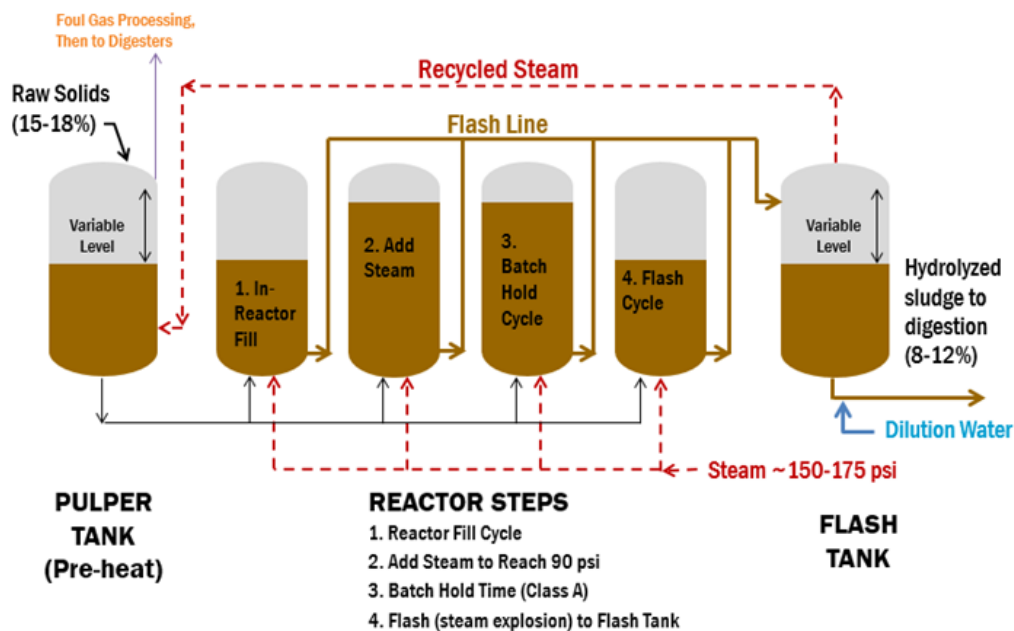

Figure 3. Cambi thermal hydrolysis process



THP systems can approximately double conventional MAD organic loading rates because of the modified characteristic of the feedstocks. This more efficient use of digester volume reduces the number of digesters required. Ancillary buildings and equipment are required to operate a THP system, including steam boilers, solids screening, pre-dewatering, raw cake storage and pumping, and solids dilution and cooling systems. While THP systems can reduce the required digester volume, the ancillary systems impact total system cost, complexity, and footprint.

The vast majority of Class A THP systems have been implemented by Cambi. However, competitor THP systems (Biothelys™, Exelys™, LysoTherm®, Haarslev™) have been installed in Europe, and Veolia's Biothelys system has been installed in the United Kingdom. Due to the lack of U.S. installations from THP manufacturers, this evaluation will use Cambi's THP system as the representative technology for THP systems alternatives.

### **3.3 Product Enhancement Post-Digestion and Dewatering**

#### **3.3.1 Composting**

Composting is the most common method used to produce Class A biosolids in the U.S. To meet the criteria for Class A, composted biosolids must meet regulated metals, pathogen and vector attraction reduction limits, comply with required sampling and analysis protocols, maintain compost temperature and retention time records, and meet product labeling requirements.

Digested biosolids dewatered cake can be composted with sawdust, wood chips, yard clippings, storm debris, food waste, manure or crop residues, and food processing wastes. The final composted product provides nutrients and organic matter and sequesters carbon, thereby conserving resources, restoring soils, and combating climate change. Additionally, composting has been a long used process to reduce environmental contaminants. Research and composting applications have shown that aerobic composting can be effective at reducing antimicrobial resistant genes/bacteria and organic pollutants (Semple et al., 2001; Youngquist et al., 2016; Ozaki et al., 2017).

Composted biosolids are used in agriculture, horticulture, and landscaping just like any other retail soil product. Professional landscapers and master gardeners use composted biosolids for landscaping new homes and businesses. Home gardeners also find composted biosolids to be an excellent alternative to typical fertilizer.

Many composting technologies are available in the market and can vary from low-tech with limited process control to high-tech with precise process control. Many of these technologies can improve the composting process by providing better control of environmental factors, aeration rates, temperature, etc. In-vessel composting is one such method that uses silos, structures, plastic material, or other physical barriers to improve the composting process. Generally, these technologies provide the best composting process with the most efficient use of space and overall best product quality. Windrow composting is the most simplistic and widely used composting method. Windrow composting uses long rows and short piles of mixed biosolids and organic material that are mechanically aerated with a front-end loader or a windrow turner. This method is typically less controlled, uses a significant amount of space, and requires greater manual labor. Aerated static pile (ASP) composting is a high-rate composting method that sits between windrow and in-vessel composting. It is more compact and can be covered or uncovered. Piles or windrows are placed on top of porous bulking agents like wood chips with channels or pipes that provided negative or positive forced aeration through the piles while removing process water. ASPs are the second most widely used composting system and commonly used for biosolids composting.

### 3.3.2 Soil Blending and Manufactured Soils

Soil blending can be used to improve overall product quality or to change the product characteristics by blending biosolids with other organic and inorganic materials. However, the feedstock to any soil blending operation must be a Class A biosolids cake. These manufactured soils can be formulated to provide specific characteristics for unique applications and to reach a wider market through product diversification. Soil blended products can be publicly distributed in bag or bulk form. Generally, public reception of blended products tends to be positive due to similarities with existing non-biosolids soil conditioning products and reduced odors. The City of Tacoma produces several blended products including their most popular product, TAGRO Classic, which is comprised of two parts Class A dewatered cake, two parts sawdust, and one-part sand. Other blended products that are offered include mulch products that contain 80 percent woodchips and 20 percent biosolids and a potting soil mix of 20 percent biosolids, 20 percent maple sawdust, and 60 percent clean, aged bark. TAGRO has been largely successful with their blended products with demand often exceeding supply.

## 3.4 Other Stabilization Technologies

### 3.4.1 Gasification and Pyrolysis

Gasification and pyrolysis are technologies that have been widely used in other industries, principally using wood waste as a carbon source, but with very limited applications in the wastewater/biosolids industry. The following sections provide a description of the technologies and a discussion of the status of their development.

#### 3.4.1.1 Technology Description

Pyrolysis is the thermal decomposition and partial mineralization of carbonaceous materials occurring in an anaerobic environment. Thermal decomposition typically occurs at temperatures in excess of 300 °C. The anaerobic environment can promote the breakdown of carbon-rich feedstocks into an energetically favorable endpoint (e.g. methane) to generate a modest amount of combustible gas called syngas or pygas. The condensable fraction of the syngas can be stored and used as a liquid fuel and is often referred to as bio-oil. The remaining solid residue is a high-value product called biochar. Biochar has a thermal value similar to coal, functions as an adsorbent like activated carbon, and can also be used as a soil conditioner to improve overall soil health. A basic configuration of a pyrolysis unit and its major components is provided below in Figure 4.

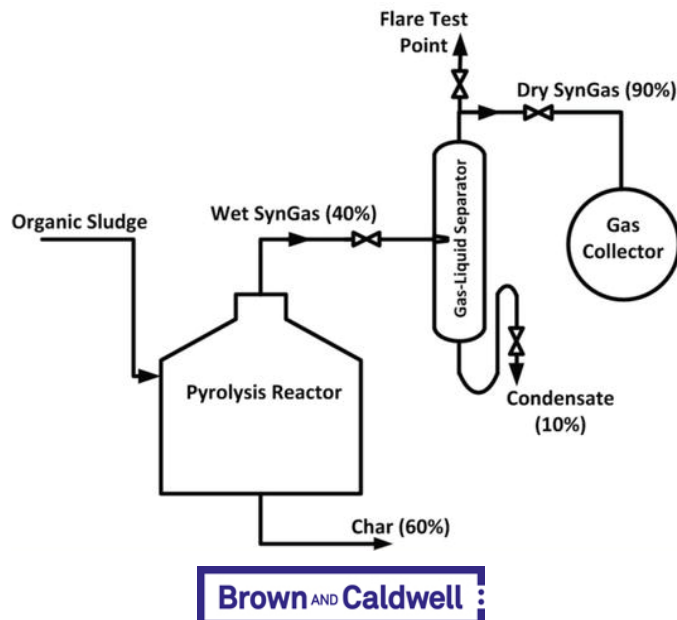

**Figure 4. Basic configuration of a pyrolysis unit**

The advantages of pyrolysis include residuals volume reduction, the potential for net energy production, carbon fixing into a stable form in biochar, and generation of a value-added product in biochar. In addition to the various end uses for biochar, research has also demonstrated the removal of contaminants of emerging concern such as triclosan and nonylphenol to non-detect levels during pyrolysis (Lee et al., 2018; Paz-Ferreiro et al., 2018; Ross et al., 2016). While pyrolysis itself can be energy positive, it requires prior biosolids drying to 60 to 90 percent total solids, requiring a substantial increase in energy input and representing a substantial additional investment in capital outlay and operational and maintenance costs for the biosolids dryer. As described further below, biochar management contracts are now commercially available at no cost to the generator with opportunities for revenue sharing.

Pyrolysis is often linked with gasification, which is another thermal process that combines the thermal decomposition step of pyrolysis with a controlled oxidation zone where limited air, oxygen, or steam is added to partially oxidize the volatilized organics. In gasification, the oxidation zone is consequently followed by a reductive zone where further cracking and reforming of the gases takes place to produce a syngas made up of lighter hydrocarbons compared to that of pyrolysis, with a smaller condensable fraction. While the condensable fraction of pygas has an energetic value and has been successfully processed into a usable liquid fuel with various feedstocks, it is highly acidic and unstable when heated making it difficult to handle. A basic configuration of a gasification unit and its major components is provided below in **Figure 5**.

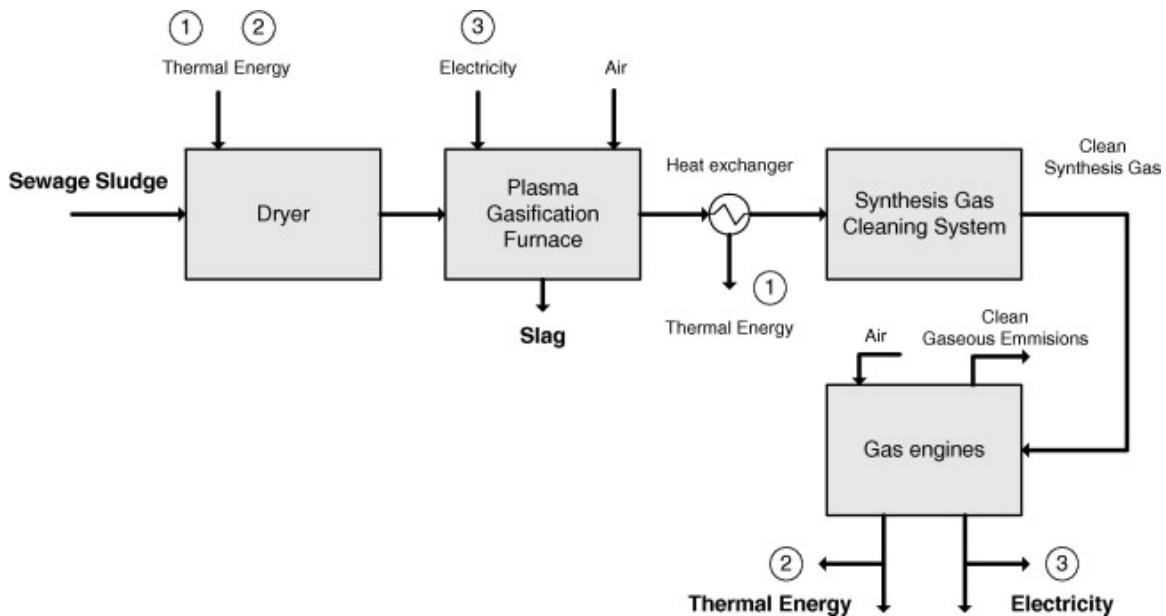
**Figure 5. Basic configuration of a gasification unit**

### 3.4.1.2 State of Technology

Applications of biosolids-based pyrolysis and gasification systems have been extremely limited due to the high technical risks, large capital cost, and the additional research and process adaption that is required when transferring technologies from other industries. The non-homogenous characteristics of biosolids, which can fluctuate in the amount of organic and inorganic content, can result in operational challenges. These challenges include impacts to the energy balance of the system requiring external natural gas or the addition of wood feedstocks to prevent interruption in the pyrolysis process. These conditions could dramatically increase operational costs and reduce the overall reliability of the system. The variations in the characteristics of biosolids may also change final product quality and increase the corrosion of the systems

which would require additional maintenance. These factors can impact the long-term success of programs and can result in failure which is further discussed in **Section 3.4.1.6**.

Only three biosolids pyrolysis/gasification facilities are operational in the U.S. with the largest facility processing 7,000 wet tons per year. This facility represents only 6 percent of the biosolids produced from the County's biosolids management program. This is out of a total of 33 U.S. gasification and pyrolysis facilities, where the other 30 plants process other feedstocks such as wood waste into syngas and biochar. The limited number of facilities suggests that the technology remains an emerging technology with needs for a longer operation history, more research, and additional installations.

**Table 3** below lists identified projects currently in operation, taken out of service, or are under planning, design, or construction.

| Table 3. Biosolids Pyrolysis and Gasification Projects |   |                            |                               |                        |                     |                          |                            |
|--|---|----------------------------|-------------------------------|------------------------|---------------------|--------------------------|----------------------------|
| Company  | Facility                                  | Location                   | Feedstock                     | Type                   | Scale               | Status                   | Biosolids Capacity (WT/Yr) |
| Aries Clean Energy                                     | Linden Roselle Sewerage Authority complex | Linden, New Jersey         | Biosolids                     | Gasification/Pyrolysis | Full-scale          | Q4 2020                  | 130,000                    |
| Aries Clean Energy                                     | Lebanon Waste-to-Energy Plant             | Lebanon, Tennessee         | Woodwaste and biosolids       | Gasification/Pyrolysis | Full-scale          | 2016 - present           | 1,095                      |
| Aries Clean Energy                                     | City of Covington                         | Covington, Tennessee       | Woodwaste and biosolids       | Gasification/Pyrolysis | Full-scale          | 2014 - present           | 730                        |
| Aries Clean Energy                                     | Aries-Holloway Bioenergy Facility         | Lost Hills, California     | Agricultural biomass          | Gasification/Pyrolysis | Full-scale          | Q3 2021                  | 60,225                     |
| Max West   | Sanford Utility Department                | Sanford, Florida           | Biosolids                     | Gasification/Pyrolysis | Full-scale          | 2009-2014 decommissioned | 14235                      |
| Bioforcetech   | Silicon Valley Clean Water                | Redwood City, California   | Biosolids                     | Pyrolysis              | Full-scale          | 2017 - present           | 7000                       |
| Bioforcetech   | Edmonds Wastewater Treatment plant        | Edmonds, Washington        | Biosolids                     | Pyrolysis              | Full-scale          | 2021                     | -                          |
| Anaergia   | Rialto Bioenergy Facility                 | San Bernardino, California | Biosolids and foodwaste (70%) | Pyrolysis              | Full-scale          | 2020                     | 109,500                    |
| Anaergia   | Encina Wastewater Authority               | Carlsbad, California       | Biosolids                     | Pyrolysis              | Pilot/demonstration | 2014                     | -                          |
| KORE Infrastructure                                    | LACSD joint Water Pollution Control Plant | Carson, California         | Biosolids                     | Pyrolysis              | Pilot/demonstration | 2008-2015                | 1000                       |

The chemical, material, and energy industries have shown a growing demand for investments in pyrolysis and gasification plants as a means for the development of alternative fuels and carbon products. Approximately 272 gasification plants are in operation worldwide and 74 additional plants are under construction based on a 2014 update of the gasification facilities database by Global Syngas Technologies Council. According to some research studies, the global market for biochar is expected to increase to the range of \$653M-\$3,100M by 2027 (TechSci Research, 2019; Research Nester, 2018). The largest growth in pyrolysis/gasification applications can be seen in the use of agriculture waste, biomass, organics, plastic/tire, and coal to produce renewable natural gas production, biochar, and bio-oil. Recent bans in international recycling outlets for plastics has also seen an increase in investment in plastics-to-oil solutions. In the last decade, the aviation industry has begun a campaign to decarbonize air travel by using sources for renewable aviation fuel (IRENA, 2017). All of these market drivers have spurred the rapid development of the pyrolysis and gasification industry.



### 3.4.1.3 European and International Applications

The adoption of pyrolysis and gasification technologies in Europe has advanced more rapidly than the U.S. No other international applications could be found outside of Europe and the U.S. In Europe, the use of pyrolysis and gasification technologies has been limited to the energy, materials, and forestry industry. Similar to the U.S., there are limited applications of pyrolysis and gasification of biosolids. Less than a dozen facilities use biosolids as a feedstock and are primarily small scale facilities. Europe's application of biosolids pyrolysis and gasification can be classified as emerging and likely faces similar risks and regulatory development requirements as the U.S.

### 3.4.1.4 United States Applications

Gasification has been evaluated with different feedstocks over the past few decades and has faced a number of historical operational challenges including concerns for dioxin formation in oxygenated pockets, difficulty in scaling reactors, and deformation or slag formation from residual product within the reactor. The most recent example of full-scale biosolids gasification occurred at the Maxwest Sanford Florida facility that operated from 2009 to 2014. The system operated as a 20-dry ton per day regional biosolids receiving and processing facility; however, the system was never able to achieve the targeted operational efficiency or reliability and was decommissioned. The technology has since been sold to a new company, Aries Clean Energy, who successfully operates two full-scale gasifiers that run on a combined feedstock of wood waste and biosolids. These facilities process only a fraction of biosolids compared to wood-waste and more details can be seen in **Table 3**. Aries Clean Energy recently obtained funding and has started construction of a regional biosolids gasification facility in Linden, New Jersey.

Pyrolysis has been evaluated at a number of facilities at pilot scale, including Los Angeles, California by Kore Infrastructure and Encina, California by Anaergia. The first full-scale biosolids pyrolysis unit was commissioned in June 2017 at the Silicon Valley Clean Water Authority in Redwood, California. The unit was supplied by Bioforcetech, an Italy-based technology provider, and is capable of processing 1,300 pounds of dry biosolids product per hour. The unit was approved by EPA as a non-incineration process and permitted by the Bay Area Air Quality Management District as a process heater. Regulations for biosolids biochar are currently undefined. Washington state approval for a Class A biosolids product will be on a case by case basis until additional research or updates to regulations occur.

### 3.4.1.5 Biochar Market

In 2018, a survey of the U.S. biochar industry was conducted in North America. The survey was sent to both biochar producers and consumers (Draper et al., 2018). Out of an estimated 135 U.S. biochar producers, 61 producers (18 percent resellers) responded. These producers reported that their primary pyrolysis feedstock was woody biomass but could also include other organic materials such as manure, grass, agricultural waste, construction waste, fiber, and food waste. Data from the survey suggested that the annual production of biochar in the U.S. was 35,000 to 70,000 tons. End-uses for biochar were primarily in agricultural application, draining, cannabis production, and odor control. This is consistent with biochar potential uses in compost, soil amendment, gardening, livestock bedding, and land and water reclamation projects (Draper et al., 2018). The average price from all producers was \$129 per cubic yard or approximately \$763 per ton assuming a bulk density of 338 pounds per cubic yard.

The largest expected market growth for biochar is for crop application and then for use for water purification and filtration (Draper et al., 2018). In the Pacific Northwest region, several producers of biochar currently provide a variety of products.

**Table 4** below summarizes biochar producers and prices in the Pacific Northwest.

**Table 4. Summary of Biochar Producers in the Pacific Northwest**

| Producer                 | State             | Feedstock            | Product                   | Bagged Price (\$/CY) <sup>1</sup> | Bulk Price (\$/CY) <sup>1</sup> | Bulk Price (\$/DT) <sup>2</sup> |
|--------------------------|-------------------|----------------------|---------------------------|-----------------------------------|---------------------------------|---------------------------------|
| Pacific Biochar          | California/Oregon | Forestry Residues    | Blacklite Mix #6          | \$164                             | \$135                           | \$521                           |
| Sonoma Biochar           | California        | Wood waste           | Sonoma Biochar            | \$470                             | \$240                           | \$1420                          |
| Oregon Biochar Solutions | Oregon            | Wood Waste Residues  | Rogue Biochar             | \$150                             | \$110                           | \$799                           |
| Sunriver Biochar         | Oregon            | Wood                 | Sunriver Biochar          | \$500                             | -                               | -                               |
| Biochar Supreme          | Washington        | Forestry Residues    | Black Owl Premium Biochar | \$1054                            | \$350                           | \$2071                          |
| Olympic Biochar          | Washington        | Paper Mill Byproduct | Olympic Biochar           | \$135                             | \$105                           | \$621                           |

<sup>1</sup> Prices reflect November 2019 values from respective websites.

<sup>2</sup> Assumes an average dry bulk density of 338 lbs per cubic yard.

Although biochar has a potentially high value, market studies have suggested that the demand for the product does not currently meet the supply. The high price of biochar is cost prohibited for wider adoption of the product by more general consumers such as conventional agriculture, home garden, lawn care, and commercial nurseries. The high price point of biochar in general agriculture would require unrealistic increases in crop productivity to break even with cost. Biochar is more likely to be used as a small fraction additive to blended products for wider distribution.

The recent growth in biochar suppliers is likely reflective of early adopters who are positioning for potential future demand. This occurrence is typical in emerging markets. However, a search for biochar producers indicated that the market is still in its infancy. Approximately half of the producers documented in a 2015 survey are no longer in business.

Biosolids-based biochar has not been tested in the biochar market and its market acceptance is unknown. Considering that applications for biochar currently are in high value and niche products, biosolids biochar is unlikely to portray similar positive associations when compared to virgin wood-based biochar. Bioforcetech has suggested a price per ton in the range of \$250, which is approximately 15 to 25 percent of the market price for other biochar products. Biosolids biochar may find more success in mixed/blended products compared to pure products.

### 3.4.1.6 Risks and Challenges

Implementation of technologies with high capital requirements, limited applications, and advanced or complex processes presents a challenge of high technical and financial risk. A recent report from Waste Gasification and Pyrolysis Technology Risk Assessment by the environmental-leaning company GAIA estimated that billions have been lost in the development of failed pyrolysis and gasification projects. The report cites \$2 billion lost from just four UK projects (GAIA, 2017). Failure of gasification and pyrolysis systems have largely been associated with restrictive capital costs, technical and system failures, and limitations in the market demand of end products.

Due to the slow traction and implementation of pyrolysis and gasification technologies, significant consolidation of independent and “start-up” companies has occurred over the last decade. This shift has seen larger companies purchasing and absorbing pyrolysis and gasification technologies to bolster their product lines. However, this change in the vendor market indicates that some companies have financial vulnerabilities and the precarious financial nature of startup companies in sustaining long-term operation. The acquisition of smaller pyrolysis and gasification companies by larger conglomerates does allow for a reduction in the risk of investing in new technologies which have the financial backing.



**Table 5** lists gasification and pyrolysis companies that have conducted business ventures in North America in the past decade but have undergone bankruptcy or acquisition.

| <b>Table 5. Pyrolysis and Gasification Company Consolidation and Bankruptcy</b> |   |
|---|---|
| <b>Company</b>  | <b>Status</b>                                       |
| MaxWest Environmental Systems   | Declared Bankruptcy. Acquired by Aries Clean Energy |
| Oneida Seven Generations Corp   | Defunct   |
| Navitus Sustainable Industries  | Defunct   |
| Lehigh Technologies   | Acquired by Michelin                                |
| GE Gasification Division  | Acquired by Air Products                            |
| U.S. Linc Energy Ltd  | Declared Bankruptcy                                 |
| Solena Fuels  | Declared Bankruptcy                                 |
| Lima Energy   | Declared Bankruptcy                                 |
| KiOR (Inaeris Technologies)   | Declared Bankruptcy                                 |
| Plasco Energy Group   | Declared Bankruptcy, Acquired RMB Advisory          |
| RWE (Germany), Uhde,  | Acquired ThyssenKrupp Uhde                          |
| Carbon Resources Recovery GmbH  | Acquired by Klean Industries                        |
| Thermogenicx  | Defunct   |

### 3.4.2 Bioforcetech

Bioforcetech was founded in 2012 and is part of the Presezzi Extrusion Group based in Italy. Their first U.S.-based pyrolysis system came online in June 2017 at the Silicon Valley Clean Water Authority in Redwood, California.

**Figure 6** below shows the biodryer and pyrolysis unit located in Silicon Valley. Bioforcetech has since supplied two biosolids pyrolysis units in Italy and is in the planning phase at the City of Edmonds, Washington for a pyrolysis system that is coupled with solids belt dryers to replace the city's incinerator. Their European partner PYREG GmbH, has 16 operating plants with two biosolids facilities in Europe. Because Bioforcetech is the only company currently using pyrolysis on biosolids alone in the U.S., it was selected as the representative pyrolysis technology for this study.

Their pyrolysis technology is a 24/7 autonomous system that operates at temperatures between 450 to 750°C. The pyrolysis process is coupled with a biodryer that uses biogenic heat to supplement the energy required for drying before pyrolysis. This allows for a low-energy and high-efficiency system that can potentially be energy self-sufficient. For the biodryer to work, it operates at a low capacity and may not be suitable for all projects. Bioforcetech has partnered with Centrisys to offer a higher capacity compact low-temperature belt dryer. For this study, Bioforcetech recommended the use of the belt-dryer with the pyrolysis system.

The pyrolysis process works by first thermal drying the biosolids to greater than 70 percent dry solids through the use of a belt dryer. The dried biosolids are then fed to the pyrolysis unit where natural gas is used to start-up the process to reach the pyrolysis temperatures. The high temperatures volatilize the organic carbon to produce pygas. The pygas is combusted in a separate chamber and used to heat the outer casing of the reactor allowing the process to be self-sustained without natural gas at that point.

Bioforcetech provides a variety of different contracts and funding options to utilities. Bioforcetech's implementation at Silicon Valley Clean Water Authority is currently through a 10-year biosolids management contract where Bioforcetech owns and operates the system. However, Bioforcetech now offers multiple pyrolysis supply contracts where they can operate the system under short and long-term agreements or offer training and startup support to plant staff.



Figure 6. Silicon Valley Clean Water Authority biosolids drying and pyrolysis system

### 3.4.3 Mass and Energy Balance

BC performed a mass and energy balance analysis for biosolids pyrolysis to evaluate vendor-supplied performance data and develop expected operating criteria for input into BC's SWEET model for estimating overall system energy and greenhouse gas profiles. At the time of this report, there is limited data published related to mass and energy yield assessments for biosolids pyrolysis. Two mass and energy studies performed laboratory scale pyrolysis reactions with a similar experimental setup and temperature range. The first study conducted by Yuan et al. (2013), operated bench-scale pyrolysis reactions until gas production ceased and did not present the residence time of the reaction. This study presented substantially higher yields of biochar than the second, conducted by McNamara et al. (2016), which performed all pyrolysis experiments for a duration of at least 40 minutes. The reported duration of the second study more closely matches the target retention time of the Bioforcetech system (30 min.) evaluated for this project and the reported biochar mass yield. It is likely that the 2013 experiment performed the pyrolysis experiments at shorter retention times than the Bioforcetech system, thus the 2016 study was used to evaluate the mass and energy yields for this project.

The 2016 study collected mass and energy content data from a digested and dried biosolids pyrolysis feed product generated from the Milorganite production facility in Milwaukee, Wis., and the resulting volatilized and biochar fractions from pyrolysis. The gas from the system was run through an impinger to collect the oil (or tar) fraction and the data for the oil and non-condensable gas is presented separately. A summary of the mass and energy yield data presented as a percentage of the mass and energy content of the feed biosolids

at a range of temperatures is provided below in **Table 6**. The original mass data reported for the pyrolysis products was within 8 percent of the feed mass and was normalized below to project the full mass yield for the SWEET model. The difference in the sum of the energy yield percentage data for the products from 100 percent represents the enthalpy of the reaction. If the sum of the energy yields is less than 100 percent, that means that the process was exothermic and did not require additional heat input to sustain the operation. Where the energy yield content sum is higher, that difference represents the cost of energy for pyrolysis.

| Table 6. Mass and Energy Yield Data |         |        |      |        |        |        |
|-------------------------------------|---------|--------|------|--------|--------|--------|
| Nominal Temp<br>(°C)                | Biochar |        | Oil  |        | Syngas |        |
|                                     | Mass    | Energy | Mass | Energy | Mass   | Energy |
| 300                                 | 71%     | 81%    | 25%  | 8.2%   | 4.1%   | 0.1%   |
| 400                                 | 57%     | 55%    | 37%  | 26%    | 5.3%   | 1.1%   |
| 500                                 | 46%     | 33%    | 46%  | 68%    | 8.3%   | 5.8%   |
| 600                                 | 44%     | 31%    | 46%  | 37%    | 10%    | 10%    |
| 700                                 | 41%     | 30%    | 47%  | 37%    | 12%    | 11%    |
| 800                                 | 39%     | 26%    | 43%  | 55%    | 17%    | 19%    |

Source: Summarized from McNamara et. al. (2016)

An example schematic of the mass and energy yield data is provided below in **Figure 7** to provide a diagram of the experimental setup and products generated from a pyrolysis run at 500 °C.

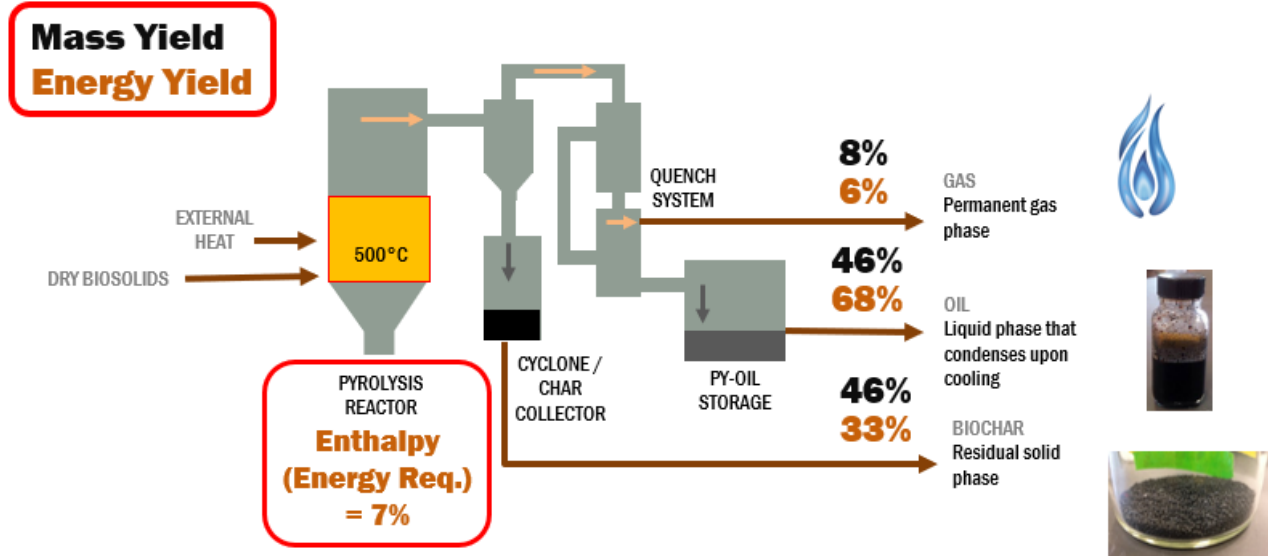
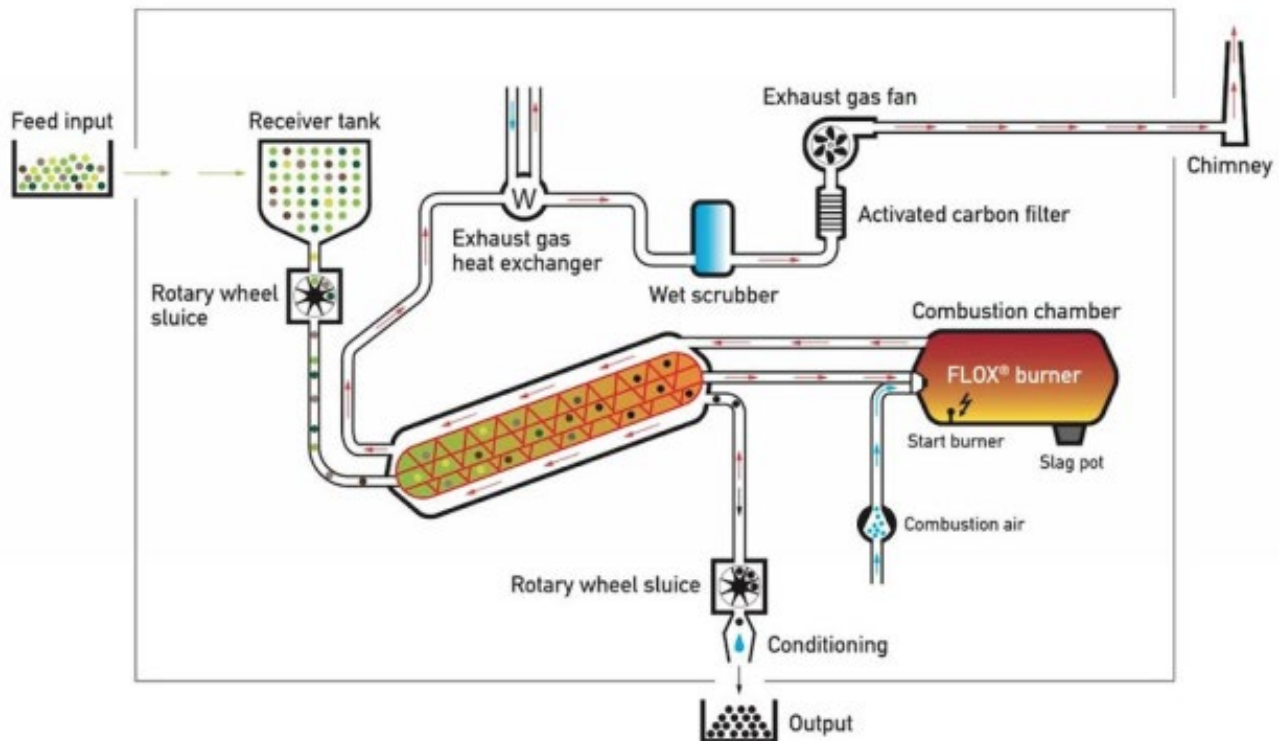

Figure 7. Diagram of mass and energy yield data at 500 °C

The mass and energy yield data summarized from the study by McNamara et. al. was compared to the performance data for the commercial pyrolysis units proposed by Bioforcetech for this project. Bioforcetech supplies two pyrolysis units called the P-Five and P-Three that are operated at a temperature range of 350 °C to 720 °C.

The major difference between the laboratory scale study and the Bioforcetech proposal is that the Bioforcetech system immediately combusts the pyrolysis volatile fraction before condensation can take place, circulates the hot exhaust gas through the pyrolysis reactor jacket to provide thermal energy to the reaction (if required), and then transfers the thermal energy through an air-to-water heat exchanger to potable or filtered process water to supply useful thermal energy in the form of the hot water. Thus the energy yield projected by Bioforcetech represents the useful thermal energy in the form of hot water and accounts for the inefficiencies of heat transfer throughout the process. A process schematic of the Bioforcetech system with exhaust heat recovery is presented below in **Figure 8**.



**Figure 8. Bioforcetech pyrolysis system process schematic**

(Source: Bioforcetech)

A summary of the capacity data for each pyrolysis unit, along with the anticipated mass and energy yield for each system based on the proposal provided by Bioforcetech is provided below in **Table 7**.

| Table 7. Mass and Energy Yield Data Summarized from Bioforcetech Proposal |            |         |        |
|---|------------|---------|--------|
| Parameters  | Source     | P-Three | P-Five |
| Max Throughput (lb-total solids/hour)                                     | Reported   | 264     | 792    |
| Min. Feed (% total solids)  | Reported   | 60%     |        |
| Max Biochar Production (lb/hour)  | Reported   | 106     | 317    |
| Biochar Mass Yield  | Calculated | 40%     |        |
| Max Energy Production (MMBtu/hr)  | Reported   | 0.5     | 1.5    |
| Useful Thermal Energy Yield <sup>1</sup>                                  | Calculated | 27%     |        |

<sup>1</sup> Useful thermal energy recovered in hot water assuming energy content of 7,000 Btu/lb of digested biosolids feed.



The calculated biochar mass yield of 40 percent most closely resembles the 41 percent mass yield observed at 600 °C and is within 5 percent of the mass yield observed at 700 °C in the study summarized above, showing good agreement. At 600 °C, the energy yield of the combined oil and gas fraction was 48 percent in the lab study. When compared to the reported useful thermal energy yield of the Bioforcetech system of 27 percent, this represents a thermal efficiency of 58 percent through the combustion and heat exchangers systems assuming no energy is required by the reactor. This is within a reasonable range assuming each component has a thermal efficiency of 75 percent to 80 percent and also shows good agreement with the lab-scale study.

Based on the results of this analysis, the SWEET model was updated with the lab-scale mass and energy yield parameters for 600 °C. The useful thermal energy generation was calculated based on the thermal efficiency of 58 percent calculated from the Bioforcetech proposal assuming an energy content of 7,000 Btu/lb in the digested biosolids feed. The useful thermal energy was assumed to be at temperatures suitable for heating a belt dryer and was used to offset the natural gas demand required for fueling the hot water dryer heating boiler.

### 3.4.4 Biochar

Limited research exists on the GHG emissions impacts of biochar's application on agriculture and soils. Biochar has been stated to impact emissions by limiting biogenic carbon mineralization by carbon fixation, improving soil health and thereby reducing natural GHG emissions from the soil, and increasing crop productivity.

Pyrolysis converts approximately 10 to 50 percent of the organic carbon biomass into a stable recalcitrant carbon. The recalcitrant carbon is "fixed" and highly stable resisting decomposition over the span of hundreds to thousands of years. Under normal circumstances, natural organic matter decay would have mineralized the carbon into CO<sub>2</sub>. Pyrolysis changes that natural carbon-neutral process into a carbon-negative process. The potential for biochar's use to offset carbon emission was recently accepted by the international panel for climate change (IPCC) as a promising negative emissions technology. The IPCC categories the production and use of biochar under viable options for carbon dioxide removal.

Current literature is inconclusive on the impacts of biochar on soil CO<sub>2</sub>, CH<sub>4</sub>, and N<sub>2</sub>O emissions. This is largely due to the large variety and complexity of soil systems. Primary factors that influence CO<sub>2</sub>, CH<sub>4</sub>, and N<sub>2</sub>O emissions include biochar type, crop selection, crop rotation, temperature, moisture/precipitation, cropping systems, and soil type. Several field studies and meta-analysis studies have found that biochar reduced N<sub>2</sub>O emissions from soil (Cayuela et al., 2015; Cross et al, 2011; Fidel et al., 2018; Liu et al., 2018). Other studies have found an increase in N<sub>2</sub>O emissions or no impact after the first year (Borchard et al., 2019; Wang et al., 2019). The N<sub>2</sub>O emissions reductions were most apparent in paddy and sandy soils (Borchard et al., 2019; Wang et al., 2019). CH<sub>4</sub> emissions were seen to increase when used in paddy fields (Wang et al., 2019; Zhang et al., 2010). In this study, only the fixed carbon sequestration was considered. Given the vast number of variables that can influence biochar's effect on soil GHG emissions, field testing and monitoring of biochar may be required for better estimation of GHG emission reductions. This would allow for site and application-specific impacts of biosolids based biochar.

Data provided by Bioforcetech showed that 28.6 percent of the Silicon Valley Clean Water facility's biochar was comprised of carbon. Biosolids biochar has less carbon content than woody biomass biochar and would reflect less carbon sequestration. Assuming similar conditions for the County's theoretical biochar and that 90 percent of the carbon remained fixed over its lifetime, an emissions factor was calculated to reduce 0.9337 kg of CO<sub>2</sub>e per kg of biochar applied. **Attachment A** provides more details on estimating carbon sequestration value.

A more thorough literature review and field emissions sampling may be required to refine the assessment of biochar's impacts on GHG emissions.

## Section 4: Development of Conceptual Scenarios

The technologies screened and described in the previous sections are building blocks of comprehensive biosolids treatment and use scenarios available to the County. The applicability of the short-listed technologies at each County wastewater treatment plant was dependent on the site-specific constraints, process compatibility, and County preferences. Four scenarios were developed for evaluation in this study from the short-listed technologies and each provides biosolids management for all biosolids produced by KC wastewater treatment plants. It is important to emphasize that the scenarios outlined below are just example of how a combination of appropriate technologies and strategies could be deployed. The examples below do not necessarily represent specific strategies for the named facilities, but rather high-level strategies that could be applied in a variety of combinations. The four scenarios are presented below.

- **Scenario 1: Base-case** - Existing MAD with 100 percent Class B land application to western and eastern Washington
- **Scenario 2: Enhanced Class A** - Existing mesophilic digestion at Brightwater with Class B biosolids hauled to an off-site Class A composting facility and local sales; Cambi at South Plant with Class A land application in western and eastern Washington (40 percent/60 percent); and TAD with batch tanks at West Point and off-site soil blending with local sales
- **Scenario 3: Pyrolysis** - Existing mesophilic digestion at all three plants with dewatered cake hauled to off-site thermal drying and pyrolysis treatment. Biochar byproduct contracted to Bioforcetech under a public-private partnership.
- **Scenario 4: Optimized Class A** - Existing mesophilic digestion at Brightwater with Class B biosolids hauled to an off-site Class A composting facility and local sales; TAD with batch tanks at South Plant with Class A land application in western and eastern Washington (40 percent/60 percent); and TAD with batch tanks at West Point and off-site soil blending with local sales

The development of the first three scenarios was intended to represent a comparison between the existing program, the feasibility of a 100 percent Class A biosolids program, and a pyrolysis program. Scenario 4 was later included to represent an optimized and more cost-effective Class A program than Scenario 2. All off-site facilities were assumed to be located in the South King County area based on details from the *WTD – Class A Basis of Estimate for a Composting Facility* (King County Project No. 1132733).

### 4.1 Flows and Loads

The sizing for each of the scenarios was based on flows and loads that were projected to a 2050 design year. Raw influent flows and loadings for each of the three plants were provided by the County as part of the Flows and Loads Study to evaluate treatment plant capacity limitations. A plant-wide solids mass balance model calibrated during that study was used to calculate digester feed solids loading rates from the 2050 raw influent flows and loadings. **Tables 8 and 9** list the 2050 annual average and 2050 max month loadings, respectively. **Table 10** contains details on the peaking factors. The peaking factors are based on a combination of loading projections provided by the County and historical data at each plant.

| Parameters                      | West Point | South Plant | Brightwater |
|---------------------------------|------------|-------------|-------------|
| Digester feed TS load (lb/d)    | 225,860    | 263,760     | 93,910      |
| Digester feed TVS load (lb/d)   | 182,890    | 226,530     | 84,400      |
| Digester feed %TS               | 6.1        | 6.2         | 5.8         |
| Dewatered solids TS load (lb/d) | 101,170    | 120,810     | 39,450      |



|                      |      |      |      |
|----------------------|------|------|------|
| Dewatered solids %TS | 28.5 | 22.9 | 20.0 |
|----------------------|------|------|------|

| Table 9. 2050 Max Month Flows and Load |            |             |             |
|--|------------|-------------|-------------|
| Parameters                             | West Point | South Plant | Brightwater |
| Digester feed TS load (lb/d)           | 255,760    | 303,520     | 110,640     |
| Digester feed TVS load (lb/d)          | 207,660    | 259,700     | 94,300      |
| Digester feed %TS                      | 6.1        | 6.2         | 5.8         |
| Dewatered solids TS load (lb/d)        | 114,240    | 139,470     | 49,400      |
| Dewatered solids %TS                   | 28.5       | 22.9        | 20.0        |

| Table 10. Digester Peaking Factors      |            |             |             |
|---|------------|-------------|-------------|
| Parameters                              | West Point | South Plant | Brightwater |
| Digester feed max 2-week/max month load | 1.18       | 1.20        | 1.10        |
| Digester feed max week/max month load   | 1.22       | 1.23        | 1.12        |
| Digester feed max day/max month load    | 1.60       | 1.30        | 1.50        |

## 4.2 Scenario 1: Base-case

Scenario 1 was intended to represent maintaining the existing conditions of the County's biosolids management program. Each of the three plants would continue with MAD to produce a Class B biosolids product that would then be trucked to western and eastern Washington for land application. This scenario assumed all solids would be directed to land application to simplify the evaluation even though the current program produces a small amount of Class A compost (less than 1 percent of the Class B biosolids).

Figure 9 is a diagram of Scenario 1. Assumptions on existing digester capacity were taken from the analysis in the King County Treatment Plant Flows and Loadings Study.

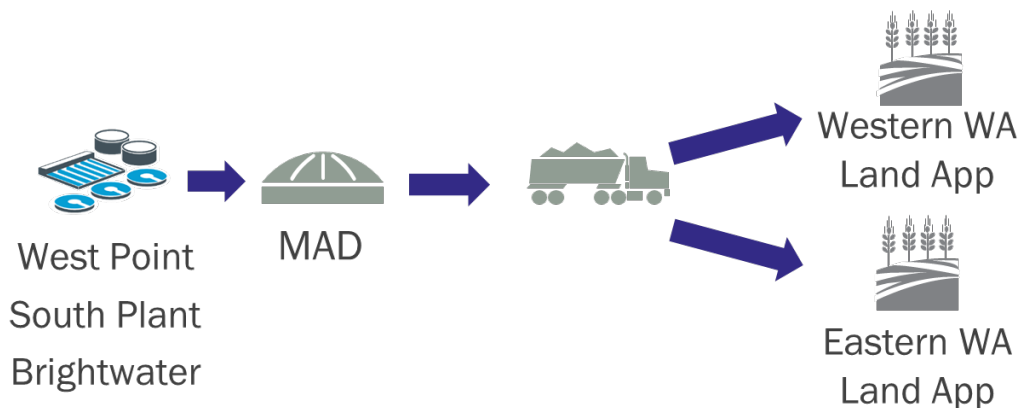

Figure 9. Scenario 1: Base-Case

### 4.2.1 West Point

The 2050 flows and loads projections indicate that West Point would need two additional 2.4 MG mesophilic digesters to meet future capacity requirements based on an organic loading limit of 0.17 lb VS/ft<sup>3</sup>/d. However, West Point currently faces site footprint constraints to accommodate additional digesters. Without



demolition of other existing facilities or locating in spaces allocated for future liquid stream treatment, West Point would need to convert to an intensification technology such as Class B TAD that would increase capacity without requiring additional digester buildout. For the purpose of evaluating the base case Scenario 1 in this study, two additional MAD digesters were used for costing which has a higher cost than the conversion of mesophilic digesters to TAD.

#### 4.2.2 South Plant

The 2050 flows and loads projections indicate that South Plant would need one additional 2.75 MG mesophilic digester to meet capacity requirements based on an organic loading limit of 0.20 lb VS/ft<sup>3</sup>/d. South Plant has available space for four (4) additional digesters and would be able to site the one new digester, but South Plant's footprint availability and constraints are subject to change as other projects may take priority due to regulatory requirements or other plant needs.

#### 4.2.3 Brightwater

The 2050 flows and loads projection indicates that Brightwater would need one additional 1.25 MG mesophilic digester to meet capacity requirements based on an organic loading limit of 0.17 lb VS/ft<sup>3</sup>/d. Brightwater currently has available space for two additional digesters and should be able to site the one new digester.

### 4.3 Scenario 2: Enhanced Class A

Scenario 2 was developed for comparison to other scenarios as a representative mix of Class A processes that could provide a 100 percent Class A biosolids management program for the County. West Point would be converted to a TAD-batch Class A process and would truck their dewatered cake to an off-site soil blending facility. A more detailed alternatives analysis would be needed in the future prior to selection of the final thermophilic technology, TAD or TPAD. The Class A soil blended product would then go to local sales and distribution. South Plant would be converted to a Class A THP-MAD process with land application in western and eastern Washington. Brightwater would continue with Class B MAD process and truck their dewatered cake to an off-site Class A composting facility that would be adjacent to the soil blending facility. The Class A compost products would then go to local sales and distribution. **Figure 10** shows a diagram of Scenario 2.

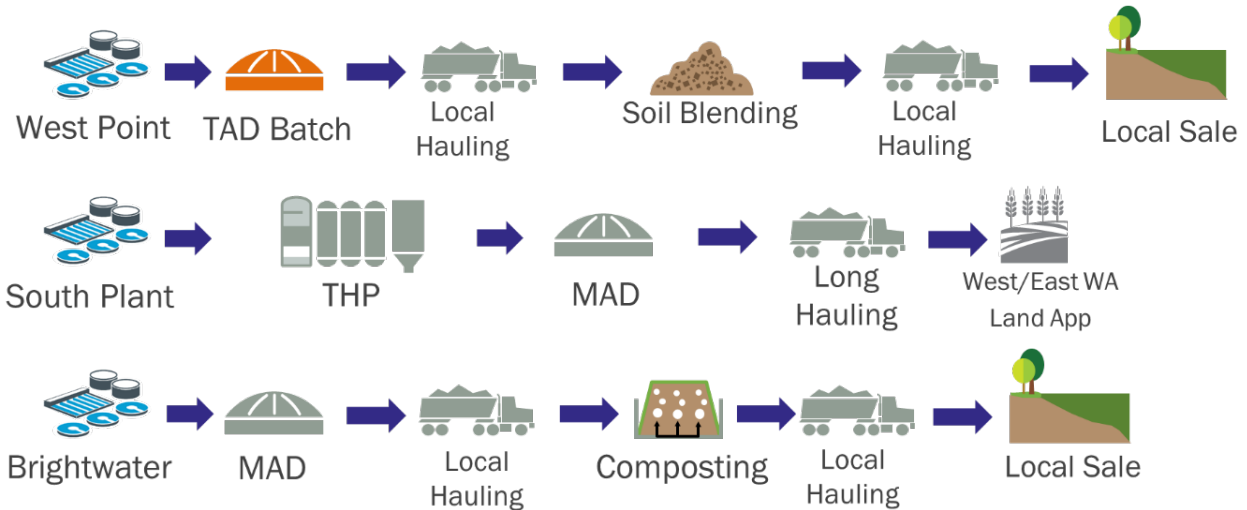

Figure 10. Scenario 2: Enhanced Class A

#### 4.3.1 West Point

Construction of a THP-MAD system at West Point would be challenging if not impossible due to the site limitations which would potentially require the removal of two digesters to fit the ancillary equipment and THP units onsite. Additionally, to construct the new treatment system, temporary trucking of half of West Point's raw wastewater solids to South Plant would be needed for additionally processing throughout a likely three or four-year construction period. Preliminary sizing of a THP-MAD process suggests that its integration at West Point would be challenging and cost prohibited. For the purpose of this study, Therefore, TAD was selected as the Class A digestion process to be implemented at West Point.

TAD can be implemented using different types of configurations with the most common being TAD and TPAD with batch tanks. For this study, TAD with batch tanks (TAD-batch) was selected as the digestion technology.

The application of TAD can increase the organic loading rate on the digesters by more than double current limitations on MAD digesters, freeing up solids digestion capacity. This was reflected in the fact that no new TAD digesters would be required for 2050 flows and loads with an organic loading limit of 0.4 lbs VS/ft<sup>3</sup>/d. The implementation of TAD-Batch would require space for a 1.6 MG rectangular batch tank complex which represents the peak day flow. Conversion from MAD to TAD would require fixing digester covers and mixing, and heating upgrades.

#### 4.3.2 South Plant

The available space at South Plant makes it compatible with THP-MAD. THP-MAD would require pre-dewatering, screening, solids storage hoppers, steam boilers, and four (4) CAMBI THP process trains. No new digesters would be required for a THP-MAD process based on 2050 flows and loads and an organic load limit of 0.4 lbs VS/ft<sup>3</sup>. THP-MAD would require fixed covers, mixing, and heating upgrades.

#### 4.3.3 Brightwater

Under all scenarios, it was assumed Brightwater would stay with MAD and require 1 new digester for 2050 loads. Note that existing Brightwater digesters have fixed covers and they were designed with space allocation for potential future conversion to TAD. Dewatered cake from Brightwater would be trucked to an off-site Class A composting facility for further treatment.

#### 4.3.4 Off-Site Composting Facility

In Scenarios 2 and 4, an off-site Class A composting facility would process the Brightwater dewatered cake. The 2050 flows and load is equal to 35,857 WT/yr, which is approximately 19 percent of the dewatered cake of King County in 2050. The composting process would use aerated static piles. The site would require space for receiving and mixing, composting, curing, screening, and compost and feedstock storage. The site would also include an administration/operation building and space for maintenance staff. The approximate site size is 23 acres and 30 acres with a buffer.

Figure 11 below shows the basic layout for an off-site composting facility.

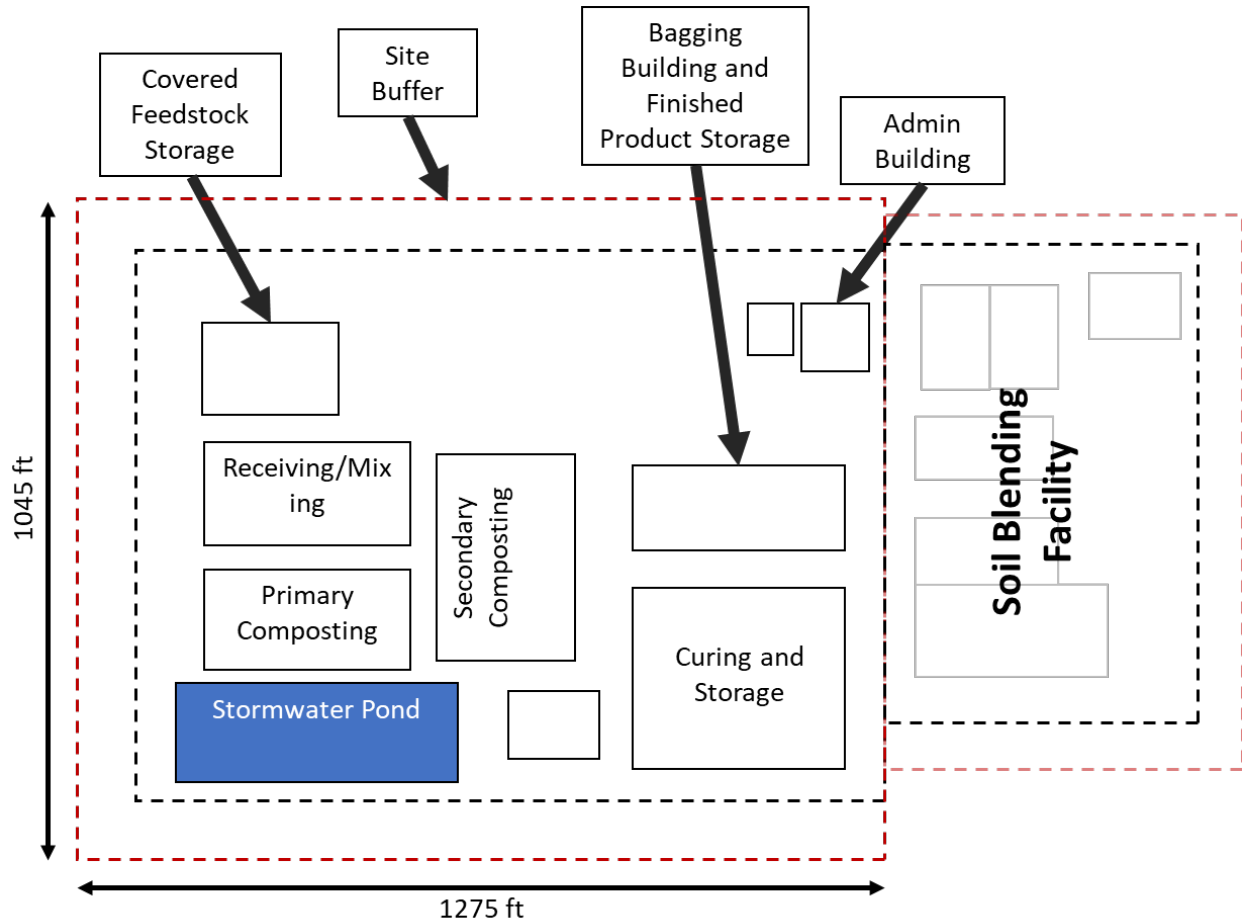

Figure 11. Example layout of an off-site Class A composting facility

#### 4.3.5 Off-Site Soil Blending Facility

An off-site soil blending facility would process West Point's Class A dewatered cake to create a high quality blended biosolids product. The intent of this blended product is to diversify the County's program and potentially generate some revenues from bulk and bagged sale of the product. The soil-blending facility would be designed based on the City of Tacoma's blended product Tagro. This would require mixing biosolids with sand and sawdust at a ratio of 40:40:20 biosolids: sawdust: sand.

The soil blending facility would need space storage space for biosolids cake, sawdust, sand, or other material. Two horizontal auger batch mixers will be used to mix the product.

**Figure 12** below shows the basic components of an off-site soil blending facility. The facility was assumed to be adjacent to the composting facility and would require additional space for the soil-blending processes. The administration and operations building, stormwater, and bagging facility was assumed to be shared with the adjacent composting facility. Additional space will be needed for mixing and storage. The approximate size of the soil blending facility would require an additional 9 acres and 11 acres with additional buffer.

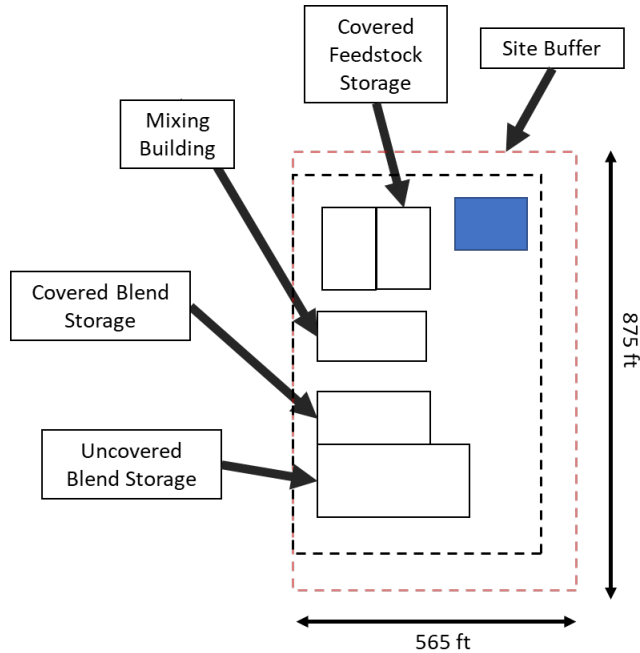

**Figure 12.** Example layout of an off-site soil blending facility

#### 4.4 Scenario 3: Off-Site Pyrolysis

Scenario 3 includes the application of a pyrolysis system for all of King County's biosolids production. West Point, South Plant, and Brightwater would continue with their current Class B processes similar to Scenario 1. The dewatered cake would be transported to the pyrolysis facility to be thermally dried and pyrolyzed into biochar. The end use of biochar would be part of a public-private partnership (P3) in which Bioforcetech would transport the biochar and sell it. Approximately 10 percent of the profit would be returned to the County. **Figure 13** shows a diagram of Scenario 3.

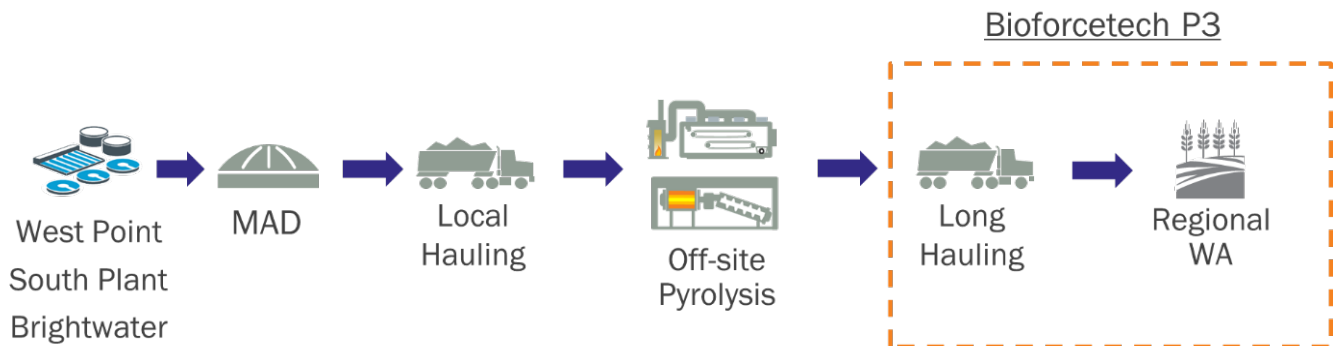

**Figure 13.** Scenario 3: Off-site Pyrolysis

#### 4.4.1 West Point

Refer to **Section 3.2.1** for in-plant changes. Dewatered cake from West Point would be trucked to the off-site pyrolysis facility for further treatment.

#### 4.4.2 South Plant

Refer to **Section 4.2.2** for in-plant changes. Dewatered cake from South Plant would be trucked to the off-site pyrolysis facility for further treatment.

#### 4.4.3 Brightwater

Refer to **Section 4.2.3** for in-plant changes. Dewatered cake from Brightwater would be trucked to the off-site pyrolysis facility for further treatment.

#### 4.4.4 Off-Site Pyrolysis facility

Due to site constraints at West Point, South Plant, and Brightwater, an off-site location would be required for a pyrolysis system. Bioforcetech would be used as the representative technology for pyrolysis due to it being the only technology with a U.S. installation. A belt dryer will be used upstream of the pyrolysis system rather than the Bioforcetech's Biodryer due to its low capacity which would increase cost and space requirements. This design is based on another ongoing design of a Bioforcetech facility located in Edmonds, Washington. To meet the demand 2050 flows and load projections, the site would need 12 DLT 1120 belt dryers and 24 BFT P-THREE pyrolysis units. Ancillary equipment would be needed such as odor control, storage hoppers, conveyors, and boilers. The approximate size of a facility would require 6.2 acres and 12 acres with additional buffer.

**Figure 14** shows the basic footprint of the off-site pyrolysis facility.

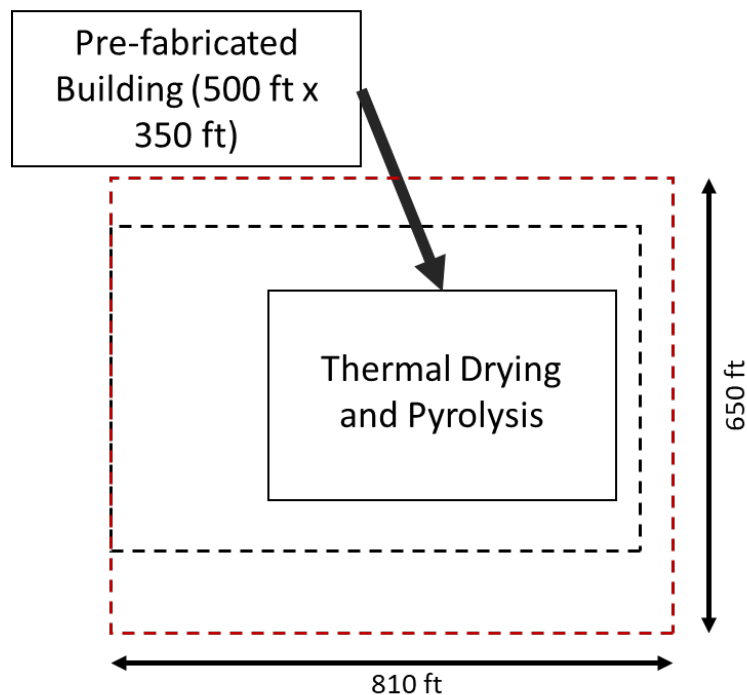

**Figure 14.** Example layout of an off-site pyrolysis facility

## 4.5 Scenario 4: Optimized Class A

Scenario 4 was added due to the high cost of the THP process and to provide an opportunity to compare a different Class A digestion approach. Scenario 4 is identical to Scenario 2 except that South Plant would also be converted to a TAD-Batch Class A digestion process instead of a THP-MAD process. **Figure 15** shows a diagram of Scenario 4.

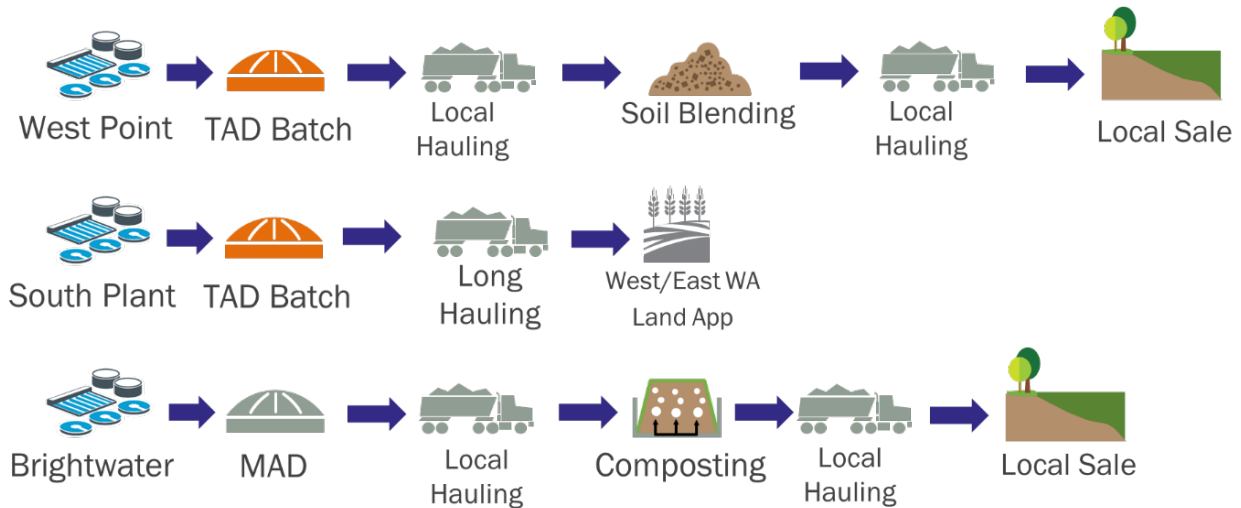

**Figure 15. Scenario 4: Optimized Class A**

Refer to **Section 4.3** above for details on West Point, Brightwater, soil blending, and composting.

## Section 5: Solids, Energy, and Greenhouse Gas Evaluation

With the four scenarios defined, a technical evaluation of the solids, energy, and GHG emissions for each scenario was completed. BC's Solids-Water-Energy-Evaluation Tool (SWEET) was used to evaluate the mass and energy balance and the performance of the scenarios at a high level. SWEET tracks volatile solids, inert solids, and water through potential process alternatives, and considers the energy required to power and heat those processes. This allows for energy production and material recovery to be estimated based on the 2050 flows and loads. A GHG inventory was developed for each scenario-based material consumption, electricity, process fuel, transportation fuel, fugitive emissions, carbon sequestration, and fertilizer offsets.

The following sections describe the results of the evaluations using SWEET.

### 5.1 Mass and Energy Results

Mass and energy outputs for each scenario were developed based on annual average 2050 flows and loads and are summarized in **Table 11**. The solids treatment process performances were based on the design criteria presented in **Attachment A**, while power, chemical, and vehicle fuel consumption were based on historical data. The results of the SWEET model were used to develop the TBL and O&M costs.

Several assumptions were made to complete mass and energy balances. These are summarized in **Attachment A**. The results of the SWEET model can be seen in **Attachment B**.

**Table 11. Summary of Mass and Energy Outputs from the SWEET (2050 Flows and Loads)**

| Parameter                                   | Scenario 1<br>Base-case | Scenario 2<br>Enhanced Class A | Scenario 3<br>Pyrolysis | Scenario 4<br>Optimized Class A |
|---|-------------------------|--------------------------------|-------------------------|---------------------------------|
| Final Product, Wet (WT/d)                   | 539                     | 689                            | 63                      | 744                             |
| Trucks Required (Trucks/d)                  | 19                      | 67                             | 22                      | 68                              |
| Vehicle Fuel Consumption (gal/day)          | 1952                    | 1360                           | 104                     | 1445                            |
| Electricity Demand (MWh/d)                  | 75                      | 101                            | 203                     | 85                              |
| Electricity Generation (MWh/d) <sup>1</sup> | -42                     | -45                            | -42                     | -45                             |
| Net Power (MWh/d)                           | 33                      | 56                             | 160                     | 40                              |
| Natural Gas Consumption (scfm)              | 145                     | 260                            | 708                     | 210                             |
| Digester Gas Produced (scfm)                | 3325                    | 3419                           | 3325                    | 3502                            |
| Methane Injected into Pipeline (scfm)       | 778                     | 787                            | 778                     | 829                             |
| Polymer Use (lb/day)                        | 4611                    | 6359                           | 4611                    | 4344                            |

<sup>1</sup> Electricity generated through co-gen at West Point is sold to Seattle City Light and not used internally.

## 5.2 Greenhouse Gas Emission Results

A GHG emissions inventory was developed for each of the scenarios based on the annual average 2050 flows and loads. GHG inventories for the scenarios were developed based on GHGs emitted during operation of the biosolids treatment facilities, and transportation and end-use of biosolids.

The emission scopes and factors were based on the guidelines published by The Climate Registry (TCR) and Intergovernmental Panel on Climate Change (IPCC) and updated with recent publications. Emissions were divided into three categories representing the system boundaries of direct and indirect emissions of GHG:

- **Scope 1 emissions** are direct emissions from sources owned by the agency (e.g., emissions from fuel combustion by the agency, fugitive emissions from the agency's facilities)
- **Scope 2 emissions** are indirect emissions from sources outside the agency's facility boundaries (e.g., emissions from the production of electricity consumed by the agency)
- **Scope 3 emissions** are all other indirect emissions such as emissions from the manufacturing of materials used by the agency (e.g., polymer used for dewatering)

Emissions were not considered for the construction of the facilities. This is largely due to the fact that lifecycle emissions have been shown to be more significant than those emitted during construction and from construction materials.

The GHG emissions from each scenario are listed in **Table 12** and shown in **Figure 16** below. The negative emissions are shown as carbon credits and come from electricity produced and sold, renewable natural gas production, carbon sequestration and fertilizer offset from land application of biosolids. More detailed information on GHG emissions can be found in **Attachment B**.

**Table 12. Summary of GHG Emissions (2050 Flows and Loads)**Metric Tons of CO<sub>2</sub> Equivalent per Year

| Scope   | Parameter                           | Scenario 1:<br>Base-case | Scenario 2:<br>Enhanced Class A | Scenario 3:<br>Pyrolysis | Scenario 4:<br>Optimized Class A |
|---------|-------------------------------------|--------------------------|---------------------------------|--------------------------|----------------------------------|
| Scope 1 | Fugitive Emissions                  | 9,444                    | 8,489                           | 8,536                    | 8,642                            |
|         | Fuel Combustion (Boilers, Machines) | 4,042                    | 9,452                           | 19,735                   | 8,055                            |



Class A Biosolids Technology Evaluation

|  |                                      |                |                |                |                |
|--|--------------------------------------|----------------|----------------|----------------|----------------|
|  | <b>Scope 1 Total</b>                 | <b>13,486</b>  | <b>17,941</b>  | <b>28,270</b>  | <b>16,697</b>  |
| Scope 2  | Electricity Usage                    | 104            | 112            | 104            | 112            |
|  | Electricity Exported                 | -100           | -107           | -100           | -107           |
|  | <b>Scope 2 Total</b>                 | <b>3.6</b>     | <b>4.4</b>     | <b>3.6</b>     | <b>4.4</b>     |
| Scope 3  | Polymer Consumption                  | 6,885          | 9,949          | 6,885          | 6,942          |
|  | Natural Gas Use                      | 1,068          | 1,915          | 5,213          | 1,546          |
|  | Hauling, Transportation, Application | 8,467          | 4,433          | 924            | 4,803          |
|  | <b>Scope 3 Total</b>                 | <b>16,421</b>  | <b>16,297</b>  | <b>13,023</b>  | <b>13,290</b>  |
| <b>Scope 1-3 Total</b>   |                                      | <b>29910</b>   | <b>34242</b>   | <b>41297</b>   | <b>29992</b>   |
| Credits  | Fertilizer Offset                    | -9,766         | -9,694         | -6,029         | -9,638         |
|  | Carbon Sequestration                 | -52,919        | -47,589        | -19,410        | -47,216        |
|  | Pipeline RNG                         | -31,501        | -31,884        | -31,501        | -33,585        |
|  | <b>Credits Total</b>                 | <b>-94,186</b> | <b>-89,167</b> | <b>-56,940</b> | <b>-90,438</b> |
| <b>Total (metric tons CO2e /year)</b>                          |                                      | <b>-64,276</b> | <b>-54,925</b> | <b>-15,643</b> | <b>-60,446</b> |
| <b>Difference from S1 - Base-case (metric tons CO2e /year)</b> |                                      | <b>0</b>       | <b>+9,351</b>  | <b>+48,632</b> | <b>+3,830</b>  |

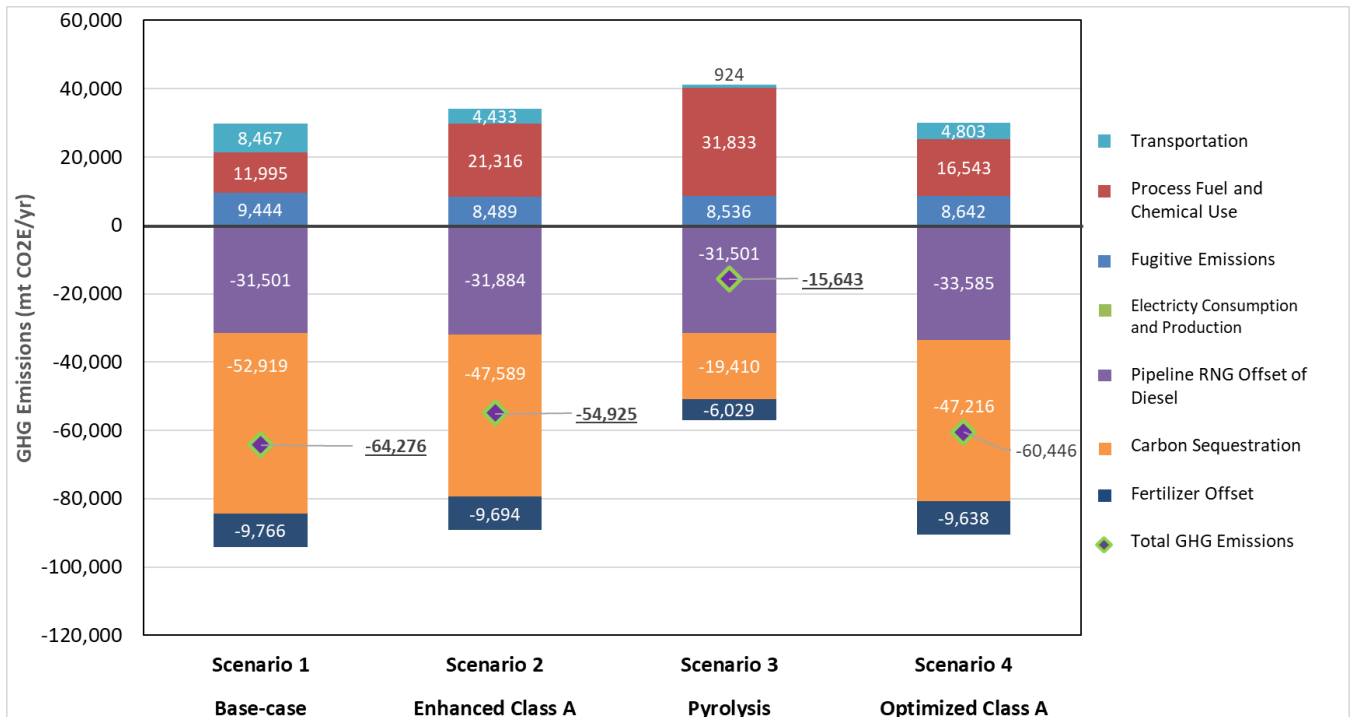

**Figure 16. Summary of GHG emissions**  
(based on 2050 flows and loads)

The results of the GHG inventories showed that Scenario 1: Base-case had the lowest GHG emissions with Scenario 4: Optimized Class A and Scenario 2: Enhanced Class A following closely. Scenario 1: Base-case



also had the lowest sum for Scope 1-3 emissions as shown in **Table 13** below. Scenario 3: Pyrolysis had more significant GHG emissions due to the lower carbon sequestration and increase in emissions from process fuel usage. An analysis of biochar's carbon sequestration potential is included in **Section 3.5.8**.

## Section 6: Cost Assessment

A simplified 20-year net present value (NPV) was developed for each of the scenarios to account for both the total escalated project capital cost and the operation and maintenance (O&M) costs. The NPV are intended to be used only as comparative costs between alternatives. Salvage and replacement cost were not included. Total project capital cost (TPCC) were escalated to 2028 and discounted back to 2020. The O&M assumed operation from 2030 to 2050 and was escalated based on solids growth projections and then discounted back to 2020 for an NPV. For both capital and O&M costs, the calculations were performed using an escalation rate of 3 percent and a discount rate of 5.25 percent. Escalated TPCCs were provided in **Table 13** below and represent the true TPCC of the project. **The escalated TPCC is a better reflection of the costs that may impact budget, sewer rates, and other planning impacts.** However, future evaluations with more detailed costing will be needed to provide the classification accuracy ranges needed to understand impacts to the program. The sections below discuss these concepts in further detail.

**Figure 17** below summarizes the general approach.

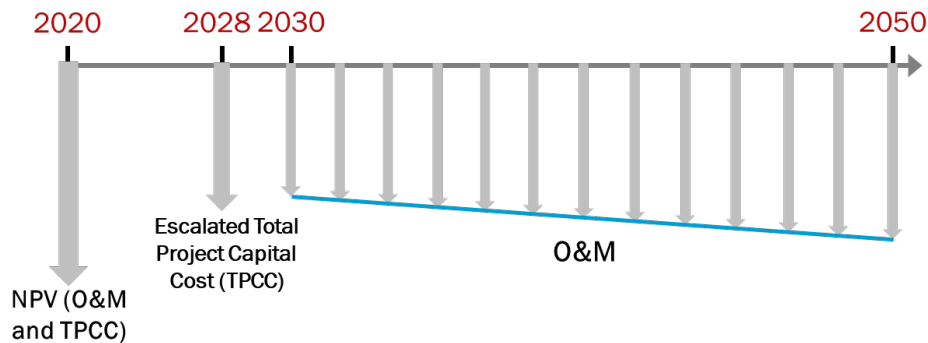

**Figure 17. Diagram of cash flow**

### 6.1 Total Project Capital Costs

Estimated construction costs were developed based on pre-Class 5 AACE International standards for each scenario. These costs were input into the County's cost models to develop TPCC. To reflect the present value of capital cost, project capital cost was escalated to an assumed midpoint of construction of 2028 and then discounted back to 2020. **Table 13** provides a summary of the estimated construction, project capital cost, and escalated and discounted project capital cost. More detailed information on the project capital costs can be found in **Attachment C**.

| Scenarios | Facility    | Estimated Construction | Total Project Capital Cost | Total Project Capital Cost (Escalated to midpoint 2028) | Total Project Capital Cost (Escalated and Discounted) |
|-----------|-------------|------------------------|----------------------------|---|---|
| S1        | West Point  | \$76                   | \$142                      | \$180   | \$119   |
|           | South Plant | \$44                   | \$83                       | \$105   | \$70  |
|           | Brightwater | \$20                   | \$39                       | \$50  | \$33  |

## Class A Biosolids Technology Evaluation

|    | <b>Total</b>  | <b>\$139</b> | <b>\$264</b> | <b>\$335</b>   | <b>\$222</b> |
|----|---------------|--------------|--------------|----------------|--------------|
| S2 | West Point    | \$69         | \$129        | \$163          | \$108        |
|    | Soil Blending | \$32         | \$58         | \$74           | \$49         |
|    | South Plant   | \$292        | \$520        | \$659          | \$438        |
|    | Brightwater   | \$20         | \$39         | \$50           | \$33         |
|    | Composting    | \$68         | \$120        | \$152          | \$101        |
|    | <b>Total</b>  | <b>\$481</b> | <b>\$867</b> | <b>\$1,098</b> | <b>\$729</b> |
| S3 | West Point    | \$76         | \$142        | \$180          | \$119        |
|    | South Plant   | \$44         | \$83         | \$105          | \$70         |
|    | Brightwater   | \$20         | \$39         | \$50           | \$33         |
|    | Pyrolysis     | \$371        | \$617        | \$782          | \$519        |
|    | <b>Total</b>  | <b>\$510</b> | <b>\$881</b> | <b>\$1,117</b> | <b>\$741</b> |
| S4 | West Point    | \$69         | \$129        | \$163          | \$108        |
|    | Soil Blending | \$32         | \$58         | \$74           | \$49         |
|    | South Plant   | \$61         | \$115        | \$146          | \$97         |
|    | Brightwater   | \$20         | \$39         | \$50           | \$33         |
|    | Composting    | \$68         | \$120        | \$152          | \$101        |
|    | <b>Total</b>  | <b>\$250</b> | <b>\$462</b> | <b>\$585</b>   | <b>\$388</b> |

## 6.2 Operation and Maintenance Costs

O&M costs were considered over a 20-year period and presented as a net present value. O&M costs were associated only with solids treatment including processing, handling and end-use. These costs considered labor, maintenance and parts replacement, material use, energy consumption, and end-use. Revenues from biosolids product sales, electricity and renewable natural gas were also included. Revenues from the biosolids product sales assumed a stepwise increase. Refer to **Attachment C** for more details. The O&M costs related to labor and parts replacement were built from data provided by the County. O&M costs were escalated based on the discount rate as well as a linear projection of biosolids increase from 2018 to 2050.

**Table 14** and **Figure 18** provides details on the biosolids growth projections used for this analysis. **Attachment C** provides more detailed on O&M costs.

| Parameter                   | West Point | South Plant | Brightwater | Total  |
|-----------------------------|------------|-------------|-------------|--------|
| 2018 Dewatered Cake (WT/yr) | 49258      | 64332       | 15948       | 129537 |
| 2050 Dewatered Cake (WT/yr) | 64784      | 96279       | 35998       | 197061 |
| 2050 Percent of Total       | 32.9%      | 48.9%       | 18.3%       | -      |
| Years                       | 32         | 32          | 32          | 32     |
| Percent Change              | 31.5%      | 49.7%       | 125.7%      | 52.1%  |
| Slope                       | 1.0%       | 1.6%        | 3.9%        | 1.6%   |

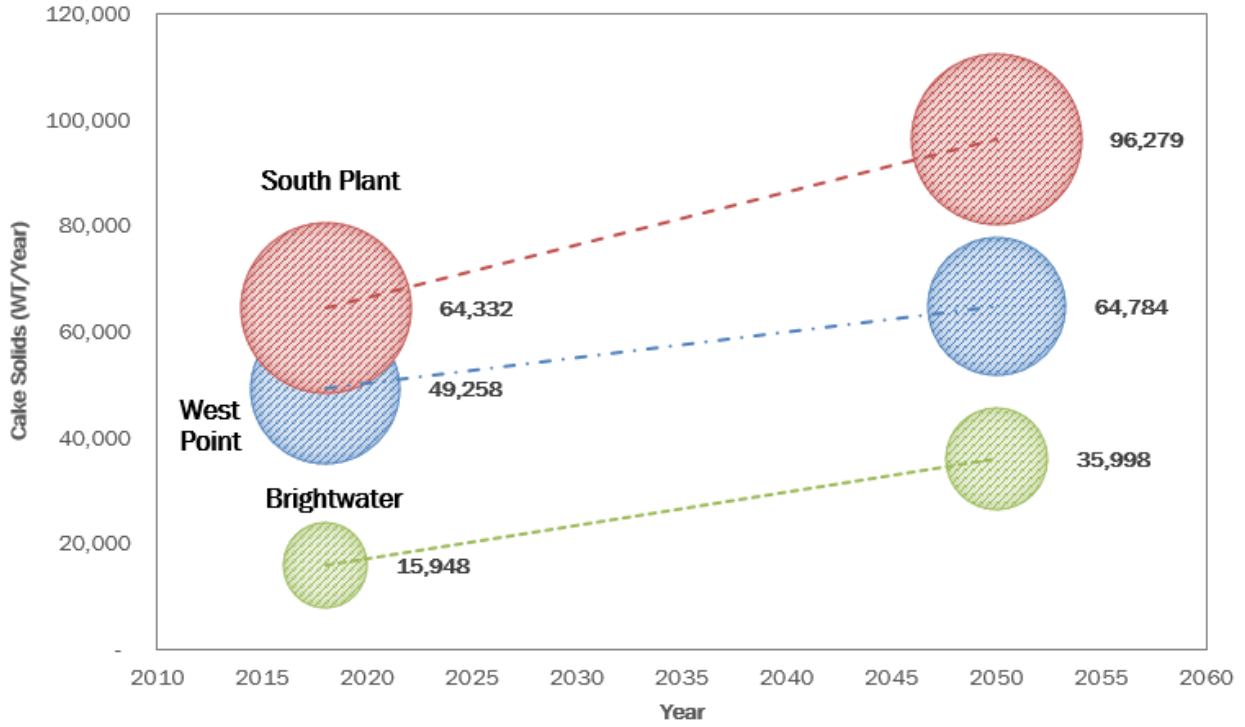

Figure 18. Diagram of solids growth projections

Table 15 provides a summary of NPV O&M for each scenario.

| Table 15. Summary of Net Present Value O&M and Revenues<br>(in 2020 \$ millions) |               |              |                |              |
|--|---------------|--------------|----------------|--------------|
| Scenarios  | Facility      | O&M          | Revenues       | Total        |
| S1   | West Point    | \$171        | (\$20)         | \$151        |
|  | South Plant   | \$220        | (\$100)        | \$120        |
|  | Brightwater   | \$72         | (\$1)          | \$71         |
|  | <b>Total</b>  | <b>\$463</b> | <b>(\$122)</b> | <b>\$342</b> |
| S2   | West Point    | \$123        | (\$20)         | \$103        |
|  | Soil Blending | \$97         | (\$29)         | \$68         |
|  | South Plant   | \$262        | (\$102)        | \$160        |
|  | Brightwater   | \$48         | \$0            | \$48         |
|  | Composting    | \$73         | (\$34)         | \$39         |
|  | <b>Total</b>  | <b>\$602</b> | <b>(\$184)</b> | <b>\$418</b> |
| S3   | West Point    | \$122        | (\$19)         | \$104        |
|  | South Plant   | \$149        | (\$98)         | \$51         |
|  | Brightwater   | \$48         | \$0            | \$48         |
|  | Pyrolysis     | \$132        | (\$4)          | \$127        |
|  | <b>Total</b>  | <b>\$451</b> | <b>(\$121)</b> | <b>\$330</b> |
| S4   | West Point    | \$123        | (\$20)         | \$103        |



|               |              |                |              |
|---------------|--------------|----------------|--------------|
| Soil Blending | \$97         | (\$29)         | \$68         |
| South Plant   | \$194        | (\$108)        | \$86         |
| Brightwater   | \$48         | \$0            | \$48         |
| Composting    | \$73         | (\$34)         | \$39         |
| <b>Total</b>  | <b>\$534</b> | <b>(\$191)</b> | <b>\$344</b> |

**Table 16** provides a summary of annual O&M and revenues presented in 2050 dollars, which reflects the fully operational scenarios and full maturity of the biosolids market/revenues.

| <b>Table 16. Summary of 2050 Annual O&amp;M and Revenues<br/>(in \$ millions)</b> |                 |                |                 |               |
|---|-----------------|----------------|-----------------|---------------|
| <b>Scenarios</b>  | <b>Facility</b> | <b>O&amp;M</b> | <b>Revenues</b> | <b>Total</b>  |
| S1  | West Point      | \$14.3         | (\$1.7)         | \$12.6        |
|   | South Plant     | \$19.0         | (\$8.7)         | \$10.3        |
|   | Brightwater     | \$6.8          | (\$0.1)         | \$6.7         |
|   | <b>Total</b>    | <b>\$40.1</b>  | <b>(\$10.4)</b> | <b>\$29.6</b> |
| S2  | West Point      | \$10.3         | (\$1.7)         | \$8.6         |
|   | Soil Blending   | \$8.1          | (\$3.7)         | \$4.4         |
|   | South Plant     | \$22.7         | (\$8.8)         | \$13.8        |
|   | Brightwater     | \$4.5          | \$0.0           | \$4.5         |
|   | Composting      | \$6.8          | (\$4.3)         | \$2.5         |
|   | <b>Total</b>    | <b>\$52.3</b>  | <b>(\$18.5)</b> | <b>\$33.8</b> |
| S3  | West Point      | \$10.2         | (\$1.6)         | \$8.7         |
|   | South Plant     | \$12.9         | (\$8.4)         | \$4.4         |
|   | Brightwater     | \$4.5          | \$0.0           | \$4.5         |
|   | Pyrolysis       | \$11.4         | (\$0.6)         | \$10.9        |
|   | <b>Total</b>    | <b>\$39.0</b>  | <b>(\$10.6)</b> | <b>\$28.4</b> |
| S4  | West Point      | \$10.3         | (\$1.7)         | \$8.6         |
|   | Soil Blending   | \$8.1          | (\$3.7)         | \$4.4         |
|   | South Plant     | \$18.9         | (\$9.4)         | \$9.6         |
|   | Brightwater     | \$4.5          | \$0.0           | \$4.5         |
|   | Composting      | \$6.8          | (\$4.3)         | \$2.5         |
|   | <b>Total</b>    | <b>\$48.6</b>  | <b>(\$19.0)</b> | <b>\$29.6</b> |

## Section 7: Triple Bottom Line

A triple bottom line (TBL) was adapted from the *KC Biosolids Program Strategic Plan 2018-2037* and modified to fit the needs of this study. Four criteria categories were developed: social, environmental, economic, and technical. A detailed description of each of the criteria and more details on the TBL and rationale for rating each criterion and scenario can be found in **Attachment D**.

Each criterion received a raw score between 0 to 5 points. The calculation of the total weighted score can be described by the formula below.

$$Total\ Weighted\ Score = \sum \left( Weighting \times \frac{Raw\ Score}{Max\ Possible\ Score} \right)$$

High total weighted scores represent the best scenarios.

## 7.1 Social and Equity Criteria Category

The social and equity criteria category considered how each scenario could increase or decrease the quality of life of King County residents, taking into account the differing baselines for the communities around South, West Point, and Brightwater Treatment Plants. These criteria were adapted from the County's *The Determinants of Equity Report*. **Table 17** summarizes the scores of the social and equity criteria category.

| Criterion                                     | Weighting factor | Scenario 1 Base-case | Scenario 2 Enhanced Class A | Scenario 3 Pyrolysis | Scenario 4 Optimized Class A |
|---|------------------|----------------------|-----------------------------|----------------------|------------------------------|
| <b>Built and Natural Environment</b>          |                  |                      |                             |                      |                              |
| E1. Noise                                     | 2                | 5                    | 2                           | 3                    | 2                            |
| E2. Odors                                     | 3                | 4                    | 2                           | 2                    | 2                            |
| E3. Traffic                                   | 2                | 4                    | 2                           | 3                    | 2                            |
| E4. Economic Development/Jobs                 | 5                | 3                    | 4                           | 3                    | 4                            |
| E5. Food Systems                              | 3                | 3                    | 4                           | 2                    | 4                            |
| <b>Total score (out of 15 point possible)</b> |                  | <b>11</b>            | <b>9</b>                    | <b>8</b>             | <b>9</b>                     |

## 7.2 Environmental Criteria Category

King County is dedicated to environmental stewardship and has adopted several initiatives to tackle climate change. As part of the *2015 Strategic Climate Action Plan*, the County has committed to meeting countywide GHG emissions reduction targets of 50 percent by 2030 and 80 percent by 2050. Additionally, the KC Wastewater Treatment Department has set a target goal of carbon-neutral operations by 2025. The environmental criteria category takes into consideration these goals and other environmental criteria. **Table 18** summarizes the scores of the environmental criteria category.

| Criterion                    | Weighting factor | Scenario 1 Base-case | Scenario 2 Enhanced Class A | Scenario 3 Pyrolysis | Scenario 4 Optimized Class A |
|------------------------------|------------------|----------------------|-----------------------------|----------------------|------------------------------|
| <b>Sustainability</b>        |                  |                      |                             |                      |                              |
| C1. Greenhouse Gas Emissions | 10               | 5                    | 4                           | 1                    | 5                            |
| C2. Energy Production/Usage  | 5                | 5                    | 3                           | 2                    | 4                            |
| C3. Fossil Fuel Usage        | 5                | 5                    | 4                           | 2                    | 5                            |

|   |   |           |           |           |           |
|---|---|-----------|-----------|-----------|-----------|
| C4. 100% Beneficial Reuse Regulatory Compliance | 5 | 3         | 5         | 2         | 5         |
| C5. Flexibility to Meet Future Regulations      | 5 | 2         | 4         | 5         | 3         |
| <b>Total score (out of 30 point possible)</b>   |   | <b>25</b> | <b>24</b> | <b>13</b> | <b>27</b> |

### 7.3 Economic Criteria Category

The economic criteria category considers the capital cost and lifecycle cost of the operation and maintenance of the scenarios. This category also evaluates the long-term sustainability of the biosolids management program in terms of diversification of outlets for biosolids application and risks associated with the single option program. **Table 19** summarizes the scores of the economic criteria category.

| Criterion                                     | Weighting factor | Scenario 1 Base-case | Scenario 2 Enhanced Class A | Scenario 3 Pyrolysis | Scenario 4 Optimized Class A |
|---|------------------|----------------------|-----------------------------|----------------------|------------------------------|
| E1. Net Present Value                         | 10               | 4                    | 2                           | 2                    | 3                            |
| E2. Total Project Capital Cost                | 5                | 5                    | 1                           | 1                    | 3                            |
| E3. Market Diversification/Risk               | 10               | 2                    | 5                           | 2                    | 5                            |
| <b>Total score (out of 25 point possible)</b> |                  | <b>17</b>            | <b>15</b>                   | <b>9</b>             | <b>19</b>                    |

### 7.4 Technical Criteria Category

Different technologies offer varying levels of operation, footprints, permitting requirements, and improvements to existing processes. This category considers the technical components of each scenario. **Table 20** summarizes the scores of the technical criteria category.

| Criterion  | Weighting factor | Scenario 1 Base-case | Scenario 2 Enhanced Class A | Scenario 3 Pyrolysis | Scenario 4 Optimized Class A |
|--|------------------|----------------------|-----------------------------|----------------------|------------------------------|
| T1. Process Reliability                              | 10               | 5                    | 4                           | 2                    | 5                            |
| T2. Constructability/Footprint                       | 3                | 3                    | 4                           | 3                    | 5                            |
| T3. Site Permitting                                  | 2                | 5                    | 3                           | 2                    | 3                            |
| T4. Addressing Solids Handling Capacity              | 5                | 3                    | 5                           | 3                    | 5                            |
| T5. Compatibility with Capital and Planning Projects | 5                | 4                    | 2                           | 3                    | 3                            |
| T6. Operational Complexity                           | 5                | 5                    | 2                           | 3                    | 4                            |
| <b>Total score (out of 30 point possible)</b>        |                  | <b>26</b>            | <b>21</b>                   | <b>16</b>            | <b>26</b>                    |

### 7.5 TBL Score Summary

The scores for the four criteria categories were combined for the total scores for each scenario. **Table 21** below provides a summary of those scores.



**Table 21. Summary of Total TBL Scores**

| Criteria Category                               | Category Weights | Scenario 1 Base-case | Scenario 2 Enhanced Class A | Scenario 3 Pyrolysis | Scenario 4 Optimized Class A |
|---|------------------|----------------------|-----------------------------|----------------------|------------------------------|
| Social and Equity                               | 15               | 11                   | 9                           | 8                    | 9                            |
| Environmental                                   | 30               | 25                   | 24                          | 13                   | 27                           |
| Economic  | 25               | 17                   | 15                          | 9                    | 19                           |
| Technical                                       | 30               | 26                   | 21                          | 16                   | 26                           |
| <b>Total score (out of 100 points possible)</b> |                  | <b>79</b>            | <b>69</b>                   | <b>46</b>            | <b>81</b>                    |

The results of the TBL evaluation indicated that Scenario 4: Optimized Class A scored the highest with Scenario 1: Base-case close in score (less than 10 percent difference). Scenario 3: Pyrolysis scored significantly lower for the total score and scored worse in each individual criteria category compared to the other scenarios.

## Section 8: Conclusions

The results of the study indicated that Scenario 4: Optimized Class A was the best scenario overall with Scenario 1: Base-case coming close in the TBL analysis. Scenario 4: Optimized Class A had similar scoring in most criteria but had slightly better ratings in the environmental, economic and technical categories. This is largely due to the reduced risk of the program through diversification and the ability to meet future capacity and regulatory concerns. Scenario 2: Enhanced Class A did not score as well due to the complexity and increase processes that were required to get to a Class A program. The cost of the program was also significantly higher compared to Scenario 4: Optimized Class A. Scenario 3: Pyrolysis scored poorly in every category compared to all three other scenarios due to the technical risks, costs, and uncertainty of the biochar market.

Scenario 1: Base-case had the lowest NPV and total project capital cost overall. It also had the best GHG footprint but Scenario 4: Optimized Class A was within 6 percent. However, Scenario 1: Base-case did not score favorably in several criteria due to risks associated with a Class B single market exposure. Scenario 1: Base-case represents the current biosolids management program used by the County which sends more than 70 percent of the biosolids produced to eastern Washington for Class B land application. This program, as reflected in the scoring of the TBL, has significant risks due to the limited diversification of end-uses for the biosolids. Expanding a Class B program into more markets faces significant regulatory, economic and market barriers. Trends in the Class B biosolids market indicate it will only become more difficult in the future. The failure of their only end-use market could result in having to landfill at high cost, currently estimated around \$3 million dollars per month, which could result in regulatory fines and would also result in significant GHG emissions until further beneficial markets could be established.

Scenario 2: Enhanced Class A did not score as well as Scenario 1: Base-case or Scenario 4: Optimized Class A due to the higher cost and complexity of the implementation of the thermal hydrolysis system at South Plant. Changing this technology to a TAD-Batch system resulted in more favorable scores due to the lower cost and greater simplicity of the solution.

Scenario 3: Pyrolysis was scored the lowest and had the second-highest lifecycle cost. The ratings for this scenario suffered from the fact that the technology is new and not fully proven, uses more energy than other options due to the need to dry the biosolids, and had high costs. Pyrolysis and gasification have the potential for applications but they may be limited to situations where other more favorable alternatives are not

available. The risk of an undeveloped biochar market also adds to the concern of the potential failure of the biosolids management program.

In this study, the three alternative Scenarios 2, 3, and 4 represent a full conversion to a 100 percent Class A program. An incremental approach or a mixed Class A and Class B program may be more realistic due to reduced costs and the ability to grow investments to match Class A market demand.

This study was intended as a high-level analysis for categories of Class A treatment processes. Once major program directions are established, management approved project(s) would be submitted through the County Wastewater Treatment Division's capital project process where they must compete with other capital projects for prioritization and budget allocation. The capital project process would further optimize and develop the options for each individual plant and potential off-site facilities as required.

## Section 9: Sensitivity Discussion

A sensitivity analysis was not a component of the scope for this work; however, this section presents a discussion on variables that could impact the results of the evaluation.

- Gas utilization strategy impacts both the revenues and GHG impacts of any biosolids management program. Electric utilities in this region have composite power sources that include a large and growing component of low-emissions based electricity generation such as hydro-electric, wind, solar, etc. South Plant currently has a purchasing agreement that adds a premium to their electricity rate for sourcing their power from renewable energy with PSE that is set to elapse by 2025. If this purchasing agreement cannot be renewed, the GHG impact of electricity consumption at South Plant could increase. As utilities increase their portfolio of renewable power generation, the net GHG benefit of cogeneration could also decrease.
- RINs and LCFS credits for sale of biogas at South Plant are the largest source of revenue and GHG benefit for the County. The RIN and LCFS market are variable and revenues could increase or decrease in the future. In addition, decisions on future gas use at all three plants will change the overall net revenues and benefits. However, this decision is largely independent of Class A decisions as long as the County remains invested in anaerobic digestion as their principal biosolids treatment option.
- GHG carbon sequestration due to biosolids land application ranges and varies based on various characteristics of the soil system to which the biosolids are applied. Values from King County were used and assumed to represent the biosolids applications in this study.
- Biochar carbon sequestration values were based on the assumption that the biochar carbon content was 28.6 percent and that 90 percent of this carbon remained fixed and would not convert to CO<sub>2</sub>. No other benefits such as reduced soil emissions were considered.
- The assumption for tipping fees for woodchips and sawdust may impact the overall economic evaluation for composting and soil blending, and this market is variable. The City of Tacoma currently purchases sawdust for soil blending to prevent contamination and to maintain Class A designation. The County may also need to purchase sawdust for soil blending to also prevent contamination. A tipping fee could be used for wood waste from tree disposal and other less controlled sources since composting would allow for the time and temperature requirements for Class A.
- Land application rate and revenues from biosolids products can vary due to variables such as public perception/media, weather, agricultural tariffs, and a change of regulations. This study assumed that application rates and revenues follow typical values.
- Capital costs, the timing of capital investments, and the blend of Class A and Class B options will impact the overall costs and TBL scores.

## References

- Borchard N, Schirrmann M, Cayuela ML, Kammann C, Wrage-Mönnig N, Estavillo JM, Fuertes-Mendizábal T, Sigua G, Spokas K, Ippolito JA, Novak J. “Biochar, soil and land-use interactions that reduce nitrate leaching and N<sub>2</sub>O emissions: a meta-analysis”. *Science of the Total Environment*. 2019;651:2354–2364. doi: 10.1016/j.scitotenv.2018.10.060.
- Cayuela, M. L., Jeffery, S., and van Zwieten, L.: “The molar H:C<sub>org</sub> ratio of biochar is a key factor in mitigating N<sub>2</sub>O emissions from soil”. *Agr. Ecosyst. Environ.*, 202, 135–138, doi:10.1016/j.agee.2014.12.015, 2015.
- Fidel, Rivka & Laird, David & Parkin, Timothy. “Effect of Biochar on Soil Greenhouse Gas Emissions at the Laboratory and Field Scales”. *Soil Systems*. 3. 8. 10.3390/soilsystems3010008. 2019.
- Groot, H., Pepke, Ed., Fernholz, K., Henderson, C., Howe, J. “Survey and Analysis of the US Biochar Industry”. Dovetail Partners, Inc. WERC project MN17-DG-230. 2018
- IRENA. “Biofuels for aviation: Technology brief, International Renewable Energy Agency, Abu Dhabi”. 2017.
- Kimbell, L., Kappell, A., McNamara, P. “Effect of pyrolysis on the removal of antibiotic resistance genes and class 1 integrons from municipal biosolids”. *Environmental Science: Water Research & Technology*, 4, 1807-1818. 2018.
- Liu Q, Zhang Y, Liu B, Amonette JE, Lin Z, Liu G, Ambus P, Xie Z. “How does biochar influence soil N cycle? A meta-analysis”. *Plant and Soil*. 2018;426(1–2):211–225. doi: 10.1007/s11104-018-3619-4.
- Ozaki, N., Nakazato, A., Nakashima, K., Kindaichi, T., & Ohashi, A. (2017). Loading and removal of PAHs, fragrance compounds, triclosan and toxicity by composting process from sewage sludge. *The Science of the Total Environment*, 605–606, 860–866. <https://doi.org/10.1016/j.scitotenv.2017.06.165>
- Paz-Ferreiro J, Nieto A, Méndez A, Askeland MPJ, Gascó G. Biochar from Biosolids Pyrolysis: A Review. *Int J Environ Res Public Health*. 2018;15(5):956. Published 2018 May 10. doi:10.3390/ijerph15050956
- Ross J.J., Zitomer, D.H., Miller, T.R., Weirich, C.A., McNamara, P.J. “Emerging investigators series: pyrolysis removes common microconstituents triclocarban, triclosan, and nonylphenol from biosolids”. *Environ. Sci.: Water Res. Technol* (2) 282-289. 2016.
- Semple, K., Reid, B., & Fermor, T. R. (2001). Impact of Composting Strategies on the Treatment of Soils Contaminated with Organic Pollutants. *Environmental Pollution* (Barking, Essex : 1987), 112, 269–283. [https://doi.org/10.1016/S0269-7491\(00\)00099-3](https://doi.org/10.1016/S0269-7491(00)00099-3)
- Techsci Research. “Global Biochar Market By Technology (Pyrolysis, Gasification & Hydrothermal Carbonization), By Application (Farming, Livestock Farming & Others), By Region, Competition, Forecast & Opportunities, 2024”. 2019.
- USBI. 2018. Council of Western State Foresters Biochar Market Analysis – Final Report
- Youngquist, C. P., Mitchell, S. M., & Cogger, C. G. (2016). Fate of Antibiotics and Antibiotic Resistance during Digestion and Composting: A Review. *Journal of Environmental Quality*, 45(2), 537–545. <https://doi.org/10.2134/jeq2015.05.0256>
- Yuan, Haoran & Lu, Tao & Zhao, Dandan & Huang, Hongyu & Kobayashi, Noriyuki & Chen, Yong. “Influence of temperature on product distribution and biochar properties by municipal sludge pyrolysis”. *Journal of Material Cycles and Waste Management*. 15. 10.1007/s10163-013-0126-9. 2013.
- Wang, Y., Villamil, M.B., Davidson, P.C., and Akdeniz, N. “A quantitative understanding of the role of co-composted biochar in plant growth using meta-analysis”. *Science of The Total Environment*, vol. 685, pp. 741-752. 2019.

# **Attachment A: Solids-Water-Energy Evaluation Tool Design Basis and Assumptions**

---



| Operations and Maintenance Assumptions                  |                   |                |                |  |  |
|---|-------------------|----------------|----------------|--|--|
| Cost Element  | Units             | Baseline Value | Value In Model | Notes for Baseline Values  | References   |
| <b>Operation Assumptions</b>                            |                   |                |                |  |  |
| <b>Biogas Utilization</b>                               |                   |                |                |  |  |
| Gas Upgrading Efficiency (1 - % Methane Loss)           | %                 | 90             | 90             |  |  |
| Methane content   | %                 | 60             | 60             |  |  |
| <b>Biogas Utilization</b>                               |                   |                |                |  |  |
| West Point Cogen Usage                                  | %                 | 43.5           | 43.5           |  | KC Value (2017 - present)  |
| West Point Boiler Usage                                 | %                 | 5.9            | 5.9            |  | KC Value (2017 - present)  |
| West Point Raw Sewage Pumps Usage                       | %                 | 8.6            | 8.6            |  | KC Value (2017 - present)  |
| West Point Waste Gas Burner (Flare) Usage               | %                 | 42.0           | 42.0           |  | KC Value (2017 - present)  |
| South Plant Cogen Usage                                 | %                 | 0.0            | 0.0            |  | KC Value (2017 - present)  |
| South Plant Boiler Usage                                | %                 | 0.0            | 0.0            |  | KC Value (2017 - present)  |
| South Plant Gas Upgrading Usage                         | %                 | 84.5           | 84.5           |  | KC Value (2017 - present)  |
| South Plant Waste Gas Burner (Flare) Usage              | %                 | 15.5           | 15.5           |  | KC Value (2017 - present)  |
| Brightwater Boiler Usage                                | %                 | 30.0           | 30.0           |  | KC Value (2017 - present)  |
| Brightwater Waste Gas Burner (Flare) Usage              | %                 | 70.0           | 70.0           |  |  |
| West Point Plant Heat Demand (Building + Process)       | MMBTU/h           | 8.500          | 8.500          | Ranges from 4 to 13 MMBTU/h with peak 17.1(2014)   | 2016 Biogas Op Study   |
| South Plant Heat Demand (Building + Process)            | MMBTU/h           | 12.500         | 12.500         | Ranges from 4 to 13 MMBTU/h with peak 17.6(2014)   | 2016 Biogas Op Study   |
| <b>Composting/Soil Blending</b>                         |                   |                |                |  |  |
| Operational Parameters refer to CMPST and Sblend Sheets |                   |                |                | Operational Parameters refer to CMPST and Sblend Sheets  |  |
| <b>Dewatering</b>                                       |                   |                |                |  |  |
| West Point Centrifuge Polymer Use                       | lb active/DT      | 30             | 30             |  |  |
| South Plant Centrifuge Polymer Use                      | lb active/DT      | 35             | 35             |  |  |
| South Plant Centrifuge THP Predewatering Use            | lb active/DT      | 15             | 15             | Assumed Value  |  |
| South Plant Centrifuge THP Cake Solids                  | %                 | 30             | 30             | Assumed Value  |  |
| Brightwater Centrifuge Polymer Use                      | lb active/DT      | 35             | 35             |  | KC Brightwater Treatment System Technical facts and info sheet               |
| <b>Digestion</b>  |                   |                |                |  |  |
| West Point Mesophilic digestion VSR                     | %                 | 64.01          | 64.01          | Average History Data 01/2012-08/2017   |  |
| South Plant Mesophilic digestion VSR                    | %                 | 60.03          | 60.03          | Digester 1-4 - 56.96, Digester 1-5 - 60.03, Average History Data 07/2014-07/2017   |  |
| Brightwater Mesophilic digestion VSR                    | %                 | 60.94          | 60.94          | Average History Data 01/2013-08/2017   |  |
| THP-MAD VSR   | %                 | 62             | 62             | Assumed slight boost in VSR  |  |
| THP-MAD Gas Production                                  | CF gas/lb VSR-d   | 16.24          | 16.24          | Assumed match of existing SP specific gas production   |  |
| THP-MAD Digester Feed                                   | %                 | 9              | 9              | Assumed from SFPUC   |  |
| TAD-Batch VSR West Point                                | %                 | 68             | 68             | Assumed slight boost in VSR. TAD VSR was similar to MAD. 68 to 74 in coupled thermo-meso (TPAD) pilot. Full-scale Meso 64-78 | 1999 pilot study   |
| TAD-Batch VSR West Point                                | %                 | 64             | 64             | Assumed 4% increase  |  |
| TAD-Batch Gas Production                                | CF gas/lb VSR-d   | 15             | 15             | Assumed match of existing WP specific gas production   |  |
| West Point Mesophilic Gas Production                    | CF gas/lb VSR-d   | 15             | 15             | 01/14-01/15 -> 1.5 MSCF/d  |  |
| South Plant Mesophilic Gas Production                   | CF gas/lb VSR-d   | 16.24          | 16.24          | Average History Data 07/2014-07/2017   |  |
| Brightwater Mesophilic Gas Production                   | CF gas/lb VSR-d   | 16             | 16             |  | BW Technical Facts document  |
| West Point LHV  | Btu/scf           | 555            | 555            | 540-570 calc from 2010-2015  | 2016 Biogas Op Study   |
| South Plant LHV   | Btu/scf           | 550            | 550            | 500-600  | 2013 SP Biogas Utilization Study   |
| Brightwater Plant LHV                                   | Btu/scf           | 550            | 550            | Assumed Similar to WP and SP   |  |
| <b>Pyrolysis</b>  |                   |                |                |  |  |
| Pyrolysis Temperature                                   | °C                | 550            | 550            |  | BFT Biochar Testing Data Sheet   |
| Thermal Drying and Pyrolysis Mass Reduction             | %                 | 87.92          | 87.92          |  | BFT Proposal   |
| Pyrolysis VSR Reduction                                 | %                 | 75.91          | 75.91          | Calculated based on final biochar VS   | BFT Biochar Testing Data Sheet   |
| Biochar VS  | %                 | 33.3           | 33.3           | Assumed 1 - (Ash and N)  | BFT Biochar Testing Data Sheet   |
| Biochar ASH   | %                 | 64.3           | 64.3           |  | BFT Biochar Testing Data Sheet   |
| Biochar N   | %                 | 2.4            | 2.4            |  | BFT Biochar Testing Data Sheet   |
| Biochar C   | %                 | 28.6           | 28.6           |  | BFT Biochar Testing Data Sheet   |
| Biochar P   |                   |                |                |  |  |
| <b>Thermal Hydrolysis (CAMBI)</b>                       |                   |                |                |  |  |
| Steam Requirements                                      | lb Steam/lb DS    | 1.1            | 1.1            | SFPUC and Cambi  |  |
| <b>Cost Assumptions</b>                                 |                   |                |                |  |  |
| <b>Biosolids Hauling and Disposal</b>                   |                   |                |                |  |  |
| Land Application, Cost (Program Average)                | \$/WT             | \$67.42        | \$67           | Net program cost (\$8.7M = \$67.42/wt)   | King County Communication, CurrentProgrambudgetbreakdown.xlsx, December 2019 |
| Land Application, Cost (Western WA, Forestry)           | \$/WT             | \$71.20        | \$71           | Calculated from Program Breakdown (Hauling, fuel, equipment, application, program)   | King County Communication, CurrentProgrambudgetbreakdown.xlsx, December 2019 |
| Land Application, Cost (Eastern WA, Ag)                 | \$/WT             | \$62.70        | \$63           | Calculated from Program Breakdown (Hauling, fuel, equipment, application, program)   | King County Communication, CurrentProgrambudgetbreakdown.xlsx, December 2019 |
| Land Application, Cap Equipment/truck Cost/Yr           | \$/yr             | \$400,000.00   | \$400,000      | Cost for capital expense average including truck purchase average from 2013-2018   | King County Communication, CurrentProgrambudgetbreakdown.xlsx, December 2019 |
| Land Application, Revenue (Western WA, Forestry)        | \$/WT             | \$7.61         | \$7.6          | 204K annual average timber sales (2015-2019)   | King County Communication, CurrentProgrambudgetbreakdown.xlsx, December 2019 |
| Land Application, Revenue (Eastern WA, Ag)              | \$/WT             | \$1.73         | \$1.7          | 178K Revenue from nitrogen value   | King County Communication, CurrentProgrambudgetbreakdown.xlsx, December 2019 |
| <b>Biosolids Revenue Program Start-up Structure</b>     |                   |                |                |  |  |
| Revenue Year 1-2 (Commercial)                           | %                 | 25             | 25             | Compost and Soil Blend Sales   |  |
| Revenue Year 3-8 (Commercial)                           | %                 | 50             | 50             | Compost and Soil Blend Sales   |  |
| Revenue Year 9-14 (Commercial)                          | %                 | 75             | 75             | Compost and Soil Blend Sales   |  |
| Revenue Year 15-20 (Commercial)                         | %                 | 100            | 100            | Compost and Soil Blend Sales   |  |
| Revenue Year 1-2 (Consumer)                             | %                 | 15             | 15             | Compost and Soil Blend Sales   |  |
| Revenue Year 3-8 (Consumer)                             | %                 | 35             | 35             | Compost and Soil Blend Sales   |  |
| Revenue Year 9-14 (Consumer)                            | %                 | 60             | 60             | Compost and Soil Blend Sales   |  |
| Revenue Year 15-20 (Consumer)                           | %                 | 90             | 90             | Compost and Soil Blend Sales   |  |
| <b>Chemical Costs</b>                                   |                   |                |                |  |  |
| Polymer Cost  | \$/lb-Active Poly | 2.00           | 2.00           |  |  |
| <b>Composting</b>                                       |                   |                |                |  |  |
| Hauling Fee (Bulk Material)                             | \$/WT             | \$7.06         | \$7.06         | Contract fee   | King County Communication, CurrentProgrambudgetbreakdown.xlsx, December 2019 |
| Hauling Fee (Fixed local)                               | \$/WT             | \$6.65         | \$6.65         | Contract fee   | King County Communication, CurrentProgrambudgetbreakdown.xlsx, December 2019 |

|  |                 |             |             |  |  |
|--|-----------------|-------------|-------------|--|--|
| Composting Operation Cost                      | \$/wt Biosolids | \$155.98    | \$156       | Adjusted by adding two more operators to KC Estimate. Labor, Maintenance, Program op | King County Communication, CurrentProgrambudgetbreakdown.xlsx, December 2019 |
| Annual Equipment Upgrades                      | \$/yr           | \$80,000.00 | \$80,000    |  |  |
| <b>Compost Revenues</b>                        |                 |             |             |  |  |
| Tippling Fee                                   | \$/WT           | \$20.00     | \$20.00     |  | King County Communication, CurrentProgrambudgetbreakdown.xlsx, December 2019 |
| Bagged Product                                 | \$/CY           | \$67.50     | \$67.50     |  | King County Communication, CurrentProgrambudgetbreakdown.xlsx, December 2019 |
| Bagged Product                                 | \$/2 CF Bag     | \$5.00      | \$5.00      |  | King County Communication, CurrentProgrambudgetbreakdown.xlsx, December 2019 |
| Bulk Retail                                    | \$/CY           | \$25.00     | \$25        |  | King County Communication, CurrentProgrambudgetbreakdown.xlsx, December 2019 |
| Bulk Wholesale                                 | \$/CY           | \$10.00     | \$10        |  | King County Communication, CurrentProgrambudgetbreakdown.xlsx, December 2019 |
| <b>Economics</b>                               |                 |             |             |  |  |
| Escalation Rate                                | %               |             |             |  |  |
| Discount Rate (WTB) (Cost of Capital)          | %               | 5.25        | 5.25        |  | King County Communication, December 2019                                     |
| Discount Rate (OMB)                            | %               | 7           | 7           |  | King County Communication, December 2019                                     |
| WTD Real Discounted Rate                       | %               | 2.18        | 2.18        |  | King County Communication, December 2019                                     |
| Present Worth Comparison                       | years           | 20          | 20          |  |  |
| P:A for 20 years                               |                 |             |             |  |  |
| Annual Growth in Electricity Consumption       | %               | 1           | 1           |  | King County Communication, December 2019                                     |
| <b>Electricity Costs</b>                       |                 |             |             |  |  |
| Electricity Costs (Average)                    | \$/kWh          | \$0.0745    | \$0.0745    |  |  |
| West Point                                     | \$/kWh          | \$0.0781    | \$0.0781    |  | King County Communication, December 2019                                     |
| South Plant                                    | \$/kWh          | \$0.0758    | \$0.0758    |  | King County Communication, December 2019                                     |
| Brightwater                                    | \$/kWh          | \$0.0697    | \$0.0697    |  | King County Communication, December 2019                                     |
| Cogen Electricity Revenues                     | \$/SCF to Cogen | \$0.0056    | \$0.0056    | 2018 - 223M Biogas SCF/yr ~\$1.25M sale -> 0.005593 \$/SCF to Cogen                  | King County Communication, KC BiogasData.xlsx, December 2019                 |
| <b>Fuel Costs</b>                              |                 |             |             |  |  |
| Diesel   | \$/gal          | \$3.60      | \$3.60      | 2019 Average   | EIA Data Wholesale   |
| Propane  | \$/therm        | \$0.86      | \$0.86      | 11/26/2018-11/26/2019  | EIA Data Wholesale   |
| Propane  | \$/gal          | \$0.78      | \$0.78      | 11/26/2018-11/26/2019  | EIA Data Wholesale   |
| Renewable Natural Price (Sold)                 | \$/scf Biogas   | \$0.0196    | \$0.0196    | SP 2017 and 2018 Average   | King County Communication, KC BiogasData.xlsx, December 2019                 |
| Renewable Natural Price (Sold)                 | \$/scf Scrubbed | \$0.0218    | \$0.0218    | SP 2017 and 2018 Average   | King County Communication, KC BiogasData.xlsx, December 2019                 |
| RNG RIN Market Price (Current)                 | \$/MMBtu        | \$23.40     | \$23.40     | 2014-2019 Median Value   |  |
| RNG CA LCFS Market Price (Current)             | \$/MMBtu        | \$6.21      | \$6.21      | 2019 Average Value   |  |
| RIN Premium Allocation                         | %               | 70          | 70          |  |  |
| LCFS Premium Allocation                        | %               | 65          | 65          |  |  |
| NG Market Sale Price (Current)                 | \$/1000 scf     | \$2.70      | \$2.70      |  |  |
| NG Market Purchase Price (Current)             | \$/1000 scf     | \$6.76      | \$6.76      |  | EIA, December 2019   |
| NG Market Purchase Price (Current)             | \$/MMBtu        | \$6.76      | \$6.76      |  | EIA, December 2019   |
| <b>Potable Water</b>                           |                 |             |             |  |  |
| Potable Water                                  | \$/CCF          | 5.98        | 5.98        | 1 CCF = 748 gal  | Seattle Public Utilities Website, December 2019                              |
| <b>Pyrolysis</b>                               |                 |             |             |  |  |
| Hauling Fee (Fixed local)                      | \$/WT           | \$6.65      | \$6.65      |  |  |
| Hauling Fee (Biochar)                          | \$/WT           | \$0.0       | \$0.0       | Bioforcetech's responsibility for hauling, distributing, and selling                 | Bioforcetech Communication, December 2019                                    |
| Biochar Value                                  | \$/WT           | \$250.0     | \$250.0     | Bioforcetech's approximate sale value  | Bioforcetech Communication, December 2019                                    |
| KC Share of Biochar Value                      | %               | 10          | 10          | Bioforcetech share of profit to KC   | Bioforcetech Communication, December 2019                                    |
| Revenue Year 1-2 (P3 Contract)                 | %               | 30          | 30          |  |  |
| Revenue Year 3-8 (P3 Contract)                 | %               | 40          | 40          |  |  |
| Revenue Year 9-14 (P3 Contract)                | %               | 80          | 80          |  |  |
| Revenue Year 15-20 (P3 Contract)               | %               | 100         | 100         |  |  |
| O&M Hours                                      | hrs/yr          | 500         | 500         |  |  |
| Operation and Maintenance                      | \$/WT           | \$15.46     | \$15.46     |  |  |
| Spare parts and Components                     | \$/yr           | \$1,500,000 | \$1,500,000 | \$750,000 for 120,000 WT/yr. Scaled to 200,000 WT/yr                                 |  |
| <b>Soil Blending</b>                           |                 |             |             |  |  |
| Hauling Fee (Bulk Material)                    | \$/WT           | \$7.06      | \$7.06      | Contract fee   | King County Communication, CurrentProgrambudgetbreakdown.xlsx, December 2019 |
| Hauling Fee (Fixed local)                      | \$/WT           | \$6.65      | \$6.65      | Contract fee   | King County Communication, CurrentProgrambudgetbreakdown.xlsx, December 2019 |
| Soil Blending Operation Cost                   | \$/wt Biosolids | \$102.60    | \$102.60    | Labor, Maintenance, Program op. Reduced based on shared cost with Composting         | King County Communication, CurrentProgrambudgetbreakdown.xlsx, December 2020 |
| Sawdust  | \$/WT           | \$14.29     | \$14.29     | Assume high quality sawdust needed that is free of seeds and disease                 |  |
| Fine Sand Cost                                 | \$/WT           | \$8.23      | \$8.23      |  |  |
| <b>Soil Blend Revenues</b>                     |                 |             |             |  |  |
| Tippling Fee                                   | \$/WT           | \$25.00     | \$25.00     |  | King County Communication, CurrentProgrambudgetbreakdown.xlsx, December 2019 |
| Bagged Product                                 | \$/CY           | \$54.00     | \$54.00     |  | King County Communication, CurrentProgrambudgetbreakdown.xlsx, December 2019 |
| Bagged Product                                 | \$/2 CF Bag     | \$4.00      | \$4.00      |  | King County Communication, CurrentProgrambudgetbreakdown.xlsx, December 2019 |
| Bulk Retail                                    | \$/CY           | \$20.00     | \$20        |  | King County Communication, CurrentProgrambudgetbreakdown.xlsx, December 2019 |
| Bulk Wholesale                                 | \$/CY           | \$10.00     | \$10        |  | King County Communication, CurrentProgrambudgetbreakdown.xlsx, December 2019 |
| <b>Treatment Plants</b>                        |                 |             |             |  |  |
| West Point                                     |                 |             |             |  |  |
| Operation and Maintenance                      | \$/wt           | \$128       | \$128       |  | King County Communication, CurrentProgrambudgetbreakdown.xlsx, December 2019 |
| Additional Operation and Maintenance (THP-MAD) | \$/wt           | \$6         | \$6         | Estimated  |  |
| South Plant                                    |                 |             |             |  |  |
| Operation and Maintenance                      | \$/wt           | \$100       | \$100       |  | King County Communication, CurrentProgrambudgetbreakdown.xlsx, December 2019 |
| Additional Operation and Maintenance (THP-MAD) | \$/wt           | \$26        | \$26        | Estimated  |  |
| Brightwater                                    |                 |             |             |  |  |
| Operation and Maintenance                      | \$/WT           | \$102       | \$102       |  | King County Communication, CurrentProgrambudgetbreakdown.xlsx, December 2019 |

| GHG Emissions Assumption                                      |                           |                |                |  |   |  |
|---|---------------------------|----------------|----------------|--|---|--|
| Emissions element   | Units                     | Baseline Value | Value In Model | Notes for Baseline Values  | References  |  |
| <b>Unit Conversions</b>                                       |                           |                |                |  |   |  |
| 1 Btu =   | kWh                       | 0.0002928      | 0.0002928      |  |   |  |
| 1 MMBtu =   | kWh                       | 293            | 293            |  |   |  |
| 1 kg =  | lb                        | 2.205          | 2.205          |  |   |  |
| 1 scf NG =  | MMBtu                     | 0.001          | 0.001          | HHV  |   |  |
| 1 scf Scrubbed Biogas   | MMBtu                     | 0.00099        | 0.00099        |  |   |  |
| 1 gal Gasoline  | MMBtu                     | 0.114          | 0.114          |  |   |  |
| 1 gal Diesel  | MMBtu                     | 0.137381       | 0.137381       |  |   |  |
| 1 GGE   | MMBtu                     | 0.125          | 0.125          |  |   |  |
| 1 gal =   | L                         | 3.785          | 3.785          |  |   |  |
| 1 tonne (MT) =  | kg                        | 1000           | 1000           |  |   |  |
| 1 scf CH4 =   | lb                        | 0.042          | 0.042          |  | Biogas Volume Calculator v2, BEAM, EPA GHG Tool v5                        |  |
| 1 scf Natural Gas (Compressed) =                              | lb                        | 0.0458         | 0.0458         |  |   |  |
| <b>Global Warming Potential</b>                               |                           |                |                |  |   |  |
| CO2   | kg CO2e/kg CO2e           | 1              | 1              |  | IPCC (2014). Climate Change 2014 Synthesis Report Fifth Assessment Report |  |
| CH4   | kg CO2e/kg CH4            | 28             | 28             |  | IPCC (2014). Climate Change 2014 Synthesis Report Fifth Assessment Report |  |
| N2O   | kg CO2e/kg N2O            | 265            | 265            |  | IPCC (2014). Climate Change 2014 Synthesis Report Fifth Assessment Report |  |
| <b>Electricity</b>  |                           |                |                |  |   |  |
| Brightwater Electricity                                       | kg CO2e/MWh               | 8.9            | 8.9            | SnoPUD (80% Hydro, <10% Nuclear, 7% Wind)  | King County Communication, Sep 2019                                       |  |
| South Plant Electricity                                       | kg CO2e/MWh               | 0              | 0              | PSE, KC purchasing 100% renewable  | King County Communication, Sep 2019.                                      |  |
| West Point Electricity  | kg CO2e/MWh               | 6.5            | 6.5            | Seattle City Light (91% Hydro, 4% Nuclear)   | King County Communication, Sep 2019                                       |  |
| <b>Heating</b>  |                           |                |                |  |   |  |
| Coal  | kg CO2e/MMBtu             | 121            | 121            | Includes production emissions  | Biomass Energy Centre (UK)  |  |
| Coal  | kg CO2e/MMBtu             | 104            | 104            | Combustion only (no production)  | 2015 Climate Registry Table 1.2   |  |
| Oil   | kg CO2e/MMBtu             | 92             | 92             | Includes production emissions  | Biomass Energy Centre (UK)  |  |
| Oil No.2  | kg CO2e/MMBtu             | 74             | 74             | Combustion only (no production)  | 2015 Climate Registry Table 1.2   |  |
| Nat Gas   | kg CO2e/MMBtu             | 67             | 67             | Includes production emissions  | Biomass Energy Centre (UK)  |  |
| Nat Gas   | kg CO2e/MMBtu             | 53             | 53             | Combustion only (no production)  | 2015 Climate Registry Table 1.2   |  |
| Biogas  | kg CO2e/MMBtu             | 0              | 0              | Excludes CO2 because biogas is biogenic  | 2015 Climate Registry Table 1.2.9.1                                       |  |
| <b>Chemicals</b>  |                           |                |                |  |   |  |
| Polymer   | kg CO2e/kg polymer        | 9.00           | 9.00           | Emission for use of polymer  | BEAM default  |  |
| Lime  | kg CO2e/kg lime           | 0.90           | 0.90           | Emission for use of lime (stabilization)   | BEAM default  |  |
| Methanol  | kg CO2e/gal methanol      | 3.71           | 3.71           | Credit for methanol displaced  | NY Hunts Pt GHG SWEET model   |  |
| <b>Transportation Fuels</b>                                   |                           |                |                |  |   |  |
| Gasoline  | kg CO2e/L                 | 2.83           | 2.83           | Includes production emissions  | Elsayed et al., 2003  |  |
| Gasoline  | kg CO2e/L                 | 2.80           | 2.80           | Includes production emissions  | Biomass Energy Centre (UK)  |  |
| Gasoline  | kg CO2e/L                 | 2.32           | 2.32           | Combustion only (no production)  | 2015 Climate Registry Table 1.3   |  |
| Diesel  | kg CO2e/L                 | 3.14           | 3.14           | Includes production emissions  | Biomass Energy Centre (UK)  |  |
| Diesel  | kg CO2e/L                 | 2.70           | 2.70           | Combustion only (no production)  | 2015 Climate Registry Table 1.3   |  |
| <b>Transportation</b>   |                           |                |                |  |   |  |
| Fuel for biosolids land application                           | kg CO2e/WT solids applied | 4.55           | 4.55           |  | BEAM default  |  |
| Fuel for Composting Machinery                                 | Gallon/Day                | 274.00         | 274.00         | Front End Loader (3.5 gal/hr -> 8 hrs) [4], Vertical/ Horiz Aug Mixers (7 gph ->6 hrs) [2], Trommel Screen (1 gal/hr->6 hrs)[1], Grinder (12 gal/hr -> 6 hrs) [1]                                |   |  |
| Fuel for Soil Blending Machinery                              | Gallon/Day                | 234.00         | 234.00         | Front End Loader (3.5 gal/hr -> 8 hrs) [3], FEL (3.5 gal/hr -> 4 hrs) [1], Vertical/ Horiz Aug Mixers (7 gph ->6 hrs) [2], Trommel Screen (1 gal/hr->4 hrs)[1], Grinder (12 gal/hr -> 4 hrs) [1] |   |  |
| KC Fuel for Forestry Application                              | Gallon/WT                 | 0.44           | 0.44           | 11,000 gallons of Diesel per 25,000 WT (2018)  | King County Communication, Nov 2019                                       |  |
| KC Fuel for Biosolids Land Application                        | Gallon/WT                 | 0.32           | 0.32           | 33,000 gallons of Diesel per 103,000 WT (2018)   | King County Communication, Nov 2019                                       |  |
| Passenger Vehicle Mileage                                     | Miles/gallon gasoline     | 25.00          | 25.00          |  | https://www.fueleconomy.gov/  |  |
| Local Distribution Truck (full)                               | Miles/gallon diesel       | 6.00           | 6.00           |  |   |  |
| Local Distribution Truck (empty)                              | Miles/gallon diesel       | 10.00          | 10.00          |  |   |  |
| KC Biosolids Truck Hauling Mileage (full)                     | Miles/gallon diesel       | 4.18           | 4.18           |  | King County Communication, Nov 2019                                       |  |
| KC Biosolids Truck Hauling Mileage (empty)                    | Miles/gallon diesel       | 8.00           | 8.00           | Estimated  |   |  |
| KC Truck Capacity   | WT/truck                  | 31.00          | 31.00          |  | King County Communication, Nov 2019                                       |  |
| Local Distribution Truck Capacity                             | CY/truck                  | 18.00          | 18.00          | 15 CY for topsoil and 22 CY for mulch. Assume in between for compost   |   |  |
| Local Compost/ Soil Blend Capacity                            | CY/truck                  | 3.00           | 3.00           |  |   |  |
| <b>Transportation (Miles)</b>                                 |                           |                |                |  |   |  |
| WTP Transportation to Off-site processing, Roundtrip          | Miles                     | 30             | 30             | Distance to off-site composting, soil-blending, or pyrolysis   |   |  |
| Feedstock (Sand), Roundtrip                                   | Miles                     | 75             | 75             | Average distance to several local bulk aggregate companies   |   |  |
| Feedstock (Woodchips, Sawdust), Roundtrip                     | Miles                     | 160            | 160            | Distance From Renton to Hampton Lumber Mills (selected for size via google)  |   |  |
| Western Washington (Forestry/or local agriculture), Roundtrip | Miles                     | 70             | 70             |  | King County Communication, Nov 2019                                       |  |
| Eastern Washington (Agriculture), Roundtrip                   | Miles                     | 420            | 420            |  | King County Communication, Nov 2019                                       |  |
| Local Application (Compost or local retail), Roundtrip        | Miles                     | 25             | 25             |  | King County Communication, Nov 2019                                       |  |
| Regional Application (Biochar), Roundtrip                     | Miles                     | 200            | 200            |  |   |  |
| <b>End-use</b>  |                           |                |                |  |   |  |
| <b>Scenario 1</b>   |                           |                |                |  |   |  |
| Bulk Land Application   | %                         |                |                |  |   |  |
| Western Washington Split                                      | %                         | 10             | 10             |  |   |  |
| Eastern Washington Split                                      | %                         | 90             | 90             |  |   |  |
| <b>Scenario 2</b>   |                           |                |                |  |   |  |
| Bulk Land Application (South Plant)                           | WT/Day                    |                |                |  |   |  |
| Western Washington Split (100% Forestry)                      | %                         | 40             | 40             |  | King County Communication, Nov 2019                                       |  |
| Eastern Washington Split (100% Agriculture)                   | %                         | 60             | 60             |  | King County Communication, Nov 2019                                       |  |
| <b>Soil Blending (West Point)</b>                             |                           |                |                |  |   |  |
| Bagged  | %                         | 20             | 20             |  | King County Communication, Nov 2019                                       |  |
| Donated   | %                         | 10             | 10             |  | King County Communication, Nov 2019                                       |  |
| Bulk Wholesaler   | %                         | 40             | 40             |  |   |  |
| Bulk Retail   | %                         | 30             | 30             |  | King County Communication, Nov 2019                                       |  |
| <b>Composting (Brightwater)</b>                               |                           |                |                |  |   |  |
| Bagged  | %                         | 20             | 20             |  | King County Communication, Nov 2019                                       |  |



|  |                           |           |           |  |  |
|--|---------------------------|-----------|-----------|--|--|
| Donated                                      | %                         | 10        | 10        |  | King County Communication, Nov 2019      |
| Bulk Wholesaler                              | %                         | 40        | 40        |  |  |
| Bulk Retail                                  | %                         | 30        | 30        |  | King County Communication, Nov 2019      |
| Scenario 3                                   |                           |           |           |  |  |
| Biochar Retail                               | %                         | 100       | 100       |  |  |
| <b>Fertilizer Offset (BEAM)</b>              |                           |           |           |  |  |
| Nitrogen Amount Added                        | %                         | 4.00%     | 4.00%     | %N by dry weight   |  |
| Nitrogen Offset                              | kg CO2e/kg N applied      | -4        | -4        | Credit for N applied; Can assume 4% N by dry weight                                | BEAM default                             |
| Phosphorus Amount Added                      | %                         | 1.50%     | 1.50%     | %P by dry weight   |  |
| Phosphorus Offset                            | kg CO2e/kg P applied      | -2        | -2        | Credit for P applied; Can assume 1.5% P by dry weight                              | BEAM default                             |
| <b>Fertilizer Offset (King County)</b>       |                           |           |           |  |  |
| Nitrogen and Phosphorus Offset (Agriculture) | kg CO2e/ kg dry biosolids | -0.29     | -0.29     | Agriculture 1.54 (0.29 fertilizer offset, 1.25 accumulation of carbon in the soil) | King County Communication, December 2019 |
| Nitrogen and Phosphorus Offset (Forestry)    | kg CO2e/ kg dry biosolids | 0         | 0         | Forestry 1.0 (1.0 accumulation of carbon in the soil)                              | King County Communication, December 2019 |
| Nitrogen and Phosphorus Offset (Compost)     | kg CO2e/ kg dry biosolids | -0.29     | -0.29     | Compost 0.64 (0.29 fertilizer offset, 0.41 accumulation of carbon in the soil)     | King County Communication, December 2019 |
| <b>Sequestration (BEAM)</b>                  |                           |           |           |  |  |
| Land Application                             | kg CO2e/ kg dry biosolids | -0.25     | -0.25     |  | BEAM default                             |
| Mine Reclamation                             | kg CO2e/kg dry biosolids  | -1.3      | -1.3      |  | BEAM Data Table for BC copper mine       |
| Compost                                      | kg CO2e/ kg dry biosolids | -0.25     | -0.25     |  | BEAM default                             |
| Soil Blend                                   | kg CO2e/ kg dry biosolids | -0.25     | -0.25     |  | BEAM default                             |
| <b>Sequestration (King County)</b>           |                           |           |           |  |  |
| Land Application (Agriculture)               | kg CO2e/ kg dry biosolids | -1.25     | -1.25     | Agriculture 1.54 (0.29 fertilizer offset, 1.25 accumulation of carbon in the soil) | King County Communication, December 2019 |
| Land Application (Forestry)                  | kg CO2e/kg dry biosolids  | -1        | -1        | Forestry 1.0 (1.0 accumulation of carbon in the soil)                              | King County Communication, December 2019 |
| Compost                                      | kg CO2e/ kg dry biosolids | -0.41     | -0.41     | Compost 0.64 (0.29 fertilizer offset, 0.41 accumulation of carbon in the soil)     | King County Communication, December 2019 |
| Soil Blend                                   | kg CO2e/ kg dry biosolids | -0.41     | -0.41     | Assumed same as compost impacts  |  |
| <b>Fugitive Emissions</b>                    |                           |           |           |  |  |
| Digester (fixed cover)                       | of CH4 production         | 0.0001    | 0.0001    | Through pressure relief valve only; 10% gas loss for 10 hrs/yr                     | sjk estimate                             |
| Digester (floating cover)                    | of CH4 production         | 0.017     | 0.017     | Based on 80-ft dia digester and 4-in annulus w/o water bath for skirt              | sjk estimate                             |
| Sludge Dewatering (high s.g.)                | g CH4/L of sludge         | 0.000022  | 0.000022  | Assume 5% gas in sludge flow from well-mixed digester; no odor treatment           | sjk estimate                             |
| Sludge Dewatering (low s.g.)                 | g CH4/L sludge            | 0.086     | 0.086     | Assume 20% gas in sludge flow from poorly-mixed digester; no odor treatment        | sjk estimate                             |
| Sludge Dewatering with biofilter             | g CH4/ L sludge           | 0.013     | 0.013     | Assume 40% removal in inorganic media biofilter (20% for organic media)            | sjk estimate; Nikiema et al., 2005       |
| Sludge Drying                                | g CH4/L sludge            | 0.01      | 0.01      | Without RTO emission control; from residual and soluble gas                        | sjk estimate                             |
| Sludge Drying                                | g CH4/L sludge            | 0.0001    | 0.0001    | With RTO emission control at 1% slip (Andritz drier)                               | sjk est; E. Jacobson on RTO              |
| Cogen (recip engine; low eff)                | of CH4 to engine          | 0.02088   | 0.02088   |  | Willis et al. 2013                       |
| Cogen (recip engine; high eff)               | of CH4 to engine          | 0.00438   | 0.00438   |  | Willis et al. 2013                       |
| Cogen Turbine/Microturbine                   | of CH4 to turbine         | 0.00012   | 0.00012   |  | Willis et al. 2013                       |
| Boiler (very efficient)                      | of CH4 to boiler          | 0.00005   | 0.00005   | Also see "Heating (boiler)" above for alternative CH4 and N2O emissions            | Willis et al. 2013                       |
| Gas upgrading with thermal ox                | of CH4 to scrubber        | 0.001     | 0.001     | PA and membrane scrubbers 10% slip and 1% slip from thermal oxidizer               | Eron Jacobson                            |
| Gas upgrading                                | of CH4 to scrubber        | 0.015     | 0.015     | Water solvent w/o RTO 1.5% slip  | Eron Jacobson                            |
| Fuel cell                                    | of CH4 to fuel cell       | 0.0105    | 0.0105    | Requires gas upgrade prior to fuel cell  | Willis et al. 2013                       |
| Flare (candle stick)                         | of CH4 to flare           | 0.05      | 0.05      |  | Willis et al. 2013                       |
| Flare (modern enclosed)                      | of CH4 to flare           | 0.004     | 0.004     | BC specs 1%; typically achieve 0.4%  | sjk estimate                             |
| Flare (efficient)                            | of CH4 to flare           | 0.003     | 0.003     |  | BEAM Data Tables                         |
| Flare (enclosed; low NOx)                    | of CH4 to flare           | 0.00003   | 0.00003   |  | Willis et al. 2013                       |
| Land Application (High), CH4                 | g CH4/L sludge            | 0.01      | 0.01      | From residual and soluble gas after dewatering; same as drying                     | sjk estimate                             |
| Land Application (High), N2O                 | kg N2O/ kg N              | 0.50%     | 0.005     | From residual and soluble gas after dewatering; same as drying                     | sjk estimate                             |
| Land Application (Low), CH4                  | g CH4/L sludge            | 0.01      | 0.01      | From residual and soluble gas after dewatering; same as drying                     | sjk estimate                             |
| Land Application (Low), N2O                  | kg N2O/ kg N              | 0.002     | 0.002     | From residual and soluble gas after dewatering; same as drying                     | sjk estimate                             |
| Landfill (poor capture), CH4 Capture         |                           | 0.2       | 0.2       | Assume 40% additional VSR (sjk estimate from Sacramento FSLs)                      | BEAM Data Tables                         |
| Landfill (poor capture), CH4 Oxidation       |                           | 0.1       | 0.1       | Assume 40% additional VSR (sjk estimate from Sacramento FSLs)                      | BEAM Data Tables                         |
| Landfill (good capture), CH4 Capture         |                           | 0.75      | 0.75      | Assume 40% additional VSR (sjk estimate from Sacramento FSLs)                      | BEAM Data Tables                         |
| Landfill (good capture), CH4 Oxidation       |                           | 0.4       | 0.4       | Assume 40% additional VSR (sjk estimate from Sacramento FSLs)                      | BEAM Data Tables                         |
| Sludge Lagoon, CH4 Capture                   |                           | 0         | 0         | Assume 40% additional VSR (sjk estimate from Sacramento FSLs)                      | BEAM Data Tables                         |
| Sludge Lagoon, CH4 Oxidation                 |                           | 0         | 0         | Assume 40% additional VSR (sjk estimate from Sacramento FSLs)                      | BEAM Data Tables                         |
| Compost (uncovered)                          | kg CH4/kg C dry wt        | 0.01      | 0.01      |  | BEAM Data Tables                         |
| Compost (uncovered)                          | kg N2O/kg N dry wt        | 0.013     | 0.013     |  | BEAM Data Tables                         |
| Compost (covered with biofilter)             | kg CH4/kg C dry wt        | 0.006     | 0.006     | Assume 40% removal in inorganic media biofilter (20% for organic media)            | sjk estimate; Nikiema et al., 2005       |
| Compost (with C:N above 30)                  |                           |           |           |  |  |
| Soil Blend, CH4                              | kg CH4/kg dry wt          | 0.01      | 0.01      | Assume same as uncovered compost   | sjk estimate                             |
| Soil Blend, N2O                              | kg NO2 initial N          | 0.013     | 0.013     | Assume same as uncovered compost   | sjk estimate                             |
| Incineration, CH4                            | kg CH4/ kg dry solids     | 0.0000485 | 0.0000485 | Assumes 20% TS cake  | BEAM Data Tables                         |
| Incineration, N2O                            | kg N2O/kg dry wt          | 0.00049   | 0.00049   | Assumes 20% TS cake  | BEAM Data Tables                         |









| S1 Output Summary                   |       |
|-------------------------------------|-------|
| Final TS, Wet (WT/D)                | 0     |
| NG Req. (cfh)                       | 8706  |
| NG (LHV MMBtu/h)                    | 8     |
| Net heat (MMBtu/h)                  | 11    |
| Electricity Req. (kWh)              | 3138  |
| Power Generation (kWh)              | 1760  |
| Net Power (kWh)                     | -1378 |
| No. of Trucks Required (trucks/day) | 19    |
| Digester Gas Produced (scfm)**      | 3325  |
| Methane Produced (scfm)**           | 1995  |
| Scrubbed Gas (scfm)**               | 700   |
| Polymer Use (lb/day)                | 461.1 |

Scenario 1 - [Baseline] 100% Class B application with MAD at all three plants







West Point

| Feedstock   | Stabilization   | Gas Utilization  |   |  | Dewatering  | End Use   |
|---|---|--|---|--|---|---|
| <p><b>225860</b> PPD<br/>                     Dry Mass Flow<br/>                     TS 6.1%<br/>                     VS 81%<br/>                     VSR 64%<br/>                     Calorific Value 10,000 Btu/lb VS</p> <p>Feedstock Type<br/>                     PS + WAS</p> <p>Energy Consumption<br/>                     0 hp<br/>                     90% Efficiency</p> <p>Duty No. 5</p>   | <p>Digester (Meso)</p> <p>VSR 64.0%</p> <p>Sludge Inlet Temp 65 F<br/>                     Operation Temp 98 F<br/>                     555 Btu/cf<br/>                     15 cftb VS<br/>                     5.09 MMBtu/hr</p> <p>Energy Consumption<br/>                     40 hp/unit<br/>                     100% Efficiency<br/>                     Shell Heat Loss 15%</p> <p>Duty No. 5</p>   | <p>CHP Engine</p> <p>909 NG LHV</p> <p>Therm Eff. 36%</p> <p>Nat gas usage, cfh 0<br/>                     Biogas Fuel use 44%</p> <p>Engine Electrical Eff. 34%<br/>                     Heat Recovery 6.36 MMBtu/hr</p> <p>Energy Consumption<br/>                     289 hp/unit<br/>                     90% Efficiency</p> <p>Duty No. 1</p>   | <p>Boiler</p> <p>909 NG LHV</p> <p>Therm Eff. 85%</p> <p>Nat gas usage, cfh 0<br/>                     Biogas Fuel use 10%</p> <p>Heat Recovery 2.02 MMBtu/hr</p> <p>Energy Consumption<br/>                     40 hp/unit<br/>                     90% Efficiency</p> <p>Duty No. 2</p>   | <p>Flare</p> <p>Energy Consumption<br/>                     0 hp/unit<br/>                     90% Efficiency</p> <p>Duty No. 2</p>  | <p>Centrifuge</p> <p>92% Capture<br/>                     29% TS</p> <p>Energy Consumption<br/>                     225 hp/unit<br/>                     90% Efficiency</p> <p>Duty No. 4<br/>                     Polymer Use 30 lbs/DT</p>  | <p>100% Land Application</p> <p>PPD<br/>                     100295<br/>                     28.5%<br/>                     61%</p> <p>End Use<br/>                     Land Application</p> <p>Energy Consumption<br/>                     0 hp/unit<br/>                     90% Efficiency</p> <p>Duty No. 4<br/>                     Polymer Use 30 lbs/DT</p>  |
| <p>Wet Mass Flow 154,276 lb/hr<br/>                     Dry Mass Flow 9,411 lb/hr<br/>                     VS 7,620 lb/hr<br/>                     Water 144,865 lb/hr<br/>                     TS 6.10%<br/>                     VS 81%<br/>                     VSR 4,878 lb/hr<br/>                     Wet flow 308.3 gpm<br/>                     Calorific Value 10,000 Btu/lb VS<br/>                     Electrical Demand 0.0 kW<br/>                     Unit Heat Bal. 0 MMBtu/hr<br/>                     Total Heat Bal. 0 MMBtu/hr<br/>                     Unit Aux. Fuel Bal. 0.00 MMBtu/hr<br/>                     Cum. Aux. Fuel Bal. 0.00 MMBtu/hr<br/>                     Unit Process Fuel Bal. 0.00 MMBtu/hr<br/>                     Cum Unit Process Fuel Bal. 0.00 MMBtu/hr<br/>                     Generated Steam 0 lb/hr<br/>                     Power Generation 0 MW<br/>                     No of Trucks Required 0.00 trucks/day<br/>                     Vehicle Fuel Consumption 0 gal/day<br/>                     Digester Gas Produced 0 scfm<br/>                     Methane Production 0 scfm<br/>                     Methane Utilized 0 scfm<br/>                     Scrubbed Gas 0 scfm<br/>                     Unit Polymer Use 0 lb/day</p> | <p>149,398 lb/hr<br/>                     4,533 lb/hr<br/>                     54.4 DTPD<br/>                     2,743 lb/hr<br/>                     144,865 lb/hr<br/>                     3.03%<br/>                     61%<br/>                     0 lb/hr<br/>                     298.6 gpm<br/>                     10,000 Btu/lb VS<br/>                     149.2 kW<br/>                     -5.85 MMBtu/hr<br/>                     -5.85 MMBtu/hr<br/>                     0.00 MMBtu/hr<br/>                     0.00 MMBtu/hr<br/>                     40.61 MMBtu/hr<br/>                     40.61 MMBtu/hr<br/>                     0 lb/hr<br/>                     0.00 MW<br/>                     0.00 trucks/day<br/>                     0 gal/day<br/>                     1219 scfm<br/>                     732 scfm<br/>                     0 scfm<br/>                     0 scfm<br/>                     0 lb/day</p> | <p>149,398 lb/hr<br/>                     4,533 lb/hr<br/>                     54.4 DTPD<br/>                     2,743 lb/hr<br/>                     144,865 lb/hr<br/>                     3.03%<br/>                     61%<br/>                     0 lb/hr<br/>                     298.6 gpm<br/>                     10,000 Btu/lb VS<br/>                     239.7 kW<br/>                     6.36 MMBtu/hr<br/>                     0.50 MMBtu/hr<br/>                     0.00 MMBtu/hr<br/>                     0.00 MMBtu/hr<br/>                     -17.66 MMBtu/hr<br/>                     22.94 MMBtu/hr<br/>                     0 lb/hr<br/>                     1.76 MW<br/>                     0.00 trucks/day<br/>                     0 gal/day<br/>                     0 scfm<br/>                     0 scfm<br/>                     -318 scfm<br/>                     0 scfm<br/>                     0 lb/day</p> | <p>149,398 lb/hr<br/>                     4,533 lb/hr<br/>                     54.4 DTPD<br/>                     2,743 lb/hr<br/>                     144,865 lb/hr<br/>                     3.03%<br/>                     61%<br/>                     0 lb/hr<br/>                     298.6 gpm<br/>                     10,000 Btu/lb VS<br/>                     65.3 kW<br/>                     2.02 MMBtu/hr<br/>                     2.52 MMBtu/hr<br/>                     0.00 MMBtu/hr<br/>                     0.00 MMBtu/hr<br/>                     -2.38 MMBtu/hr<br/>                     20.57 MMBtu/hr<br/>                     0 lb/hr<br/>                     0.00 MW<br/>                     0.00 trucks/day<br/>                     0 gal/day<br/>                     0 scfm<br/>                     0 scfm<br/>                     -43 scfm<br/>                     0 scfm<br/>                     0 lb/day</p> | <p>149,398 lb/hr<br/>                     4,533 lb/hr<br/>                     54.4 DTPD<br/>                     2,743 lb/hr<br/>                     144,865 lb/hr<br/>                     3.03%<br/>                     61%<br/>                     0 lb/hr<br/>                     298.6 gpm<br/>                     10,000 Btu/lb VS<br/>                     0.0 kW<br/>                     2.52 MMBtu/hr<br/>                     0.00 MMBtu/hr<br/>                     0.00 MMBtu/hr<br/>                     -20.57 MMBtu/hr<br/>                     0.00 MMBtu/hr<br/>                     0 lb/hr<br/>                     0.00 MW<br/>                     0.00 trucks/day<br/>                     0 gal/day<br/>                     0 scfm<br/>                     0 scfm<br/>                     -371 scfm<br/>                     0 scfm<br/>                     0 lb/day</p> | <p>14,663 lb/hr<br/>                     4,179 lb/hr<br/>                     50.1 DTPD<br/>                     2,528 lb/hr<br/>                     10,484 lb/hr<br/>                     28.50%<br/>                     61%<br/>                     0 lb/hr<br/>                     29.3 gpm<br/>                     10,000 Btu/lb VS<br/>                     746.0 kW<br/>                     0.00 MMBtu/hr<br/>                     2.52 MMBtu/hr<br/>                     0.00 MMBtu/hr<br/>                     0.00 MMBtu/hr<br/>                     0.00 MMBtu/hr<br/>                     0.00 MMBtu/hr<br/>                     0 lb/hr<br/>                     0.00 MW<br/>                     0.00 trucks/day<br/>                     0 gal/day<br/>                     0 scfm<br/>                     0 scfm<br/>                     0 scfm<br/>                     0 scfm<br/>                     1632 lb/day</p> | <p>14,663 lb/hr<br/>                     4,179 lb/hr<br/>                     50.1 DTPD<br/>                     2,528 lb/hr<br/>                     10,484 lb/hr<br/>                     28.50%<br/>                     61%<br/>                     0 lb/hr<br/>                     29.3 gpm<br/>                     10,000 Btu/lb VS<br/>                     0.0 kW<br/>                     0.00 MMBtu/hr<br/>                     2.52 MMBtu/hr<br/>                     0.00 MMBtu/hr<br/>                     0.00 MMBtu/hr<br/>                     0.00 MMBtu/hr<br/>                     0 lb/hr<br/>                     0.00 MW<br/>                     6.00 trucks/day<br/>                     0 gal/day<br/>                     0 scfm<br/>                     0 scfm<br/>                     0 scfm<br/>                     0 scfm<br/>                     0 lb/day</p> |

**South Plant**

| Feedstock   | Stabilization  | Gas Utilization  |   |  |   | Dewatering   | End Use   |
|---|--|--|---|--|---|--|---|
| <p>263760 PPD<br/>6.2%<br/>85.88%<br/>60.0%<br/>10,000 Btu/lb VS</p> <p>Feedstock Type<br/>PS + WAS</p> <p>Energy Consumption<br/>0 hplunit<br/>90% Efficiency</p>   | <p>Digester (Meso)</p> <p>VSR 60.0%</p> <p>Sludge Inlet Temp<br/>65 F<br/>Operation Temp<br/>98 F<br/>550 Btu/cf<br/>16.24 cflb VS<br/>5.85 MMBtu/hr</p> <p>Energy Consumption<br/>40 hplunit<br/>100% Efficiency<br/>Shell Heat Loss<br/>15%</p> <p>Duty No. 4</p>   | <p>CHP Engine 909<br/>NG LHV</p> <p>Therm Eff. 38%</p> <p>Nat gas usage, cfh<br/>0<br/>Biogas Fuel use 0%</p> <p>Engine Electrical Eff.<br/>30%<br/>Heat Recovery<br/>0.00 MMBtu/hr</p> <p>Energy Consumption<br/>145 hplunit<br/>90% Efficiency</p> <p>Duty No. 0</p>    | <p>Boiler 909<br/>NG LHV</p> <p>Therm Eff. 85%</p> <p>Nat gas usage, cfh<br/>8,706<br/>Biogas Fuel use 0%</p> <p>Heat Recovery<br/>6.73 MMBtu/hr</p> <p>Energy Consumption<br/>40 hplunit<br/>90% Efficiency</p> <p>Duty No. 2</p>   | <p>Biogas Upgrading</p> <p>Nat gas usage, cfh<br/>0<br/>Biogas Fuel use 85%</p> <p>Energy Consumption<br/>738 hplunit<br/>100% Efficiency</p> <p>Duty No. 1</p>   | <p>Flare</p> <p>Energy Consumption<br/>0 hplunit<br/>90% Efficiency</p> <p>Duty No. 2</p>    | <p>Centrifuge</p> <p>95% Capture<br/>23% TS</p> <p>Energy Consumption<br/>225 hplunit<br/>90% Efficiency</p> <p>Duty No. 4<br/>Polymer Use<br/>35 lbs/DT</p>    | <p>100% Land Application</p> <p>121334 PPD<br/>22.9%<br/>71%</p> <p>End Use<br/>Land Application</p> <p>Energy Consumption<br/>0 hplunit<br/>90% Efficiency</p>  |
| <p>177,258 lb/hr<br/>10,990 lb/hr<br/>131.9 DTPD<br/>9,439 lb/hr<br/>166,268 lb/hr<br/>6.20%<br/>86%<br/>5,666 lb/hr<br/>354.2 gpm<br/>10,000 Btu/lb VS<br/>0.0 kW<br/>0 MMBtu/hr<br/>0 MMBtu/hr<br/>0 MMBtu/hr<br/>0 MMBtu/hr<br/>0 MMBtu/hr<br/>0 MMBtu/hr<br/>0 MMBtu/hr<br/>0 lb/hr<br/>0 MW<br/>0.00 trucks/day<br/>0 gal/day<br/>0 scfm<br/>0 scfm<br/>0 scfm<br/>0 scfm<br/>0 lb/day</p> | <p>171,592 lb/hr<br/>5,324 lb/hr<br/>63.9 DTPD<br/>3,773 lb/hr<br/>166,268 lb/hr<br/>3.10%<br/>71%<br/>0 lb/hr<br/>342.9 gpm<br/>10,000 Btu/lb VS<br/>119.4 kW<br/>0.00 MMBtu/hr<br/>-6.73 MMBtu/hr<br/>0.00 MMBtu/hr<br/>0.00 MMBtu/hr<br/>0.00 MMBtu/hr<br/>50.61 MMBtu/hr<br/>50.61 MMBtu/hr<br/>0 lb/hr<br/>0 MW<br/>0.00 trucks/day<br/>1534 scfm<br/>920 scfm<br/>0 scfm<br/>0 scfm<br/>0 lb/day</p> | <p>171,592 lb/hr<br/>5,324 lb/hr<br/>63.9 DTPD<br/>3,773 lb/hr<br/>166,268 lb/hr<br/>3.10%<br/>71%<br/>0 lb/hr<br/>342.9 gpm<br/>10,000 Btu/lb VS<br/>66.3 kW<br/>6.73 MMBtu/hr<br/>0.00 MMBtu/hr<br/>-6.73 MMBtu/hr<br/>7.91 MMBtu/hr<br/>7.91 MMBtu/hr<br/>0.00 MMBtu/hr<br/>50.61 MMBtu/hr<br/>50.61 MMBtu/hr<br/>0 lb/hr<br/>0 MW<br/>0.00 trucks/day<br/>0 scfm<br/>0 scfm<br/>0 scfm<br/>0 scfm<br/>0 lb/day</p> | <p>171,592 lb/hr<br/>5,324 lb/hr<br/>63.9 DTPD<br/>3,773 lb/hr<br/>166,268 lb/hr<br/>3.10%<br/>71%<br/>0 lb/hr<br/>342.9 gpm<br/>10,000 Btu/lb VS<br/>550.4 kW<br/>0.00 MMBtu/hr<br/>0.00 MMBtu/hr<br/>0.00 MMBtu/hr<br/>7.91 MMBtu/hr<br/>-42.76 MMBtu/hr<br/>7.84 MMBtu/hr<br/>0 lb/hr<br/>0 MW<br/>0.00 trucks/day<br/>0 scfm<br/>0 scfm<br/>-778 scfm<br/>700 scfm<br/>0 lb/day</p> | <p>171,592 lb/hr<br/>5,324 lb/hr<br/>63.9 DTPD<br/>3,773 lb/hr<br/>166,268 lb/hr<br/>3.10%<br/>71%<br/>0 lb/hr<br/>342.9 gpm<br/>10,000 Btu/lb VS<br/>0.0 kW<br/>0.00 MMBtu/hr<br/>0.00 MMBtu/hr<br/>0.00 MMBtu/hr<br/>7.91 MMBtu/hr<br/>-7.84 MMBtu/hr<br/>0.00 MMBtu/hr<br/>0 lb/hr<br/>0 MW<br/>0.00 trucks/day<br/>0 gal/day<br/>0 scfm<br/>0 scfm<br/>-143 scfm<br/>0 scfm<br/>0 lb/day</p> | <p>22,077 lb/hr<br/>5,056 lb/hr<br/>60.7 DTPD<br/>3,583 lb/hr<br/>17,021 lb/hr<br/>22.90%<br/>71%<br/>0 lb/hr<br/>44.1 gpm<br/>10,000 Btu/lb VS<br/>746.0 kW<br/>0.00 MMBtu/hr<br/>0.00 MMBtu/hr<br/>0.00 MMBtu/hr<br/>7.91 MMBtu/hr<br/>0.00 MMBtu/hr<br/>0.00 MMBtu/hr<br/>0 lb/hr<br/>0 MW<br/>0.00 trucks/day<br/>0 gal/day<br/>0 scfm<br/>0 scfm<br/>0 scfm<br/>0 scfm<br/>2236 lb/day</p> | <p>22,077 lb/hr<br/>5,056 lb/hr<br/>60.7 DTPD<br/>3,583 lb/hr<br/>17,021 lb/hr<br/>22.90%<br/>71%<br/>0 lb/hr<br/>44.1 gpm<br/>10,000 Btu/lb VS<br/>0.0 kW<br/>0.00 MMBtu/hr<br/>0.00 MMBtu/hr<br/>0.00 MMBtu/hr<br/>7.91 MMBtu/hr<br/>0.00 MMBtu/hr<br/>0.00 MMBtu/hr<br/>0 lb/hr<br/>0 MW<br/>9.00 trucks/day<br/>0 gal/day<br/>0 scfm<br/>0 scfm<br/>0 scfm<br/>0 scfm<br/>0 lb/day</p> |   |

**Brightwater**

| Feedstock  | Stabilization   | Gas Utilization   | Dewatering   | End Use  |  |
|--|---|---|--|--|--|
| <p>93910 PPD<br/>5.8%<br/>90%<br/>61%<br/>10,000 Btu/lb VS</p> <p>Feedstock Type<br/>PS + WAS</p> <p>Energy Consumption<br/>0 hpl/unit<br/>90% Efficiency</p>   | <p>Digester (Meso)</p> <p>VSR 60.9%</p> <p>Sludge Inlet Temp F<br/>65<br/>Operation Temp F<br/>98<br/>550 Btu/cf<br/>16 cflb VS<br/>2.23 MMBtu/hr</p> <p>Energy Consumption<br/>40 hpl/unit<br/>100% Efficiency<br/>Shell Heat Loss<br/>15%</p> <p>Duty No. 3</p>                                  | <p>Boiler</p> <p>909 NG LHV</p> <p>Therm Eff. 85%</p> <p>Nat gas usage, cfm<br/>0<br/>70%</p> <p>Heat Recovery<br/>11.22 MMBtu/hr</p> <p>Energy Consumption<br/>40 hpl/unit<br/>90% Efficiency</p> <p>Duty No. 1</p>   | <p>Flare</p> <p>Energy Consumption<br/>0 hpl/unit<br/>90% Efficiency</p> <p>Duty No. 1</p>    | <p>Centrifuge</p> <p>93% Capture<br/>20% TS</p> <p>Energy Consumption<br/>200 hpl/unit<br/>90% Efficiency</p> <p>Duty No. 2<br/>Polymer Use<br/>35 lbs/DT</p>    | <p>39295 PPD<br/>100% Land Application<br/>20.0%<br/>78%</p> <p>End Use<br/>Land Application</p> <p>Energy Consumption<br/>0 hpl/unit<br/>90% Efficiency</p>    |
| <p>67,464 lb/hr<br/>3,913 lb/hr<br/>47.0 DTPD<br/>3,517 lb/hr<br/>63,551 lb/hr<br/>5.80%<br/>90%<br/>2,143 lb/hr<br/>134.8 gpm<br/>10,000 Btu/lb VS<br/>0 kW<br/>0 MMBtu/hr<br/>0 MMBtu/hr<br/>0 MMBtu/hr<br/>0 MMBtu/hr<br/>0 MMBtu/hr<br/>0 MMBtu/hr<br/>0 MMBtu/hr<br/>0 MMBtu/hr<br/>0 MW<br/>0.00 trucks/day<br/>0 gal/day<br/>0 scfm<br/>0 scfm<br/>0 scfm<br/>0 scfm<br/>0 lb/day</p> | <p>65,321 lb/hr<br/>1,770 lb/hr<br/>21.2 DTPD<br/>1,374 lb/hr<br/>63,551 lb/hr<br/>2.71%<br/>78%<br/>0 lb/hr<br/>130.5 gpm<br/>10,000 Btu/lb VS<br/>89.5 kW<br/>-2.56 MMBtu/hr<br/>-2.56 MMBtu/hr<br/>0.00 MMBtu/hr<br/>0.00 MMBtu/hr<br/>18.86 MMBtu/hr<br/>18.86 MMBtu/hr<br/>0 lb/hr<br/>0 MW<br/>0.00 trucks/day<br/>571 scfm<br/>343 scfm<br/>0 scfm<br/>0 scfm<br/>0 lb/day</p> | <p>65,321 lb/hr<br/>1,770 lb/hr<br/>21.2 DTPD<br/>1,374 lb/hr<br/>63,551 lb/hr<br/>2.71%<br/>78%<br/>0 lb/hr<br/>130.5 gpm<br/>10,000 Btu/lb VS<br/>33.2 kW<br/>11.22 MMBtu/hr<br/>8.66 MMBtu/hr<br/>0.00 MMBtu/hr<br/>0.00 MMBtu/hr<br/>-13.20 MMBtu/hr<br/>5.66 MMBtu/hr<br/>0 lb/hr<br/>0 MW<br/>0.00 trucks/day<br/>0 scfm<br/>0 scfm<br/>-240 scfm<br/>0 scfm<br/>0 lb/day</p> | <p>65,321 lb/hr<br/>1,770 lb/hr<br/>21.2 DTPD<br/>1,374 lb/hr<br/>63,551 lb/hr<br/>2.71%<br/>78%<br/>0 lb/hr<br/>130.5 gpm<br/>10,000 Btu/lb VS<br/>0.0 kW<br/>0.00 MMBtu/hr<br/>8.66 MMBtu/hr<br/>0.00 MMBtu/hr<br/>0.00 MMBtu/hr<br/>-5.66 MMBtu/hr<br/>0.00 MMBtu/hr<br/>0 lb/hr<br/>0 MW<br/>0.00 trucks/day<br/>0 scfm<br/>0 scfm<br/>-103 scfm<br/>0 scfm<br/>0 lb/day</p> | <p>8,186 lb/hr<br/>1,637 lb/hr<br/>19.6 DTPD<br/>1,271 lb/hr<br/>6,549 lb/hr<br/>20.00%<br/>78%<br/>0 lb/hr<br/>16.4 gpm<br/>10,000 Btu/lb VS<br/>331.6 kW<br/>0.00 MMBtu/hr<br/>8.66 MMBtu/hr<br/>0.00 MMBtu/hr<br/>0.00 MMBtu/hr<br/>0.00 MMBtu/hr<br/>0.00 MMBtu/hr<br/>0.00 MMBtu/hr<br/>0 lb/hr<br/>0 MW<br/>0.00 trucks/day<br/>0 gal/day<br/>0 scfm<br/>0 scfm<br/>0 scfm<br/>0 scfm<br/>743 lb/day</p> | <p>8,186 lb/hr<br/>1,637 lb/hr<br/>19.6 DTPD<br/>1,271 lb/hr<br/>6,549 lb/hr<br/>20.00%<br/>78%<br/>0 lb/hr<br/>16.4 gpm<br/>10,000 Btu/lb VS<br/>0.0 kW<br/>0.00 MMBtu/hr<br/>8.66 MMBtu/hr<br/>0.00 MMBtu/hr<br/>0.00 MMBtu/hr<br/>0.00 MMBtu/hr<br/>0.00 MMBtu/hr<br/>0 lb/hr<br/>0 MW<br/>4.00 trucks/day<br/>0 gal/day<br/>0 scfm<br/>0 scfm<br/>0 scfm<br/>0 scfm<br/>0 lb/day</p> |

| S2 Output Summary                   |       |
|-------------------------------------|-------|
| Final TS, Wet (WT/D)                | 0     |
| NG Req. (cfm)                       | 15611 |
| NG (LHV MMBtu/h)                    | 14    |
| Net heat (MMBtu/h)                  | 9     |
| Electricity Req. (kWh)              | 4222  |
| Power Generation (kWh)              | 1886  |
| Net Power (kWh)                     | -2336 |
| No. of Trucks Required (trucks/day) | 34    |
| Digester Gas Produced (scfm)**      | 3419  |
| Methane Produced (scfm)**           | 2052  |
| Scrubbed Gas (scfm)**               | 708   |
| Polymer Use (lb/day)                | 6359  |













Scenario 2 - TAD with Batch Tanks at West Point to Soil Blending, Cambi at South Plant to direct Land App, and Brightwater with MAD and Off-site Composting

West Point

Off-site Soil Blending

| Feedstock                             |  |  | Stabilization            |  | Energy Recovery           |  | Gas Utilization                |            |  | Dewatering                    |  | End Use                      |  | Feedstock                      |  | Feedstock                     |  | Feedstock                    |  | End Use                      |  |                              |  |
|---------------------------------------|--|--|--------------------------|--|---------------------------|--|--------------------------------|------------|--|-------------------------------|--|------------------------------|--|--------------------------------|--|-------------------------------|--|------------------------------|--|------------------------------|--|------------------------------|--|
| Dry Mass Flow 225860 PPD              |  |  | Digester (Thermo)        |  | HEX                       |  | CHP Engine                     |            |  | Boiler                        |  | Flare                        |  | Centrifuge                     |  | 100% Off-Site Soil Blending   |  | Feedstock                    |  | Feedstock                    |  | Local Retail                 |  |
| TS 6.1%                               |  |  | VSR 68.0%                |  |                           |  | 909 NG LHV                     |            |  | 909 NG LHV                    |  |                              |  | 92% Capture TS                 |  | 93568 PPD                     |  | 45963 PPD                    |  | 252634 PPD                   |  | 392165 PPD                   |  |
| VS 81%                                |  |  |                          |  |                           |  |                                |            |  |                               |  |                              |  | 28.5%                          |  | 28.5%                         |  | 60.0%                        |  | 95.0%                        |  | 58.5%                        |  |
| VSR 68%                               |  |  |                          |  |                           |  |                                |            |  |                               |  |                              |  | 58%                            |  | 57.66%                        |  | 95.00%                       |  | 0.00%                        |  | 25%                          |  |
| Calorific Value 10,000 Btu/lb VS      |  |  |                          |  |                           |  |                                |            |  |                               |  |                              |  | 10,000 Btu/lb VS               |  | 10,000 Btu/lb VS              |  | 10,000 Btu/lb VS             |  | 10,000 Btu/lb VS             |  | 10,000 Btu/lb VS             |  |
| Feedstock Type PS + WAS               |  |  |                          |  |                           |  |                                |            |  |                               |  |                              |  | End Use Off-Site Soil Blending |  | Feedstock Type Dewatered Cake |  | Feedstock Type Sawdust       |  | Feedstock Type Fine Sand     |  | End Use Local Retail         |  |
| Energy Consumption 0 hp               |  |  | Energy Consumption 40 hp |  | Energy Consumption 150 hp |  | Energy Consumption 145 hp/unit |            |  | Energy Consumption 40 hp/unit |  | Energy Consumption 0 hp/unit |  | Energy Consumption 225 hp/unit |  | Energy Consumption 0 hp/unit  |  | Energy Consumption 0 hp/unit |  | Energy Consumption 0 hp/unit |  | Energy Consumption 0 hp/unit |  |
| Efficiency 90%                        |  |  | Efficiency 90%           |  | Efficiency 90%            |  | Efficiency 90%                 |            |  | Efficiency 90%                |  | Efficiency 90%               |  | Efficiency 90%                 |  | Efficiency 90%                |  | Efficiency 90%               |  | Efficiency 90%               |  | Efficiency 90%               |  |
| Duty No. 5                            |  |  | Duty No. 1               |  | Duty No. 2                |  |                                | Duty No. 2 |  | Duty No. 2                    |  | Duty No. 4                   |  | Duty No. 30                    |  |                               |  |                              |  |                              |  | Duty No. 1                   |  |
|                                       |  |  |                          |  |                           |  |                                |            |  |                               |  |                              |  |                                |  |                               |  |                              |  |                              |  |                              |  |
| Wet Mass Flow 154,276 lb/hr           |  |  | 149,094 lb/hr            |  | 149,094 lb/hr             |  | 149,094 lb/hr                  |            |  | 149,094 lb/hr                 |  | 149,094 lb/hr                |  | 13,680 lb/hr                   |  | 13,680 lb/hr                  |  | 16,871 lb/hr                 |  | 27,952 lb/hr                 |  | 27,952 lb/hr                 |  |
| Dry Mass Flow 9,411 lb/hr             |  |  | 4,229 lb/hr              |  | 4,229 lb/hr               |  | 4,229 lb/hr                    |            |  | 4,229 lb/hr                   |  | 4,229 lb/hr                  |  | 3,899 lb/hr                    |  | 3,899 lb/hr                   |  | 5,814 lb/hr                  |  | 16,340 lb/hr                 |  | 16,340 lb/hr                 |  |
| VS 7,620 lb/hr                        |  |  | 2,439 lb/hr              |  | 2,439 lb/hr               |  | 2,439 lb/hr                    |            |  | 2,439 lb/hr                   |  | 2,439 lb/hr                  |  | 2,248 lb/hr                    |  | 2,248 lb/hr                   |  | 4,067 lb/hr                  |  | 11,612 lb/hr                 |  | 11,612 lb/hr                 |  |
| Water 144,865 lb/hr                   |  |  | 144,865 lb/hr            |  | 144,865 lb/hr             |  | 144,865 lb/hr                  |            |  | 144,865 lb/hr                 |  | 144,865 lb/hr                |  | 9,781 lb/hr                    |  | 9,781 lb/hr                   |  | 11,058 lb/hr                 |  | 11,612 lb/hr                 |  | 11,612 lb/hr                 |  |
| TS 6.10%                              |  |  | 2.84%                    |  | 2.84%                     |  | 2.84%                          |            |  | 2.84%                         |  | 2.84%                        |  | 28.50%                         |  | 28.50%                        |  | 28.50%                       |  | 34.46%                       |  | 58.46%                       |  |
| VSR 81%                               |  |  | 58%                      |  | 58%                       |  | 58%                            |            |  | 58%                           |  | 58%                          |  | 58%                            |  | 58%                           |  | 70%                          |  | 25%                          |  | 25%                          |  |
| Wet flow 5,182 lb/hr                  |  |  | 0 lb/hr                  |  | 0 lb/hr                   |  | 0 lb/hr                        |            |  | 0 lb/hr                       |  | 0 lb/hr                      |  | 0 lb/hr                        |  | 0 lb/hr                       |  | 0 lb/hr                      |  | 0 lb/hr                      |  | 0 lb/hr                      |  |
| Calorific Value 308.3 gpm             |  |  | 297.9 gpm                |  | 297.9 gpm                 |  | 297.9 gpm                      |            |  | 297.9 gpm                     |  | 297.9 gpm                    |  | 27.3 gpm                       |  | 27.3 gpm                      |  | 33.7 gpm                     |  | 55.9 gpm                     |  | 55.9 gpm                     |  |
| Electrical Demand 10,000 Btu/lb VS    |  |  | 10,000 Btu/lb VS         |  | 10,000 Btu/lb VS          |  | 10,000 Btu/lb VS               |            |  | 10,000 Btu/lb VS              |  | 10,000 Btu/lb VS             |  | 0.0 Btu/lb VS                  |  | 10,000 Btu/lb VS              |  | 10,000 Btu/lb VS             |  | 10,000 Btu/lb VS             |  | 10,000 Btu/lb VS             |  |
| Unit Heat Bal. 0 MMBtu/hr             |  |  | -11.71 MMBtu/hr          |  | 3.24 MMBtu/hr             |  | 6.82 MMBtu/hr                  |            |  | 0.51 MMBtu/hr                 |  | 0.00 MMBtu/hr                |  | 0.00 MMBtu/hr                  |  | 0.00 MMBtu/hr                 |  | 0.00 MMBtu/hr                |  | 0.00 MMBtu/hr                |  | 0.00 MMBtu/hr                |  |
| Total Heat Bal. 0 MMBtu/hr            |  |  | -11.71 MMBtu/hr          |  | -8.47 MMBtu/hr            |  | -1.66 MMBtu/hr                 |            |  | 0.51 MMBtu/hr                 |  | 0.00 MMBtu/hr                |  | 0.00 MMBtu/hr                  |  | 0.00 MMBtu/hr                 |  | 0.00 MMBtu/hr                |  | 0.00 MMBtu/hr                |  | 0.00 MMBtu/hr                |  |
| Unit Aux. Fuel Bal. 0 MMBtu/hr        |  |  | 0.00 MMBtu/hr            |  | 0.00 MMBtu/hr             |  | 0.00 MMBtu/hr                  |            |  | 0.00 MMBtu/hr                 |  | 0.00 MMBtu/hr                |  | 0.00 MMBtu/hr                  |  | 0.00 MMBtu/hr                 |  | 0.00 MMBtu/hr                |  | 0.00 MMBtu/hr                |  | 0.00 MMBtu/hr                |  |
| Cum. Aux. Fuel Bal. 0 MMBtu/hr        |  |  | 0.00 MMBtu/hr            |  | 0.00 MMBtu/hr             |  | 0.00 MMBtu/hr                  |            |  | 0.00 MMBtu/hr                 |  | 0.00 MMBtu/hr                |  | 0.00 MMBtu/hr                  |  | 0.00 MMBtu/hr                 |  | 0.00 MMBtu/hr                |  | 0.00 MMBtu/hr                |  | 0.00 MMBtu/hr                |  |
| Unit Process Fuel Bal. 0 MMBtu/hr     |  |  | 43.53 MMBtu/hr           |  | 0.00 MMBtu/hr             |  | -18.93 MMBtu/hr                |            |  | -2.55 MMBtu/hr                |  | -22.05 MMBtu/hr              |  | 0.00 MMBtu/hr                  |  | 0.00 MMBtu/hr                 |  | 0.00 MMBtu/hr                |  | 0.00 MMBtu/hr                |  | 0.00 MMBtu/hr                |  |
| Cum Unit Process Fuel Bal. 0 MMBtu/hr |  |  | 43.53 MMBtu/hr           |  | 43.53 MMBtu/hr            |  | 24.59 MMBtu/hr                 |            |  | 22.05 MMBtu/hr                |  | 0.00 MMBtu/hr                |  | 0.00 MMBtu/hr                  |  | 0.00 MMBtu/hr                 |  | 0.00 MMBtu/hr                |  | 0.00 MMBtu/hr                |  | 0.00 MMBtu/hr                |  |
| Generated Steam 0 lb/hr               |  |  | 0 lb/hr                  |  | 0 lb/hr                   |  | 0 lb/hr                        |            |  | 0 lb/hr                       |  | 0 lb/hr                      |  | 0 lb/hr                        |  | 0 lb/hr                       |  | 0 lb/hr                      |  | 0 lb/hr                      |  | 0 lb/hr                      |  |
| Power Generation 0.00 MW              |  |  | 0.00 MW                  |  | 0.00 MW                   |  | 1.89 MW                        |            |  | 0.00 MW                       |  | 0.00 MW                      |  | 0.00 MW                        |  | 0.00 MW                       |  | 0.00 MW                      |  | 0.00 MW                      |  | 0.00 MW                      |  |
| No of Trucks Required 0.00 trucks/day |  |  | 0.00 trucks/day          |  | 0.00 trucks/day           |  | 0.00 trucks/day                |            |  | 0.00 trucks/day               |  | 0.00 trucks/day              |  | 6.00 trucks/day                |  | 0.00 trucks/day               |  | 0.00 trucks/day              |  | 0.00 trucks/day              |  | 11.00 trucks/day             |  |
| Vehicle Fuel Consumption 0 gal/day    |  |  | 0 gal/day                |  | 0 gal/day                 |  | 0 gal/day                      |            |  | 0 gal/day                     |  | 0 gal/day                    |  | 0 gal/day                      |  | 0 gal/day                     |  | 0 gal/day                    |  | 0 gal/day                    |  | 0 gal/day                    |  |
| Digester Gas Produced 0 scfm          |  |  | 1295 scfm                |  | 0 scfm                    |  | 0 scfm                         |            |  | 0 scfm                        |  | 0 scfm                       |  | 0 scfm                         |  | 0 scfm                        |  | 0 scfm                       |  | 0 scfm                       |  | 0 scfm                       |  |
| Methane Production 0 scfm             |  |  | 777 scfm                 |  | 0 scfm                    |  | 0 scfm                         |            |  | 0 scfm                        |  | 0 scfm                       |  | 0 scfm                         |  | 0 scfm                        |  | 0 scfm                       |  | 0 scfm                       |  | 0 scfm                       |  |
| Methane Utilized 0 scfm               |  |  | 0 scfm                   |  | 0 scfm                    |  | -338 scfm                      |            |  | -45 scfm                      |  | -394 scfm                    |  | 0 scfm                         |  | 0 scfm                        |  | 0 scfm                       |  | 0 scfm                       |  | 0 scfm                       |  |
| Scrubbed Gas 0 scfm                   |  |  | 0 scfm                   |  | 0 scfm                    |  | 0 scfm                         |            |  | 0 scfm                        |  | 0 scfm                       |  | 0 scfm                         |  | 0 scfm                        |  | 0 scfm                       |  | 0 scfm                       |  | 0 scfm                       |  |
| Unit Polymer Use 0 lb/day             |  |  | 0 lb/day                 |  | 0 lb/day                  |  | 0 lb/day                       |            |  | 0 lb/day                      |  | 1522 lb/day                  |  | 0 lb/day                       |  | 0 lb/day                      |  | 0 lb/day                     |  | 0 lb/day                     |  | 0 lb/day                     |  |

South Plant

| Feedstock   | Stabilization  |   |   |  | Gas Utilization   |   |   |  | Dewatering  | End Use  |  |
|---|--|---|---|--|---|---|---|--|---|--|--|
| <p>263760 PPD<br/>6.2%<br/>85.88%<br/>62.0%<br/>10,000 Btu/lb VS</p> <p>Feedstock Type<br/>PS + WAS</p> <p>Energy Consumption<br/>0 hp/unit<br/>90% Efficiency</p>   | <p>Pre-dewatering</p> <p>98% Capture<br/>17% TS</p> <p>Energy Consumption<br/>150 hp<br/>90% Efficiency</p> <p>Duty No. 4<br/>Polymer Use 15 lbs/DT</p>   | <p>Dilution water</p> <p>lb/day 0</p> <p>Energy Consumption<br/>0 hp<br/>90% Efficiency</p>    | <p>Thermal Hydrolysis</p> <p>Sludge Inlet Temp 65 F<br/>Operation Temp 302 F</p> <p>11.49 MMBtu/hr<br/>Energy Consumption 100 hp<br/>100% Efficiency<br/>Shell Heat Loss 5%</p> <p>Duty No. 3</p>   | <p>Dilution water</p> <p>lb/day 1305479</p> <p>Energy Consumption<br/>0 hp<br/>90% Efficiency</p>   | <p>Digester (Meso)</p> <p>VSR 62.0%</p> <p>Sludge Inlet Temp 65 F<br/>Operation Temp 98 F<br/>550 Btu/lcf<br/>16.24 cflb VS<br/>0.00 MMBtu/hr</p> <p>11.49 MMBtu/hr<br/>Energy Consumption 40 hp<br/>100% Efficiency<br/>Shell Heat Loss 15%</p> <p>Duty No. 4</p>   | <p>CHP Engine</p> <p>909 NG LHV</p> <p>Therm Eff. 38%</p> <p>Nat gas usage, cfm 0<br/>Biogas Fuel use 0%</p> <p>Engine Electrical Eff. 30%<br/>Heat Recovery 0.00 MMBtu/hr</p> <p>Energy Consumption 145 hp/unit<br/>90% Efficiency</p> <p>Duty No. 0</p>                    | <p>Boiler</p> <p>909 NG LHV</p> <p>Therm Eff. 85%</p> <p>Nat gas usage, cfm 15,611<br/>Biogas Fuel use 0%</p> <p>Heat Recovery 12.06 MMBtu/hr</p> <p>Energy Consumption 40 hp/unit<br/>90% Efficiency</p> <p>Duty No. 2</p>    | <p>Biogas Upgrading</p> <p>Nat gas usage, cfm 0<br/>Biogas Fuel use 85%</p> <p>Energy Consumption 747 hp/unit<br/>100% Efficiency</p> <p>Duty No. 1</p>   | <p>Flare</p> <p>Energy Consumption 0 hp/unit<br/>90% Efficiency</p> <p>Duty No. 2</p>    | <p>Centrifuge</p> <p>95% Capture<br/>30% TS</p> <p>Energy Consumption 225 hp/unit<br/>90% Efficiency</p> <p>Duty No. 4<br/>Polymer Use 35 lbs/DT</p>  | <p>114755 PPD<br/>100% Land Application<br/>30.0%<br/>70%</p> <p>End Use<br/>Land Application</p> <p>Energy Consumption<br/>0 hp/unit<br/>90% Efficiency</p>  |
| <p>177,258 lb/hr<br/>10,990 lb/hr<br/>131.9 DTPD<br/>9,439 lb/hr<br/>166,268 lb/hr<br/>6.20%<br/>86%<br/>5,852 lb/hr<br/>354.2 gpm<br/>10,000 Btu/lb VS<br/>0.0 kW<br/>0 MMBtu/hr<br/>0 MMBtu/hr<br/>0 MMBtu/hr<br/>0 MMBtu/hr<br/>0 MMBtu/hr<br/>0 MMBtu/hr<br/>0 lb/hr<br/>0 MW</p> <p>0.00 trucks/day<br/>0 gal/day<br/>0 scfm<br/>0 scfm<br/>0 scfm<br/>0 scfm<br/>0 lb/day</p> | <p>65,274 lb/hr<br/>10,770 lb/hr<br/>129.2 DTPD<br/>9,250 lb/hr<br/>54,504 lb/hr<br/>16.50%<br/>86%<br/>5,735 lb/hr<br/>130.4 gpm<br/>10,000 Btu/lb VS<br/>497.3 kW<br/>0.00 MMBtu/hr<br/>0.00 MMBtu/hr<br/>0.00 MMBtu/hr<br/>0.00 MMBtu/hr<br/>0.00 MMBtu/hr<br/>0.00 MMBtu/hr<br/>0 lb/hr<br/>0.00 MW</p> <p>0.00 trucks/day<br/>0 gal/day<br/>0 scfm<br/>0 scfm<br/>0 scfm<br/>0 scfm<br/>1978 lb/day</p> | <p>65,274 lb/hr<br/>10,770 lb/hr<br/>129.2 DTPD<br/>9,250 lb/hr<br/>54,504 lb/hr<br/>16.50%<br/>86%<br/>5,735 lb/hr<br/>130.4 gpm<br/>10,000 Btu/lb VS<br/>0.0 kW<br/>0.00 MMBtu/hr<br/>0.00 MMBtu/hr<br/>0.00 MMBtu/hr<br/>0.00 MMBtu/hr<br/>0.00 MMBtu/hr<br/>0.00 MMBtu/hr<br/>0 lb/hr<br/>0.00 MW</p> <p>0.00 trucks/day<br/>0 gal/day<br/>0 scfm<br/>0 scfm<br/>0 scfm<br/>0 scfm<br/>0 lb/day</p> | <p>65,274 lb/hr<br/>10,770 lb/hr<br/>129.2 DTPD<br/>9,250 lb/hr<br/>54,504 lb/hr<br/>16.50%<br/>86%<br/>5,735 lb/hr<br/>130.4 gpm<br/>10,000 Btu/lb VS<br/>223.8 kW<br/>-12.07 MMBtu/hr<br/>0.00 MMBtu/hr<br/>0.00 MMBtu/hr<br/>0.00 MMBtu/hr<br/>0.00 MMBtu/hr<br/>0.00 MMBtu/hr<br/>0 lb/hr<br/>0.00 MW</p> <p>0.00 trucks/day<br/>0 gal/day<br/>0 scfm<br/>0 scfm<br/>0 scfm<br/>0 scfm<br/>0 lb/day</p> | <p>119,669 lb/hr<br/>10,770 lb/hr<br/>129.2 DTPD<br/>9,250 lb/hr<br/>108,899 lb/hr<br/>9.00%<br/>86%<br/>5,735 lb/hr<br/>239.1 gpm<br/>10,000 Btu/lb VS<br/>0.0 kW<br/>0.00 MMBtu/hr<br/>-12.07 MMBtu/hr<br/>0.00 MMBtu/hr<br/>0.00 MMBtu/hr<br/>0.00 MMBtu/hr<br/>0.00 MMBtu/hr<br/>0 lb/hr<br/>0.00 MW</p> <p>0.00 trucks/day<br/>0 gal/day<br/>0 scfm<br/>0 scfm<br/>0 scfm<br/>0 scfm<br/>0 lb/day</p> | <p>113,934 lb/hr<br/>5,035 lb/hr<br/>60.4 DTPD<br/>3,515 lb/hr<br/>108,899 lb/hr<br/>4.42%<br/>70%<br/>0 lb/hr<br/>227.7 gpm<br/>10,000 Btu/lb VS<br/>119.4 kW<br/>0.00 MMBtu/hr<br/>-12.06 MMBtu/hr<br/>0.00 MMBtu/hr<br/>0.00 MMBtu/hr<br/>0.00 MMBtu/hr<br/>51.22 MMBtu/hr<br/>51.22 MMBtu/hr<br/>0 lb/hr<br/>0.00 MW</p> <p>0.00 trucks/day<br/>0 gal/day<br/>1552 scfm<br/>931 scfm<br/>0 scfm<br/>0 scfm<br/>0 lb/day</p> | <p>113,934 lb/hr<br/>5,035 lb/hr<br/>60.4 DTPD<br/>3,515 lb/hr<br/>108,899 lb/hr<br/>4.42%<br/>70%<br/>0 lb/hr<br/>227.7 gpm<br/>10,000 Btu/lb VS<br/>0.0 kW<br/>12.06 MMBtu/hr<br/>14.19 MMBtu/hr<br/>0.00 MMBtu/hr<br/>51.22 MMBtu/hr<br/>0 lb/hr<br/>0.00 MW</p> <p>0.00 trucks/day<br/>0 gal/day<br/>0 scfm<br/>0 scfm<br/>0 scfm<br/>0 scfm<br/>0 lb/day</p> | <p>113,934 lb/hr<br/>5,035 lb/hr<br/>60.4 DTPD<br/>3,515 lb/hr<br/>108,899 lb/hr<br/>4.42%<br/>70%<br/>0 lb/hr<br/>227.7 gpm<br/>10,000 Btu/lb VS<br/>66.3 kW<br/>-12.06 MMBtu/hr<br/>14.19 MMBtu/hr<br/>0.00 MMBtu/hr<br/>51.22 MMBtu/hr<br/>0 lb/hr<br/>0.00 MW</p> <p>0.00 trucks/day<br/>0 gal/day<br/>0 scfm<br/>0 scfm<br/>0 scfm<br/>0 scfm<br/>0 lb/day</p> | <p>113,934 lb/hr<br/>5,035 lb/hr<br/>60.4 DTPD<br/>3,515 lb/hr<br/>108,899 lb/hr<br/>4.42%<br/>70%<br/>0 lb/hr<br/>227.7 gpm<br/>10,000 Btu/lb VS<br/>557.1 kW<br/>0.00 MMBtu/hr<br/>0.00 MMBtu/hr<br/>0.00 MMBtu/hr<br/>14.19 MMBtu/hr<br/>-43.29 MMBtu/hr<br/>7.94 MMBtu/hr<br/>0.00 MMBtu/hr<br/>0 lb/hr<br/>0.00 MW</p> <p>0.00 trucks/day<br/>0 gal/day<br/>0 scfm<br/>0 scfm<br/>-787 scfm<br/>708 scfm<br/>0 lb/day</p> | <p>15,938 lb/hr<br/>4,781 lb/hr<br/>57.4 DTPD<br/>3,338 lb/hr<br/>11,157 lb/hr<br/>30.00%<br/>70%<br/>0 lb/hr<br/>31.9 gpm<br/>10,000 Btu/lb VS<br/>746.0 kW<br/>0.00 MMBtu/hr<br/>0.00 MMBtu/hr<br/>0.00 MMBtu/hr<br/>14.19 MMBtu/hr<br/>0.00 MMBtu/hr<br/>0.00 MMBtu/hr<br/>0 lb/hr<br/>0.00 MW</p> <p>7.00 trucks/day<br/>0 gal/day<br/>0 scfm<br/>0 scfm<br/>0 scfm<br/>0 scfm<br/>0 lb/day</p> |  |  |



**Brightwater**

**Off-site Composting**

| Feedstock  |  | Stabilization   | Gas Utilization  |   | Dewatering  | End Use   | Feedstock   | Feedstock   | Feedstock   | Stabilization  | End Use  |
|--|--|---|--|---|---|---|---|---|---|--|--|
| 93910 PPD<br>5.8%<br>90%<br>61%<br>10,000 Btu/lb VS  |  | Digester (Meso)   | Boiler   | Flare   | Centrifuge  | 100% Land Application<br>39295 PPD<br>20.0%<br>78%  | 39295 PPD<br>20.0%<br>77.61%<br>15.0%<br>10,000 Btu/lb VS   | 132465 PPD<br>55.0%<br>95.00%<br>15.0%<br>10,000 Btu/lb VS  | 16611 PPD<br>55.0%<br>89.68%<br>15.0%<br>10,000 Btu/lb VS   | Compost  | 162685 PPD<br>50.0%<br>89%   |
| Feedstock Type<br>PS + WAS   |  | VSR 60.9%   | 909 NG LHV<br>Therm Eff. 85%<br>Nat gas usage, cfh 0<br>Biogas Fuel use 70%  |   | 93% Capture<br>20% TS   | End Use<br>Land Application   | Feedstock Type<br>Dewatered Cake  | Feedstock Type<br>Virgin Woodchips  | Feedstock Type<br>Screened Overs  | 50% VSR<br>15.0% TS  | End Use<br>Local Retail  |
| Sludge Inlet Temp 65 F<br>Operation Temp 98 F<br>550 Btu/cf<br>16 cf/lb VS<br>2.23 MMBtu/hr  |  | Heat Recovery 11.22 MMBtu/hr  |  |   |   |   |   |   |   |  |  |
| Energy Consumption 0 hp/unit<br>90% Efficiency   |  | Energy Consumption 40 hp/unit<br>100% Efficiency<br>Shell Heat Loss 15%   | Energy Consumption 40 hp/unit<br>90% Efficiency  | Energy Consumption 0 hp/unit<br>90% Efficiency  | Energy Consumption 200 hp/unit<br>90% Efficiency  | Energy Consumption 0 hp/unit<br>90% Efficiency  | Energy Consumption 0 hp/unit<br>90% Efficiency  | Energy Consumption 0 hp/unit<br>90% Efficiency  | Energy Consumption 0 hp/unit<br>90% Efficiency  | Energy Consumption 260 hp<br>90% Efficiency  | Energy Consumption 0 hp/unit<br>90% Efficiency   |
|  |  | Duty No. 3  | Duty No. 1   | Duty No. 1  | Duty No. 2<br>Polymer Use 35 lbs/DT   |   |   |   |   | Duty No. 1   |  |
|  |  |   |  |   |   |   |   |   |   |  |  |
| 67,464 lb/hr<br>3,913 lb/hr<br>47.0 DTPD<br>3,517 lb/hr<br>63,551 lb/hr<br>5.80%<br>90%<br>2,143 lb/hr<br>134.8 gpm<br>10,000 Btu/lb VS<br>0 kW<br>0 MMBtu/hr<br>0 MMBtu/hr<br>0 MMBtu/hr<br>0 MMBtu/hr<br>0 MMBtu/hr<br>0 lb/hr<br>0 MW<br>0.00 trucks/day<br>0 gal/day<br>0 scfm<br>0 scfm<br>0 scfm<br>0 scfm<br>0 lb/day |  | 65,321 lb/hr<br>1,770 lb/hr<br>21.2 DTPD<br>1,374 lb/hr<br>63,551 lb/hr<br>2.71%<br>78%<br>0 lb/hr<br>130.5 gpm<br>10,000 Btu/lb VS<br>89.5 kW<br>-2.56 MMBtu/hr<br>0.00 MMBtu/hr<br>0.00 MMBtu/hr<br>0.00 MMBtu/hr<br>18.86 MMBtu/hr<br>18.86 MMBtu/hr<br>0 lb/hr<br>0.00 MW<br>0.00 trucks/day<br>0 gal/day<br>571 scfm<br>343 scfm<br>0 scfm<br>0 scfm<br>0 lb/day | 65,321 lb/hr<br>1,770 lb/hr<br>21.2 DTPD<br>1,374 lb/hr<br>63,551 lb/hr<br>2.71%<br>78%<br>0 lb/hr<br>130.5 gpm<br>10,000 Btu/lb VS<br>33.2 kW<br>11.22 MMBtu/hr<br>8.66 MMBtu/hr<br>0.00 MMBtu/hr<br>0.00 MMBtu/hr<br>-13.20 MMBtu/hr<br>5.66 MMBtu/hr<br>0 lb/hr<br>0.00 MW<br>0.00 trucks/day<br>0 gal/day<br>0 scfm<br>0 scfm<br>-240 scfm<br>0 scfm<br>0 lb/day | 65,321 lb/hr<br>1,770 lb/hr<br>21.2 DTPD<br>1,374 lb/hr<br>63,551 lb/hr<br>2.71%<br>78%<br>0 lb/hr<br>130.5 gpm<br>10,000 Btu/lb VS<br>0.0 kW<br>0.00 MMBtu/hr<br>8.66 MMBtu/hr<br>0.00 MMBtu/hr<br>0.00 MMBtu/hr<br>-5.66 MMBtu/hr<br>0.00 MMBtu/hr<br>0 lb/hr<br>0.00 MW<br>0.00 trucks/day<br>0 gal/day<br>0 scfm<br>-103 scfm<br>0 scfm<br>0 lb/day | 8,186 lb/hr<br>1,637 lb/hr<br>19.6 DTPD<br>1,271 lb/hr<br>6,549 lb/hr<br>20.00%<br>78%<br>0 lb/hr<br>16.4 gpm<br>10,000 Btu/lb VS<br>331.6 kW<br>0.00 MMBtu/hr<br>8.66 MMBtu/hr<br>0.00 MMBtu/hr<br>0.00 MMBtu/hr<br>0.00 MMBtu/hr<br>0.00 MMBtu/hr<br>0 lb/hr<br>0.00 MW<br>4.00 trucks/day<br>0 gal/day<br>0 scfm<br>0 scfm<br>0 scfm<br>0 scfm<br>0 lb/day | 8,186 lb/hr<br>1,637 lb/hr<br>19.6 DTPD<br>1,271 lb/hr<br>6,549 lb/hr<br>20.00%<br>78%<br>0 lb/hr<br>16.4 gpm<br>10,000 Btu/lb VS<br>0.0 kW<br>0.00 MMBtu/hr<br>8.66 MMBtu/hr<br>0.00 MMBtu/hr<br>0.00 MMBtu/hr<br>0.00 MMBtu/hr<br>0.00 MMBtu/hr<br>0 lb/hr<br>0.00 MW<br>4.00 trucks/day<br>0 gal/day<br>0 scfm<br>0 scfm<br>0 scfm<br>0 scfm<br>0 lb/day | 8,186 lb/hr<br>1,637 lb/hr<br>19.6 DTPD<br>1,271 lb/hr<br>6,549 lb/hr<br>20.00%<br>78%<br>191 lb/hr<br>16.4 gpm<br>10,000 Btu/lb VS<br>0.0 kW<br>0.00 MMBtu/hr<br>0.00 MMBtu/hr<br>0.00 MMBtu/hr<br>0.00 MMBtu/hr<br>0.00 MMBtu/hr<br>0.00 MMBtu/hr<br>0 lb/hr<br>0.00 MW<br>0.00 trucks/day<br>0 gal/day<br>0 scfm<br>0 scfm<br>0 scfm<br>0 scfm<br>0 lb/day | 18,222 lb/hr<br>7,157 lb/hr<br>85.9 DTPD<br>6,514 lb/hr<br>11,065 lb/hr<br>39.28%<br>91%<br>977 lb/hr<br>36.4 gpm<br>10,000 Btu/lb VS<br>0.0 kW<br>0.00 MMBtu/hr<br>0.00 MMBtu/hr<br>0.00 MMBtu/hr<br>0.00 MMBtu/hr<br>0.00 MMBtu/hr<br>0.00 MMBtu/hr<br>0 lb/hr<br>0.00 MW<br>0.00 trucks/day<br>0 gal/day<br>0 scfm<br>0 scfm<br>0 scfm<br>0 scfm<br>0 lb/day | 19,480 lb/hr<br>7,849 lb/hr<br>94.2 DTPD<br>7,135 lb/hr<br>11,631 lb/hr<br>40.29%<br>91%<br>1,070 lb/hr<br>38.9 gpm<br>10,000 Btu/lb VS<br>0.0 kW<br>0.00 MMBtu/hr<br>0.00 MMBtu/hr<br>0.00 MMBtu/hr<br>0.00 MMBtu/hr<br>0.00 MMBtu/hr<br>0.00 MMBtu/hr<br>0 lb/hr<br>0.00 MW<br>0.00 trucks/day<br>0 gal/day<br>0 scfm<br>0 scfm<br>0 scfm<br>0 scfm<br>0 lb/day | 13,557 lb/hr<br>6,779 lb/hr<br>81.3 DTPD<br>6,065 lb/hr<br>6,779 lb/hr<br>50.00%<br>89%<br>0 lb/hr<br>27.1 gpm<br>10,000 Btu/lb VS<br>215.5 kW<br>0.00 MMBtu/hr<br>0.00 MMBtu/hr<br>0.00 MMBtu/hr<br>0.00 MMBtu/hr<br>0.00 MMBtu/hr<br>0.00 MMBtu/hr<br>0 lb/hr<br>0.00 MW<br>0.00 trucks/day<br>0 gal/day<br>0 scfm<br>0 scfm<br>0 scfm<br>0 scfm<br>0 lb/day | 13,557 lb/hr<br>6,779 lb/hr<br>81.3 DTPD<br>6,065 lb/hr<br>6,779 lb/hr<br>50.00%<br>89%<br>0 lb/hr<br>27.1 gpm<br>10,000 Btu/lb VS<br>0.0 kW<br>0.00 MMBtu/hr<br>0.00 MMBtu/hr<br>0.00 MMBtu/hr<br>0.00 MMBtu/hr<br>0.00 MMBtu/hr<br>0.00 MMBtu/hr<br>0 lb/hr<br>0.00 MW<br>6.00 trucks/day<br>0 gal/day<br>0 scfm<br>0 scfm<br>0 scfm<br>0 scfm<br>0 lb/day |









| S3 Output Summary                   |       |
|-------------------------------------|-------|
| Final TS, Wet (WT/D)                | 0     |
| NG Req. (cfh)                       | 42506 |
| NG (LHV MMBtu/h)                    | 39    |
| Net heat (MMBtu/h)                  | 11    |
| Electricity Req. (kWh)              | 8441  |
| Power Generation (kWh)              | 1760  |
| Net Power (kWh)                     | -6681 |
| No. of Trucks Required (trucks/day) | 22    |
| Digester Gas Produced (scfm)**      | 3325  |
| Methane Produced (scfm)**           | 1995  |
| Scrubbed Gas (scfm)**               | 700   |
| Polymer Use (lb/day)                | 4611  |

Scenario 3 - MAD at all three plants with off-site Thermal Drying and Pyrolysis







West Point

| Feedstock   | Stabilization  | Gas Utilization   |  |  | Dewatering   | End Use   |
|---|--|---|--|--|--|---|
| Dry Mass Flow 225860 PPD<br>TS 6.1%<br>VS 81%<br>VSR 64%<br>Calorific Value 10,000 Btu/lb VS<br>Feedstock Type PS + WAS<br>Energy Consumption 0 hp<br>90% Efficiency  | Digester (Meso)<br>VSR 64.0%<br>Sludge Inlet Temp 65 F<br>Operation Temp 98 F<br>555 Btu/cf<br>15 cftb VS<br>5.09 MMBtu/hr<br>Energy Consumption 40 hpl/unit<br>100% Efficiency<br>Shell Heat Loss 15%<br>Duty No. 5   | CHP Engine<br>909 NG LHV<br>Therm. Eff. 36%<br>Nat gas usage, cfh 0<br>Biogas Fuel use 44%<br>Engine Electrical Eff. 34%<br>Heat Recovery 6.36 MMBtu/hr<br>Energy Consumption 269 hpl/unit<br>90% Efficiency<br>Duty No. 1  | Boiler<br>909 NG LHV<br>Therm. Eff. 85%<br>Nat gas usage, cfh 0<br>Biogas Fuel use 10%<br>Heat Recovery 2.02 MMBtu/hr<br>Energy Consumption 40 hpl/unit<br>90% Efficiency<br>Duty No. 2  | Flare<br>Energy Consumption 0 hpl/unit<br>90% Efficiency<br>Duty No. 2   | Centrifuge<br>92% Capture<br>29% TS<br>Energy Consumption 225 hpl/unit<br>90% Efficiency<br>Duty No. 4<br>Polymer Use 30 lbs/DT  | 100% Off-site Processing<br>PPD<br>100295<br>28.5%<br>61%<br>End Use Off-site Processing<br>Energy Consumption 0 hpl/unit<br>90% Efficiency<br>Duty No. 6<br>Polymer Use 0 lbs/DT   |
| Wet Mass Flow 154,276 lb/hr<br>Dry Mass Flow 9,411 lb/hr<br>VS 7,620 lb/hr<br>Water 144,865 lb/hr<br>TS 6.10%<br>VS 81%<br>VSR 4,878 lb/hr<br>Wet flow 308.3 gpm<br>Calorific Value 10,000 Btu/lb VS<br>Electrical Demand 0.0 kW<br>Unit Heat Bal. 0 MMBtu/hr<br>Total Heat Bal. 0 MMBtu/hr<br>Unit Aux. Fuel Bal. 0.00 MMBtu/hr<br>Cum. Aux. Fuel Bal. 0.00 MMBtu/hr<br>Unit Process Fuel Bal. 0.00 MMBtu/hr<br>Cum Unit Process Fuel Bal. 0.00 MMBtu/hr<br>Generated Steam 0 lb/hr<br>Power Generation 0.00 MW<br>No of Trucks Required 0.00 trucks/day<br>Vehicle Fuel Consumption 0 gal/day<br>Digester Gas Production 0 scfm<br>Methane Production 0 scfm<br>Methane Utilized 0 scfm<br>Scrubbed Gas 0 scfm<br>Unit Polymer Use 0 lb/day | 149,398 lb/hr<br>4,533 lb/hr<br>54.4 DTPD<br>2,743 lb/hr<br>144,865 lb/hr<br>3.03%<br>61%<br>0 lb/hr<br>298.6 gpm<br>10,000 Btu/lb VS<br>149.2 kW<br>-5.85 MMBtu/hr<br>-5.85 MMBtu/hr<br>0.00 MMBtu/hr<br>0.00 MMBtu/hr<br>40.61 MMBtu/hr<br>40.61 MMBtu/hr<br>0 lb/hr<br>0.00 MW<br>0.00 trucks/day<br>0 gal/day<br>1219 scfm<br>732 scfm<br>0 scfm<br>0 scfm<br>0 lb/day | 149,398 lb/hr<br>4,533 lb/hr<br>54.4 DTPD<br>2,743 lb/hr<br>144,865 lb/hr<br>3.03%<br>61%<br>0 lb/hr<br>298.6 gpm<br>10,000 Btu/lb VS<br>239.7 kW<br>6.36 MMBtu/hr<br>0.50 MMBtu/hr<br>0.00 MMBtu/hr<br>0.00 MMBtu/hr<br>-17.66 MMBtu/hr<br>22.94 MMBtu/hr<br>0 lb/hr<br>1.76 MW<br>0.00 trucks/day<br>0 gal/day<br>0 scfm<br>0 scfm<br>-318 scfm<br>0 scfm<br>0 lb/day | 149,398 lb/hr<br>4,533 lb/hr<br>54.4 DTPD<br>2,743 lb/hr<br>144,865 lb/hr<br>3.03%<br>61%<br>0 lb/hr<br>298.6 gpm<br>10,000 Btu/lb VS<br>66.3 kW<br>2.02 MMBtu/hr<br>2.52 MMBtu/hr<br>0.00 MMBtu/hr<br>0.00 MMBtu/hr<br>-2.38 MMBtu/hr<br>20.57 MMBtu/hr<br>0 lb/hr<br>0.00 MW<br>0.00 trucks/day<br>0 gal/day<br>0 scfm<br>0 scfm<br>-43 scfm<br>0 scfm<br>0 lb/day | 149,398 lb/hr<br>4,533 lb/hr<br>54.4 DTPD<br>2,743 lb/hr<br>144,865 lb/hr<br>3.03%<br>61%<br>0 lb/hr<br>298.6 gpm<br>10,000 Btu/lb VS<br>0.0 kW<br>2.52 MMBtu/hr<br>2.52 MMBtu/hr<br>0.00 MMBtu/hr<br>0.00 MMBtu/hr<br>-20.57 MMBtu/hr<br>0.00 MMBtu/hr<br>0 lb/hr<br>0.00 MW<br>0.00 trucks/day<br>0 gal/day<br>0 scfm<br>0 scfm<br>-371 scfm<br>0 scfm<br>0 lb/day | 14,663 lb/hr<br>4,179 lb/hr<br>50.1 DTPD<br>2,528 lb/hr<br>10,484 lb/hr<br>28.50%<br>61%<br>0 lb/hr<br>29.3 gpm<br>10,000 Btu/lb VS<br>746.0 kW<br>0.00 MMBtu/hr<br>2.52 MMBtu/hr<br>0.00 MMBtu/hr<br>0.00 MMBtu/hr<br>0.00 MMBtu/hr<br>0.00 MMBtu/hr<br>0 lb/hr<br>0.00 MW<br>0.00 trucks/day<br>0 gal/day<br>0 scfm<br>0 scfm<br>0 scfm<br>0 scfm<br>1632 lb/day | 14,663 lb/hr<br>4,179 lb/hr<br>50.1 DTPD<br>2,528 lb/hr<br>10,484 lb/hr<br>28.50%<br>61%<br>0 lb/hr<br>29.3 gpm<br>10,000 Btu/lb VS<br>0.0 kW<br>0.00 MMBtu/hr<br>2.52 MMBtu/hr<br>0.00 MMBtu/hr<br>0.00 MMBtu/hr<br>0.00 MMBtu/hr<br>0.00 MMBtu/hr<br>0 lb/hr<br>0.00 MW<br>6.00 trucks/day<br>0 gal/day<br>0 scfm<br>0 scfm<br>0 scfm<br>0 scfm<br>0 lb/day |





**South Plant**

| Feedstock  | Stabilization   | Gas Utilization   |  |  |   | Dewatering   | End Use   |
|--|---|---|--|--|---|--|---|
| <p>263760 PPD<br/>6.2%<br/>85.88%<br/>60.0%<br/>10,000 Btu/lb VS</p> <p>Feedstock Type<br/>PS + WAS</p> <p>Energy Consumption<br/>0 hpl/unit<br/>90% Efficiency</p>   | <p>Digester (Meso)</p> <p>VSR 60.0%</p> <p>Sludge Inlet Temp F<br/>65</p> <p>Operation Temp F<br/>98</p> <p>550 Btu/cf<br/>16.24 cf/lb VS<br/>5.85 MMBtu/hr</p> <p>Energy Consumption<br/>40 hpl/unit<br/>100% Efficiency</p> <p>Shell Heat Loss<br/>15%</p> <p>Duty No. 4</p>   | <p>CHP Engine 909<br/>NG LHV</p> <p>Therm Eff. 38%</p> <p>Net gas usage, cfm<br/>0</p> <p>Biogas Fuel use 0%</p> <p>Engine Electrical Eff. 30%</p> <p>Heat Recovery<br/>0.00 MMBtu/hr</p> <p>Energy Consumption<br/>145 hpl/unit<br/>90% Efficiency</p> <p>Duty No. 0</p>    | <p>Boiler 909<br/>NG LHV</p> <p>Therm Eff. 85%</p> <p>Net gas usage, cfm<br/>8,705</p> <p>Biogas Fuel use 0%</p> <p>Heat Recovery<br/>6.73 MMBtu/hr</p> <p>Energy Consumption<br/>40 hpl/unit<br/>90% Efficiency</p> <p>Duty No. 2</p>    | <p>Biogas Upgrading</p> <p>Net gas usage, cfm<br/>0</p> <p>Biogas Fuel use 85%</p> <p>Energy Consumption<br/>738 hpl/unit<br/>100% Efficiency</p> <p>Duty No. 1</p>   | <p>Flare</p> <p>Energy Consumption<br/>0 hpl/unit<br/>90% Efficiency</p> <p>Duty No. 2</p>    | <p>Centrifuge</p> <p>95% Capture<br/>23% TS</p> <p>Energy Consumption<br/>225 hpl/unit<br/>90% Efficiency</p> <p>Duty No. 4</p> <p>Polymer Use<br/>35 lbs/DT</p>    | <p>121334 PPD<br/>22.9%<br/>71%</p> <p>End Use<br/>Offsite Processing</p> <p>Energy Consumption<br/>0 hpl/unit<br/>90% Efficiency</p>  |
| <p>177,258 lb/hr<br/>10,990 lb/hr<br/>131.9 DTPD<br/>9,439 lb/hr<br/>166,268 lb/hr<br/>6.20%<br/>86%<br/>5,666 lb/hr<br/>354.2 gpm<br/>10,000 Btu/lb VS<br/>0.0 kW<br/>0 MMBtu/hr<br/>0 MMBtu/hr<br/>0 MMBtu/hr<br/>0 MMBtu/hr<br/>0 MMBtu/hr<br/>0 MMBtu/hr<br/>0 MMBtu/hr<br/>0 lb/hr<br/>0 MW</p> <p>0.00 trucks/day<br/>0 gal/day<br/>0 scfm<br/>920 scfm<br/>0 scfm<br/>0 scfm<br/>0 lb/day</p> | <p>171,592 lb/hr<br/>5,324 lb/hr<br/>63.9 DTPD<br/>3,773 lb/hr<br/>166,268 lb/hr<br/>3.10%<br/>71%<br/>0 lb/hr<br/>342.9 gpm<br/>10,000 Btu/lb VS<br/>119.4 kW<br/>-6.73 MMBtu/hr<br/>0.00 MMBtu/hr<br/>-6.73 MMBtu/hr<br/>0.00 MMBtu/hr<br/>0.00 MMBtu/hr<br/>0.00 MMBtu/hr<br/>50.61 MMBtu/hr<br/>50.61 MMBtu/hr<br/>0 lb/hr<br/>0.00 MW</p> <p>0.00 trucks/day<br/>0 gal/day<br/>1534 scfm<br/>920 scfm<br/>0 scfm<br/>0 scfm<br/>0 lb/day</p> | <p>171,592 lb/hr<br/>5,324 lb/hr<br/>63.9 DTPD<br/>3,773 lb/hr<br/>166,268 lb/hr<br/>3.10%<br/>71%<br/>0 lb/hr<br/>342.9 gpm<br/>10,000 Btu/lb VS<br/>0.0 kW<br/>0.00 MMBtu/hr<br/>-6.73 MMBtu/hr<br/>0.00 MMBtu/hr<br/>0.00 MMBtu/hr<br/>0.00 MMBtu/hr<br/>0.00 MMBtu/hr<br/>50.61 MMBtu/hr<br/>50.61 MMBtu/hr<br/>0 lb/hr<br/>0.00 MW</p> <p>0.00 trucks/day<br/>0 gal/day<br/>0 scfm<br/>0 scfm<br/>0 scfm<br/>0 scfm<br/>0 lb/day</p> | <p>171,592 lb/hr<br/>5,324 lb/hr<br/>63.9 DTPD<br/>3,773 lb/hr<br/>166,268 lb/hr<br/>3.10%<br/>71%<br/>0 lb/hr<br/>342.9 gpm<br/>10,000 Btu/lb VS<br/>66.3 kW<br/>6.73 MMBtu/hr<br/>0.00 MMBtu/hr<br/>7.91 MMBtu/hr<br/>0.00 MMBtu/hr<br/>7.91 MMBtu/hr<br/>0.00 MMBtu/hr<br/>-42.76 MMBtu/hr<br/>50.61 MMBtu/hr<br/>0 lb/hr<br/>0.00 MW</p> <p>0.00 trucks/day<br/>0 gal/day<br/>0 scfm<br/>0 scfm<br/>0 scfm<br/>0 scfm<br/>0 lb/day</p> | <p>171,592 lb/hr<br/>5,324 lb/hr<br/>63.9 DTPD<br/>3,773 lb/hr<br/>166,268 lb/hr<br/>3.10%<br/>71%<br/>0 lb/hr<br/>342.9 gpm<br/>10,000 Btu/lb VS<br/>558.4 kW<br/>0.00 MMBtu/hr<br/>0.00 MMBtu/hr<br/>0.00 MMBtu/hr<br/>0.00 MMBtu/hr<br/>7.91 MMBtu/hr<br/>-7.84 MMBtu/hr<br/>0.00 MMBtu/hr<br/>0 lb/hr<br/>0.00 MW</p> <p>0.00 trucks/day<br/>0 gal/day<br/>0 scfm<br/>0 scfm<br/>-778 scfm<br/>700 scfm<br/>0 lb/day</p> | <p>171,592 lb/hr<br/>5,324 lb/hr<br/>63.9 DTPD<br/>3,773 lb/hr<br/>166,268 lb/hr<br/>3.10%<br/>71%<br/>0 lb/hr<br/>342.9 gpm<br/>10,000 Btu/lb VS<br/>0.0 kW<br/>0.00 MMBtu/hr<br/>0.00 MMBtu/hr<br/>0.00 MMBtu/hr<br/>7.91 MMBtu/hr<br/>0.00 MMBtu/hr<br/>0.00 MMBtu/hr<br/>0 lb/hr<br/>0.00 MW</p> <p>0.00 trucks/day<br/>0 gal/day<br/>0 scfm<br/>0 scfm<br/>-143 scfm<br/>0 scfm<br/>0 lb/day</p> | <p>22,077 lb/hr<br/>5,056 lb/hr<br/>60.7 DTPD<br/>3,583 lb/hr<br/>17,021 lb/hr<br/>22.90%<br/>71%<br/>0 lb/hr<br/>44.1 gpm<br/>10,000 Btu/lb VS<br/>746.0 kW<br/>0.00 MMBtu/hr<br/>0.00 MMBtu/hr<br/>0.00 MMBtu/hr<br/>0.00 MMBtu/hr<br/>7.91 MMBtu/hr<br/>0.00 MMBtu/hr<br/>0.00 MMBtu/hr<br/>0 lb/hr<br/>0.00 MW</p> <p>9.00 trucks/day<br/>0 gal/day<br/>0 scfm<br/>0 scfm<br/>0 scfm<br/>0 scfm<br/>0 lb/day</p> |   |

**Brightwater**

| Feedstock   | Stabilization   | Gas Utilization   |  | Dewatering   | End Use  |
|---|---|---|--|--|--|
| <p>93910 PPD<br/>5.8%<br/>90%<br/>61%<br/>10,000 Btu/lb VS</p> <p>Feedstock Type<br/>PS + WAS</p> <p>Energy Consumption<br/>0 hpl/unit<br/>90% Efficiency</p>    | <p>Digester (Meso)</p> <p>VSR 60.9%</p> <p>Sludge Inlet Temp F<br/>65<br/>Operation Temp F<br/>98<br/>550 Btu/cf<br/>16 cflb VS<br/>2.23 MMBtu/hr</p> <p>Energy Consumption<br/>40 hpl/unit<br/>100% Efficiency<br/>Shell Heat Loss<br/>15%</p> <p>Duty No. 3</p>    | <p>Boiler</p> <p>909 NG LHV</p> <p>Therm Eff. 85%</p> <p>Net gas usage, cfm<br/>0<br/>70%</p> <p>Heat Recovery<br/>11.22 MMBtu/hr</p> <p>Energy Consumption<br/>40 hpl/unit<br/>90% Efficiency</p> <p>Duty No. 1</p>   | <p>Flare</p> <p>Energy Consumption<br/>0 hpl/unit<br/>90% Efficiency</p> <p>Duty No. 1</p>    | <p>Centrifuge</p> <p>93% Capture<br/>20% TS</p> <p>Energy Consumption<br/>200 hpl/unit<br/>90% Efficiency</p> <p>Duty No. 2<br/>Polymer Use<br/>35 lbs/DT</p>    | <p>39295 PPD<br/>100% Off-Site Processing<br/>20.0%<br/>78%</p> <p>End Use<br/>Off-Site Processing</p> <p>Energy Consumption<br/>0 hpl/unit<br/>90% Efficiency</p>    |
| <p>67,464 lb/hr<br/>3,913 lb/hr<br/>47.0 DTPD<br/>3,517 lb/hr<br/>63,551 lb/hr<br/>5.80%<br/>90%<br/>2,143 lb/hr<br/>134.8 gpm<br/>10,000 Btu/lb VS<br/>0 kW<br/>0 MMBtu/hr<br/>0 MMBtu/hr<br/>0 MMBtu/hr<br/>0 MMBtu/hr<br/>0 MMBtu/hr<br/>0 MMBtu/hr<br/>0 MMBtu/hr<br/>0 lb/hr<br/>0 MW<br/>0.00 trucks/day<br/>0 gal/day<br/>0 scfm<br/>0 scfm<br/>0 scfm<br/>0 scfm<br/>0 lb/day</p> | <p>65,321 lb/hr<br/>1,770 lb/hr<br/>21.2 DTPD<br/>1,374 lb/hr<br/>63,551 lb/hr<br/>2.71%<br/>78%<br/>0 lb/hr<br/>130.5 gpm<br/>10,000 Btu/lb VS<br/>89.5 kW<br/>-2.56 MMBtu/hr<br/>-2.56 MMBtu/hr<br/>0.00 MMBtu/hr<br/>0.00 MMBtu/hr<br/>18.86 MMBtu/hr<br/>18.86 MMBtu/hr<br/>0 lb/hr<br/>0 MW<br/>0.00 trucks/day<br/>0 gal/day<br/>571 scfm<br/>343 scfm<br/>0 scfm<br/>0 scfm<br/>0 lb/day</p> | <p>65,321 lb/hr<br/>1,770 lb/hr<br/>21.2 DTPD<br/>1,374 lb/hr<br/>63,551 lb/hr<br/>2.71%<br/>78%<br/>0 lb/hr<br/>130.5 gpm<br/>10,000 Btu/lb VS<br/>33.2 kW<br/>11.22 MMBtu/hr<br/>8.66 MMBtu/hr<br/>0.00 MMBtu/hr<br/>0.00 MMBtu/hr<br/>-13.20 MMBtu/hr<br/>5.66 MMBtu/hr<br/>0 lb/hr<br/>0 MW<br/>0.00 trucks/day<br/>0 gal/day<br/>0 scfm<br/>0 scfm<br/>-240 scfm<br/>0 scfm<br/>0 lb/day</p> | <p>65,321 lb/hr<br/>1,770 lb/hr<br/>21.2 DTPD<br/>1,374 lb/hr<br/>63,551 lb/hr<br/>2.71%<br/>78%<br/>0 lb/hr<br/>130.5 gpm<br/>10,000 Btu/lb VS<br/>0.0 kW<br/>0.00 MMBtu/hr<br/>8.66 MMBtu/hr<br/>0.00 MMBtu/hr<br/>0.00 MMBtu/hr<br/>-5.66 MMBtu/hr<br/>0.00 MMBtu/hr<br/>0 lb/hr<br/>0 MW<br/>0.00 trucks/day<br/>0 gal/day<br/>0 scfm<br/>0 scfm<br/>-103 scfm<br/>0 scfm<br/>0 lb/day</p> | <p>8,186 lb/hr<br/>1,637 lb/hr<br/>19.6 DTPD<br/>1,271 lb/hr<br/>6,549 lb/hr<br/>20.00%<br/>78%<br/>0 lb/hr<br/>16.4 gpm<br/>10,000 Btu/lb VS<br/>331.5 kW<br/>0.00 MMBtu/hr<br/>8.66 MMBtu/hr<br/>0.00 MMBtu/hr<br/>0.00 MMBtu/hr<br/>0.00 MMBtu/hr<br/>0.00 MMBtu/hr<br/>0 lb/hr<br/>0 MW<br/>0.00 trucks/day<br/>0 gal/day<br/>0 scfm<br/>0 scfm<br/>0 scfm<br/>0 scfm<br/>743 lb/day</p> | <p>8,186 lb/hr<br/>1,637 lb/hr<br/>19.6 DTPD<br/>1,271 lb/hr<br/>6,549 lb/hr<br/>20.00%<br/>78%<br/>0 lb/hr<br/>16.4 gpm<br/>10,000 Btu/lb VS<br/>0.0 kW<br/>0.00 MMBtu/hr<br/>8.66 MMBtu/hr<br/>0.00 MMBtu/hr<br/>0.00 MMBtu/hr<br/>0.00 MMBtu/hr<br/>0.00 MMBtu/hr<br/>0 lb/hr<br/>0 MW<br/>4.00 trucks/day<br/>0 gal/day<br/>0 scfm<br/>0 scfm<br/>0 scfm<br/>0 scfm<br/>0 lb/day</p> |

**Off-site Pyrolysis**

| Feedstock   | Drying and Pyrolysis  | Gas Utilization  | End Use   |  |
|---|---|--|---|--|
| <p>260925 PPD<br/>24.6%<br/>67.9%<br/>2%<br/>10,000 Bt/1b VS</p> <p>Feedstock Type<br/>PS + WAS</p> <p>Energy Consumption<br/>0 hpl/unit<br/>90% Efficiency</p>    | <p>Thermal Dryer 909<br/>NG LHV</p> <p>90.0% TS</p> <p>Nat gas usage, cth<br/>0<br/>0%</p> <p>Inlet / Out Temp.<br/>60 F<br/>300 F<br/>1,400 Bt/1b<br/>45.15 MMBt/1b</p> <p>Energy Consumption<br/>339 hpl/unit<br/>90% Efficiency<br/>Heat Loss 5%</p> <p>Duty No. 12</p>   | <p>Pyrolysis</p> <p>Therm Eff. 50%</p> <p>Heat Recovery<br/>21.29 MMBt/1b<br/>Enthalpy<br/>5.84 MMBt/1b</p> <p>Energy Consumption<br/>94 hpl/unit<br/>90% Efficiency</p> <p>Duty No. 24</p> <p>Temp (°C) 550</p>    | <p>Boiler 909<br/>NG LHV</p> <p>Therm Eff. 85%</p> <p>Nat gas usage, cth<br/>33,799<br/>Biogas Fuel use 0%</p> <p>Heat Recovery<br/>26.12 MMBt/1b</p> <p>Energy Consumption<br/>40 hpl/unit<br/>90% Efficiency</p> <p>Duty No. 2</p>    | <p>125590 PPD<br/>100.0%<br/>0%</p> <p>100% Contracted P3</p> <p>End Use<br/>Contracted P3</p> <p>Energy Consumption<br/>0 hpl/unit<br/>90% Efficiency</p>  |
| <p>44,166 lb/hr<br/>10,872 lb/hr<br/>130.5 DTPD<br/>7,382 lb/hr<br/>33,294 lb/hr<br/>24.62%<br/>68%<br/>148 lb/hr<br/>88.3 gpm<br/>10,000 Bt/1b VS<br/>0 kW<br/>0 MMBt/1b<br/>0 MMBt/1b<br/>0 MMBt/1b<br/>0 MMBt/1b<br/>0 MMBt/1b<br/>0 MMBt/1b<br/>0 MMBt/1b<br/>0 MW<br/>0.00 trucks/day<br/>0 gal/day<br/>0 scfm<br/>0 scfm<br/>0 scfm<br/>0 scfm<br/>0 lb/day</p> | <p>11,916 lb/hr<br/>10,724 lb/hr<br/>128.7 DTPD<br/>7,234 lb/hr<br/>1,192 lb/hr<br/>90.00%<br/>67%<br/>0 lb/hr<br/>23.8 gpm<br/>10,000 Bt/1b VS<br/>3366.9 kW<br/>-47.41 MMBt/1b<br/>-47.41 MMBt/1b<br/>0.00 MMBt/1b<br/>0.00 MMBt/1b<br/>0.00 MMBt/1b<br/>0.00 MMBt/1b<br/>0.00 MMBt/1b<br/>0 lb/hr<br/>0.00 MW<br/>0.00 trucks/day<br/>0 gal/day<br/>0 scfm<br/>0 scfm<br/>0 scfm<br/>0 scfm<br/>0 lb/day</p> | <p>5,233 lb/hr<br/>5,233 lb/hr<br/>62.8 DTPD<br/>1,743 lb/hr<br/>0 lb/hr<br/>100.00%<br/>33.3%<br/>0 lb/hr<br/>10.5 gpm<br/>10,000 Bt/1b VS<br/>1870.0 kW<br/>21.29 MMBt/1b<br/>-26.12 MMBt/1b<br/>0.00 MMBt/1b<br/>0.00 MMBt/1b<br/>0.00 MMBt/1b<br/>0.00 MMBt/1b<br/>0.00 MMBt/1b<br/>0 lb/hr<br/>0.00 MW<br/>0.00 trucks/day<br/>0 gal/day<br/>0 scfm<br/>0 scfm<br/>0 scfm<br/>0 scfm<br/>0 lb/day</p> | <p>5,233 lb/hr<br/>5,233 lb/hr<br/>62.8 DTPD<br/>1,743 lb/hr<br/>0 lb/hr<br/>100.00%<br/>0%<br/>0 lb/hr<br/>10.5 gpm<br/>10,000 Bt/1b VS<br/>66.3 kW<br/>26.12 MMBt/1b<br/>0.00 MMBt/1b<br/>0.00 MMBt/1b<br/>0.00 MMBt/1b<br/>0.00 MMBt/1b<br/>0.00 MMBt/1b<br/>0.00 MMBt/1b<br/>0 lb/hr<br/>0.00 MW<br/>3.00 trucks/day<br/>0 gal/day<br/>0 scfm<br/>0 scfm<br/>0 scfm<br/>0 scfm<br/>0 lb/day</p> |  |

| S4 Output Summary                   |       |
|-------------------------------------|-------|
| Final TS, Wet (WT/D)                | 0     |
| NG Req. (cfh)                       | 12804 |
| NG LHV (MMBtu/h)                    | 1.1   |
| Net heat (MMBtu/h)                  | 9     |
| Electricity Req. (kWh)              | 3868  |
| Power Generation (kWh)              | 1896  |
| Net Power (kWh)                     | -1762 |
| No. of Trucks Required (trucks/day) | 38    |
| Digester Gas Produced (scfm)**      | 3502  |
| Methane Produced (scfm)**           | 2101  |
| Scrubbed Gas (scfm)**               | 746   |
| Polymer Use (lb/day)                | 4344  |

Scenario 4 - TAD-Batch at West Point to Soil Blending, TAD-Batch at South Plant to direct Land App. and Brightwater with MAD and Off-site Composting









West Point

Off-site Soil Blending

| Feedstock              |                  | Stabilization            | Energy Recovery           | Gas Utilization               |                              |                             | Dewatering                    | End Use                        | Feedstock                     | Feedstock                   | Feedstock                   | End Use                     |
|------------------------|------------------|--------------------------|---------------------------|-------------------------------|------------------------------|-----------------------------|-------------------------------|--------------------------------|-------------------------------|-----------------------------|-----------------------------|-----------------------------|
| Dry Mass Flow          | 22560 PPD        | Digester (Thermo)        | HEX                       | CHP Engine                    | Boiler                       | Flare                       | Centrifuge                    | 93568 PPD                      | 93568 PPD                     | 45963 PPD                   | 252634 PPD                  | 392165 PPD                  |
| TS                     | 6.1%             |                          |                           | 145 ng/LHV                    | 40 ng/LHV                    |                             | 225 ng/LHV                    | 28.5%                          | 28.5%                         | 60.0%                       | 95.0%                       | 95.0%                       |
| VSR                    | 81%              | VSR 68.0%                |                           | 900 NG LHV                    | 900 NG LHV                   |                             | 92% Capture                   | 58%                            | 57.66%                        | 0.00%                       | 0.00%                       | 25%                         |
| Calorific Value        | 10,000 Btu/lb VS |                          |                           |                               |                              |                             |                               |                                | 10,000 Btu/lb VS              | 10,000 Btu/lb VS            | 10,000 Btu/lb VS            | 10,000 Btu/lb VS            |
| Feedstock Type         | PS + WAS         |                          |                           |                               |                              |                             |                               | End Use Off-Site Soil Blending | Feedstock Type Dewatered Cake | Feedstock Type Sandout      | Feedstock Type Fine Sand    | End Use Local Retail        |
| Energy Consumption     | 49 hp            | Energy Consumption 49 hp | Energy Consumption 100 hp | Energy Consumption 145 ng/LHV | Energy Consumption 40 ng/LHV | Energy Consumption 0 ng/LHV | Energy Consumption 225 ng/LHV | Energy Consumption 0 ng/LHV    | Energy Consumption 0 ng/LHV   | Energy Consumption 0 ng/LHV | Energy Consumption 0 ng/LHV | Energy Consumption 0 ng/LHV |
| Efficiency             | 90%              | 90%                      | 90%                       | 90%                           | 90%                          | 90%                         | 90%                           | 90%                            | 90%                           | 90%                         | 90%                         | 90%                         |
| Duty No.               | 5                | Duty No. 5               | Duty No. 1                | Duty No. 2                    | Duty No. 2                   | Duty No. 2                  | Duty No. 4                    |                                |                               |                             |                             |                             |
| Wet Mass Flow          | 154276 lb/hr     | 149,094 lb/hr            | 149,094 lb/hr             | 149,094 lb/hr                 | 149,094 lb/hr                | 149,094 lb/hr               | 13,680 lb/hr                  | 13,680 lb/hr                   | 13,680 lb/hr                  | 16,871 lb/hr                | 27,952 lb/hr                | 27,952 lb/hr                |
| Dry Mass Flow          | 9,411 lb/hr      | 4,229 lb/hr              | 4,229 lb/hr               | 4,229 lb/hr                   | 4,229 lb/hr                  | 4,229 lb/hr                 | 3,899 lb/hr                   | 3,899 lb/hr                    | 3,899 lb/hr                   | 5,814 lb/hr                 | 16,340 lb/hr                | 16,340 lb/hr                |
| VS                     | 112.9 DTPD       | 50.7 DTPD                | 50.7 DTPD                 | 50.7 DTPD                     | 50.7 DTPD                    | 50.7 DTPD                   | 46.8 DTPD                     | 46.8 DTPD                      | 46.8 DTPD                     | 69.8 DTPD                   | 196.1 DTPD                  | 196.1 DTPD                  |
| Water                  | 7,620 lb/hr      | 2,439 lb/hr              | 2,439 lb/hr               | 2,439 lb/hr                   | 2,439 lb/hr                  | 2,439 lb/hr                 | 2,248 lb/hr                   | 2,248 lb/hr                    | 2,248 lb/hr                   | 4,067 lb/hr                 | 4,067 lb/hr                 | 4,067 lb/hr                 |
| TS                     | 144,865 lb/hr    | 144,865 lb/hr            | 144,865 lb/hr             | 144,865 lb/hr                 | 144,865 lb/hr                | 144,865 lb/hr               | 9,781 lb/hr                   | 9,781 lb/hr                    | 9,781 lb/hr                   | 11,058 lb/hr                | 11,612 lb/hr                | 11,612 lb/hr                |
| VSR                    | 6.10%            | 2.84%                    | 2.84%                     | 2.84%                         | 2.84%                        | 2.84%                       | 28.50%                        | 28.50%                         | 28.50%                        | 34.46%                      | 58.46%                      | 58.46%                      |
| VS                     | 81%              | 58%                      | 58%                       | 58%                           | 58%                          | 58%                         | 58%                           | 58%                            | 58%                           | 70%                         | 29%                         | 29%                         |
| Wet flow               | 5,182 gpm        | 0 lb/hr                  | 0 lb/hr                   | 0 lb/hr                       | 0 lb/hr                      | 0 lb/hr                     | 0 lb/hr                       | 0 lb/hr                        | 0 lb/hr                       | 0 lb/hr                     | 0 lb/hr                     | 0 lb/hr                     |
| Calorific Value        | 306.3 gpm        | 297.9 gpm                | 297.9 gpm                 | 297.9 gpm                     | 297.9 gpm                    | 297.9 gpm                   | 27.3 gpm                      | 27.3 gpm                       | 27.3 gpm                      | 33.7 gpm                    | 55.9 gpm                    | 55.9 gpm                    |
| Electrical Demand      | 10,000 Btu/lb VS | 10,000 Btu/lb VS         | 10,000 Btu/lb VS          | 10,000 Btu/lb VS              | 10,000 Btu/lb VS             | 10,000 Btu/lb VS            | 10,000 Btu/lb VS              | 10,000 Btu/lb VS               | 10,000 Btu/lb VS              | 10,000 Btu/lb VS            | 10,000 Btu/lb VS            | 10,000 Btu/lb VS            |
| Total Heat Bal.        | 0.0 kW           | 165.8 kW                 | 124.3 kW                  | 239.7 kW                      | 66.3 kW                      | 0.0 kW                      | 746.0 kW                      | 0.0 kW                         | 0.0 kW                        | 0.0 kW                      | 0.0 kW                      | 0.0 kW                      |
| Cum. Aux. Fuel Bal.    | 0 MMBtu/hr       | -11.71 MMBtu/hr          | -1.66 MMBtu/hr            | -1.66 MMBtu/hr                | 0.51 MMBtu/hr                | 0.00 MMBtu/hr               | 0.00 MMBtu/hr                 | 0.00 MMBtu/hr                  | 0.00 MMBtu/hr                 | 0.00 MMBtu/hr               | 0.00 MMBtu/hr               | 0.00 MMBtu/hr               |
| Unit Process Fuel Bal. | 0 MMBtu/hr       | 0.00 MMBtu/hr            | 0.00 MMBtu/hr             | 0.00 MMBtu/hr                 | 0.00 MMBtu/hr                | 0.00 MMBtu/hr               | 0.00 MMBtu/hr                 | 0.00 MMBtu/hr                  | 0.00 MMBtu/hr                 | 0.00 MMBtu/hr               | 0.00 MMBtu/hr               | 0.00 MMBtu/hr               |
| Generated Steam        | 0 lb/hr          | 0 lb/hr                  | 0 lb/hr                   | 0 lb/hr                       | 0 lb/hr                      | 0 lb/hr                     | 0 lb/hr                       | 0 lb/hr                        | 0 lb/hr                       | 0 lb/hr                     | 0 lb/hr                     | 0 lb/hr                     |
| No. of Trucks Required | 0.00 trucks/day  | 0.00 trucks/day          | 0.00 trucks/day           | 0.00 trucks/day               | 0.00 trucks/day              | 0.00 trucks/day             | 0.00 trucks/day               | 0.00 trucks/day                | 0.00 trucks/day               | 0.00 trucks/day             | 0.00 trucks/day             | 0.00 trucks/day             |
| Digester Gas Produced  | 0 scfm           | 1295 scfm                | 0 scfm                    | 0 scfm                        | 0 scfm                       | 0 scfm                      | 0 scfm                        | 0 scfm                         | 0 scfm                        | 0 scfm                      | 0 scfm                      | 0 scfm                      |
| Methane Production     | 0 scfm           | 777 scfm                 | 0 scfm                    | 0 scfm                        | 0 scfm                       | 0 scfm                      | 0 scfm                        | 0 scfm                         | 0 scfm                        | 0 scfm                      | 0 scfm                      | 0 scfm                      |
| Methane Utilized       | 0 scfm           | 0 scfm                   | 0 scfm                    | -338 scfm                     | -45 scfm                     | -394 scfm                   | 0 scfm                        | 0 scfm                         | 0 scfm                        | 0 scfm                      | 0 scfm                      | 0 scfm                      |
| Scrubbed Gas           | 0 scfm           | 0 scfm                   | 0 scfm                    | 0 scfm                        | 0 scfm                       | 0 scfm                      | 0 scfm                        | 0 scfm                         | 0 scfm                        | 0 scfm                      | 0 scfm                      | 0 scfm                      |
| Unit Polymer Use       | 0 lb/day         | 0 lb/day                 | 0 lb/day                  | 0 lb/day                      | 0 lb/day                     | 0 lb/day                    | 1522 lb/day                   | 0 lb/day                       | 0 lb/day                      | 0 lb/day                    | 0 lb/day                    | 0 lb/day                    |













**South Plant**

| Feedstock  | Stabilization   | Energy Recovery   | Gas Utilization   |   |   |   | Dewatering   | End Use   |
|--|---|---|---|---|---|---|--|---|
| <p>263760 PPD<br/>6.2%<br/>85.88%<br/>64.0%<br/>10,000 Btu/lb VS</p> <p>Feedstock Type<br/>PS + WAS</p> <p>Energy Consumption<br/>0 hp/amt<br/>90% Efficiency</p>   | <p>Digester (Thermo)</p> <p>VSR 64.0%</p> <p>Sludge Inlet Temp F<br/>65<br/>Operation Temp F<br/>131<br/>160<br/>16.24 cflb VS<br/>11.70 MMBtu/hr</p> <p>Energy Consumption<br/>40 hp<br/>90% Efficiency<br/>Shell Heat Loss<br/>15%</p> <p>Duty No. 4</p>                           | <p>HEX</p> <p>Inlet Temperature F<br/>131<br/>Outlet Temperature F<br/>100</p> <p>HEX Efficiency %<br/>70<br/>3.72 MMBtu/hr</p> <p>Energy Consumption<br/>155 hp<br/>90% Efficiency</p> <p>Duty No. 1</p>    | <p>CHP Engine 909<br/>145 NG LHV</p> <p>Therm Eff. 38%</p> <p>Nat gas usage, cflb<br/>0<br/>Biogas Fuel use 0%</p> <p>Engine Electrical Eff. 30%</p> <p>Heat Recovery 0.00 MMBtu/hr</p> <p>Energy Consumption<br/>145 hp/amt<br/>90% Efficiency</p> <p>Duty No. 0</p>                          | <p>Boiler 909<br/>40 NG LHV</p> <p>Therm Eff. 85%</p> <p>Nat gas usage, cflb<br/>12,604<br/>Biogas Fuel use 0%</p> <p>Heat Recovery 9.74 MMBtu/hr</p> <p>Energy Consumption<br/>155 hp/amt<br/>90% Efficiency</p> <p>Duty No. 2</p>   | <p>Biogas Upgrading</p> <p>Nat gas usage, cflb<br/>0<br/>Biogas Fuel use 85%</p> <p>Energy Consumption<br/>727 hp/amt<br/>100% Efficiency</p> <p>Duty No. 1</p>    | <p>Flare</p> <p>Nat gas usage, cflb<br/>0<br/>Biogas Fuel use 85%</p> <p>Energy Consumption<br/>0 hp/amt<br/>90% Efficiency</p> <p>Duty No. 2</p>    | <p>Centrifuge</p> <p>95% Capture<br/>23% TS</p> <p>Energy Consumption<br/>225 hp/amt<br/>90% Efficiency</p> <p>Duty No. 4<br/>Polymer Use 35 lbs/DT</p>   | <p>112794 PPD<br/>22.3%<br/>69%</p> <p>End Use<br/>Land Application</p> <p>Energy Consumption<br/>0 hp/amt<br/>90% Efficiency</p>  |
| <p>177,258 lb/hr<br/>10,990 lb/hr<br/>131.9 DTPD<br/>9,439 lb/hr<br/>166,268 lb/hr<br/>8%<br/>5,041 lb/hr<br/>354.2 gpm<br/>10,000 Btu/lb VS<br/>0.0 kW<br/>0 MMBtu/hr<br/>0 MMBtu/hr<br/>0 MMBtu/hr<br/>0 MMBtu/hr<br/>0 lb/hr<br/>0 MW<br/>0.00 trucks/day<br/>0 gal/day<br/>0 scfm<br/>0 scfm<br/>0 scfm<br/>0 lb/day</p> | <p>171,217 lb/hr<br/>4,949 lb/hr<br/>59.4 DTPD<br/>3,398 lb/hr<br/>166,268 lb/hr<br/>2.89%<br/>69%<br/>0 lb/hr<br/>342.2 gpm<br/>10,000 Btu/lb VS<br/>122.3 kW<br/>-13.45 MMBtu/hr<br/>0.00 MMBtu/hr<br/>0.00 MMBtu/hr<br/>54.94 MMBtu/hr<br/>0 lb/hr<br/>0.00 MW<br/>0.00 trucks/day<br/>0 gal/day<br/>1635 scfm<br/>901 scfm<br/>0 scfm<br/>0 scfm<br/>0 lb/day</p> | <p>171,217 lb/hr<br/>4,949 lb/hr<br/>59.4 DTPD<br/>3,398 lb/hr<br/>166,268 lb/hr<br/>2.89%<br/>69%<br/>0 lb/hr<br/>342.2 gpm<br/>10,000 Btu/lb VS<br/>124.3 kW<br/>3.72 MMBtu/hr<br/>-9.74 MMBtu/hr<br/>0.00 MMBtu/hr<br/>0.00 MMBtu/hr<br/>54.94 MMBtu/hr<br/>0 lb/hr<br/>0.00 MW<br/>0.00 trucks/day<br/>0 gal/day<br/>0 scfm<br/>0 scfm<br/>0 scfm<br/>0 scfm<br/>0 lb/day</p> | <p>171,217 lb/hr<br/>4,949 lb/hr<br/>59.4 DTPD<br/>3,398 lb/hr<br/>166,268 lb/hr<br/>2.89%<br/>69%<br/>0 lb/hr<br/>342.2 gpm<br/>10,000 Btu/lb VS<br/>0.0 kW<br/>0.00 MMBtu/hr<br/>-9.74 MMBtu/hr<br/>0.00 MMBtu/hr<br/>0.00 MMBtu/hr<br/>54.94 MMBtu/hr<br/>0 lb/hr<br/>0.00 MW<br/>0.00 trucks/day<br/>0 gal/day<br/>0 scfm<br/>0 scfm<br/>0 scfm<br/>0 scfm<br/>0 lb/day</p> | <p>171,217 lb/hr<br/>4,949 lb/hr<br/>59.4 DTPD<br/>3,398 lb/hr<br/>166,268 lb/hr<br/>6.9%<br/>69%<br/>0 lb/hr<br/>342.2 gpm<br/>10,000 Btu/lb VS<br/>66.3 kW<br/>11.46 MMBtu/hr<br/>11.46 MMBtu/hr<br/>0.00 MMBtu/hr<br/>54.94 MMBtu/hr<br/>0 lb/hr<br/>0.00 MW<br/>0.00 trucks/day<br/>0 gal/day<br/>0 scfm<br/>0 scfm<br/>-329 scfm<br/>746 scfm<br/>0 lb/day</p> | <p>171,217 lb/hr<br/>4,949 lb/hr<br/>59.4 DTPD<br/>3,398 lb/hr<br/>166,268 lb/hr<br/>2.89%<br/>69%<br/>0 lb/hr<br/>342.2 gpm<br/>10,000 Btu/lb VS<br/>0.0 kW<br/>0.00 MMBtu/hr<br/>0.00 MMBtu/hr<br/>11.46 MMBtu/hr<br/>-46.42 MMBtu/hr<br/>8.52 MMBtu/hr<br/>0 lb/hr<br/>0.00 MW<br/>0.00 trucks/day<br/>0 gal/day<br/>0 scfm<br/>0 scfm<br/>-152 scfm<br/>0 scfm<br/>0 lb/day</p> | <p>20,523 lb/hr<br/>4,700 lb/hr<br/>56.4 DTPD<br/>3,227 lb/hr<br/>15,823 lb/hr<br/>69%<br/>41.0 gpm<br/>10,000 Btu/lb VS<br/>746.0 kW<br/>0.00 MMBtu/hr<br/>0.00 MMBtu/hr<br/>0.00 MMBtu/hr<br/>11.46 MMBtu/hr<br/>0.00 MMBtu/hr<br/>0.00 MMBtu/hr<br/>0.00 MMBtu/hr<br/>0 lb/hr<br/>0.00 MW<br/>0.00 trucks/day<br/>0 gal/day<br/>0 scfm<br/>0 scfm<br/>0 scfm<br/>0 scfm<br/>0 lb/day</p> | <p>20,523 lb/hr<br/>4,700 lb/hr<br/>56.4 DTPD<br/>3,227 lb/hr<br/>15,823 lb/hr<br/>22.90%<br/>69%<br/>0 lb/hr<br/>41.0 gpm<br/>10,000 Btu/lb VS<br/>0.0 kW<br/>0.00 MMBtu/hr<br/>0.00 MMBtu/hr<br/>11.46 MMBtu/hr<br/>0.00 MMBtu/hr<br/>0.00 MMBtu/hr<br/>0.00 MMBtu/hr<br/>0 lb/hr<br/>0.00 MW<br/>8.00 trucks/day<br/>0 gal/day<br/>0 scfm<br/>0 scfm<br/>0 scfm<br/>0 scfm<br/>0 lb/day</p> |   |

**Brightwater**

**Off-site Composting**

| Feedstock   |  | Stabilization   | Gas Utilization  |   | Dewatering  | End Use   | Feedstock   | Feedstock  | Feedstock  | Stabilization   | End Use |
|---|--|---|--|---|---|---|---|--|--|---|---------|
| <p>93810 PPD<br/>5.8%<br/>90%<br/>61%<br/>10,000</p> <p>Butlb VS</p> <p>Feedstock Type<br/>PS + WAS</p> <p>Energy Consumption<br/>0 hp/amt<br/>90% Efficiency</p>    | <p>Digester (Meso)</p> <p>VSR 60.8%</p> <p>Sludge Inlet Temp<br/>65 F<br/>Operation Temp<br/>98 F<br/>550 Butlb VS<br/>16 cfb VS<br/>2.23 MMBtu/hr</p> <p>Energy Consumption<br/>40 hp/amt<br/>100% Efficiency<br/>Shell Heat Loss<br/>15%</p> <p>Duty No. 3</p>    | <p>Boiler 909<br/>NG LHV</p> <p>Therm Eff. 85%</p> <p>Nat gas usage, cfb<br/>0<br/>Biogas Fuel use 70%</p> <p>Heat Recovery<br/>11.22 MMBtu/hr</p> <p>Energy Consumption<br/>40 hp/amt<br/>90% Efficiency</p> <p>Duty No. 1</p>    | <p>Flare</p> <p>Energy Consumption<br/>0 hp/amt<br/>90% Efficiency</p> <p>Duty No. 1</p>    | <p>Centrifuge</p> <p>93% Capture<br/>20% TS</p> <p>Energy Consumption<br/>200 hp/amt<br/>90% Efficiency</p> <p>Duty No. 2<br/>Polymer Use<br/>35 lbs/DT</p>    | <p>39295 PPD<br/>20.0%<br/>78%</p> <p>End Use<br/>Land Application</p> <p>Energy Consumption<br/>0 hp/amt<br/>90% Efficiency</p>    | <p>39295 PPD<br/>20.0%<br/>77.61%<br/>15.0%<br/>10,000</p> <p>Butlb VS</p> <p>Feedstock Type<br/>Dewatered Cake</p> <p>Energy Consumption<br/>0 hp/amt<br/>90% Efficiency</p>    | <p>132465 PPD<br/>55.0%<br/>95.00%<br/>15.0%<br/>10,000</p> <p>Butlb VS</p> <p>Feedstock Type<br/>Virgin Woodchips</p> <p>Energy Consumption<br/>0 hp/amt<br/>90% Efficiency</p>   | <p>18611 PPD<br/>55.0%<br/>89.68%<br/>15.0%<br/>10,000</p> <p>Butlb VS</p> <p>Feedstock Type<br/>Screened Overs</p> <p>Energy Consumption<br/>0 hp/amt<br/>90% Efficiency</p>   | <p>Compost</p> <p>50% VSR<br/>15.0% TS</p> <p>Energy Consumption<br/>250 hp<br/>90% Efficiency</p> <p>Duty No. 1</p>  | <p>162885 PPD<br/>59.0%<br/>88%</p> <p>End Use<br/>Local Retail</p> <p>Energy Consumption<br/>0 hp/amt<br/>90% Efficiency</p>  |         |
| <p>67,464 lb/hr<br/>3,913 lb/hr<br/>47.0 DTPD<br/>3,517 lb/hr<br/>63,551 lb/hr<br/>5.80%<br/>90%<br/>2,143 lb/hr<br/>134.8 gpm<br/>10,000 Butlb VS<br/>0 kW<br/>0 MMBtu/hr<br/>-2.56 MMBtu/hr<br/>0 MMBtu/hr<br/>0 MMBtu/hr<br/>0 MMBtu/hr<br/>18.86 MMBtu/hr<br/>0 lb/hr<br/>0 MW<br/>0.00 trucks/day<br/>0 gal/day<br/>0 scfm<br/>343 scfm<br/>0 scfm<br/>0 scfm<br/>0 lb/day</p> | <p>65,321 lb/hr<br/>1,770 lb/hr<br/>21.2 DTPD<br/>1,374 lb/hr<br/>63,551 lb/hr<br/>2.71%<br/>78%<br/>0 lb/hr<br/>130.5 gpm<br/>10,000 Butlb VS<br/>89.5 kW<br/>11.22 MMBtu/hr<br/>8.66 MMBtu/hr<br/>0.00 MMBtu/hr<br/>0.00 MMBtu/hr<br/>0.00 MMBtu/hr<br/>-13.29 MMBtu/hr<br/>5.66 MMBtu/hr<br/>0 lb/hr<br/>0 MW<br/>0.00 trucks/day<br/>0 gal/day<br/>371 scfm<br/>0 scfm<br/>-240 scfm<br/>0 scfm<br/>0 lb/day</p> | <p>65,321 lb/hr<br/>1,770 lb/hr<br/>21.2 DTPD<br/>1,374 lb/hr<br/>63,551 lb/hr<br/>2.71%<br/>78%<br/>0 lb/hr<br/>130.5 gpm<br/>10,000 Butlb VS<br/>52.2 kW<br/>11.22 MMBtu/hr<br/>8.66 MMBtu/hr<br/>0.00 MMBtu/hr<br/>0.00 MMBtu/hr<br/>0.00 MMBtu/hr<br/>-5.66 MMBtu/hr<br/>5.66 MMBtu/hr<br/>0 lb/hr<br/>0 MW<br/>0.00 trucks/day<br/>0 gal/day<br/>0 scfm<br/>0 scfm<br/>-103 scfm<br/>0 scfm<br/>0 lb/day</p> | <p>65,321 lb/hr<br/>1,770 lb/hr<br/>21.2 DTPD<br/>1,374 lb/hr<br/>63,551 lb/hr<br/>2.71%<br/>78%<br/>0 lb/hr<br/>130.5 gpm<br/>10,000 Butlb VS<br/>0.0 kW<br/>0.00 MMBtu/hr<br/>8.66 MMBtu/hr<br/>0.00 MMBtu/hr<br/>0.00 MMBtu/hr<br/>0.00 MMBtu/hr<br/>0.00 MMBtu/hr<br/>0.00 MMBtu/hr<br/>0 lb/hr<br/>0 MW<br/>0.00 trucks/day<br/>0 gal/day<br/>0 scfm<br/>0 scfm<br/>-103 scfm<br/>0 scfm<br/>0 lb/day</p> | <p>8,186 lb/hr<br/>1,637 lb/hr<br/>19.6 DTPD<br/>1,271 lb/hr<br/>6,549 lb/hr<br/>20.00%<br/>78%<br/>0 lb/hr<br/>16.4 gpm<br/>10,000 Butlb VS<br/>331.8 kW<br/>0.00 MMBtu/hr<br/>8.66 MMBtu/hr<br/>0.00 MMBtu/hr<br/>0.00 MMBtu/hr<br/>0.00 MMBtu/hr<br/>0.00 MMBtu/hr<br/>0.00 MMBtu/hr<br/>0 lb/hr<br/>0 MW<br/>4.00 trucks/day<br/>0 gal/day<br/>0 scfm<br/>0 scfm<br/>0 scfm<br/>0 scfm<br/>0 lb/day</p> | <p>8,186 lb/hr<br/>1,637 lb/hr<br/>19.6 DTPD<br/>1,271 lb/hr<br/>6,549 lb/hr<br/>20.00%<br/>78%<br/>0 lb/hr<br/>16.4 gpm<br/>10,000 Butlb VS<br/>0.0 kW<br/>0.00 MMBtu/hr<br/>8.66 MMBtu/hr<br/>0.00 MMBtu/hr<br/>0.00 MMBtu/hr<br/>0.00 MMBtu/hr<br/>0.00 MMBtu/hr<br/>0.00 MMBtu/hr<br/>0 lb/hr<br/>0 MW<br/>0.00 trucks/day<br/>0 gal/day<br/>0 scfm<br/>0 scfm<br/>0 scfm<br/>0 scfm<br/>0 lb/day</p> | <p>18,222 lb/hr<br/>7,157 lb/hr<br/>85.9 DTPD<br/>6,514 lb/hr<br/>11,965 lb/hr<br/>39.28%<br/>91%<br/>977 lb/hr<br/>36.4 gpm<br/>10,000 Butlb VS<br/>0.0 kW<br/>0.00 MMBtu/hr<br/>0.00 MMBtu/hr<br/>0.00 MMBtu/hr<br/>0.00 MMBtu/hr<br/>0.00 MMBtu/hr<br/>0.00 MMBtu/hr<br/>0.00 MMBtu/hr<br/>0 lb/hr<br/>0 MW<br/>0.00 trucks/day<br/>0 gal/day<br/>0 scfm<br/>0 scfm<br/>0 scfm<br/>0 scfm<br/>0 lb/day</p> | <p>19,490 lb/hr<br/>7,849 lb/hr<br/>84.2 DTPD<br/>7,135 lb/hr<br/>11,631 lb/hr<br/>40.29%<br/>91%<br/>1,070 lb/hr<br/>38.9 gpm<br/>10,000 Butlb VS<br/>0.0 kW<br/>0.00 MMBtu/hr<br/>0.00 MMBtu/hr<br/>0.00 MMBtu/hr<br/>0.00 MMBtu/hr<br/>0.00 MMBtu/hr<br/>0.00 MMBtu/hr<br/>0.00 MMBtu/hr<br/>0 lb/hr<br/>0 MW<br/>0.00 trucks/day<br/>0 gal/day<br/>0 scfm<br/>0 scfm<br/>0 scfm<br/>0 scfm<br/>0 lb/day</p> | <p>13,557 lb/hr<br/>6,779 lb/hr<br/>81.3 DTPD<br/>6,065 lb/hr<br/>6,779 lb/hr<br/>50.00%<br/>89%<br/>0 lb/hr<br/>27.1 gpm<br/>10,000 Butlb VS<br/>215.5 kW<br/>0.00 MMBtu/hr<br/>0.00 MMBtu/hr<br/>0.00 MMBtu/hr<br/>0.00 MMBtu/hr<br/>0.00 MMBtu/hr<br/>0.00 MMBtu/hr<br/>0.00 MMBtu/hr<br/>0 lb/hr<br/>0 MW<br/>0.00 trucks/day<br/>0 gal/day<br/>0 scfm<br/>0 scfm<br/>0 scfm<br/>0 scfm<br/>0 lb/day</p> |  |   |         |

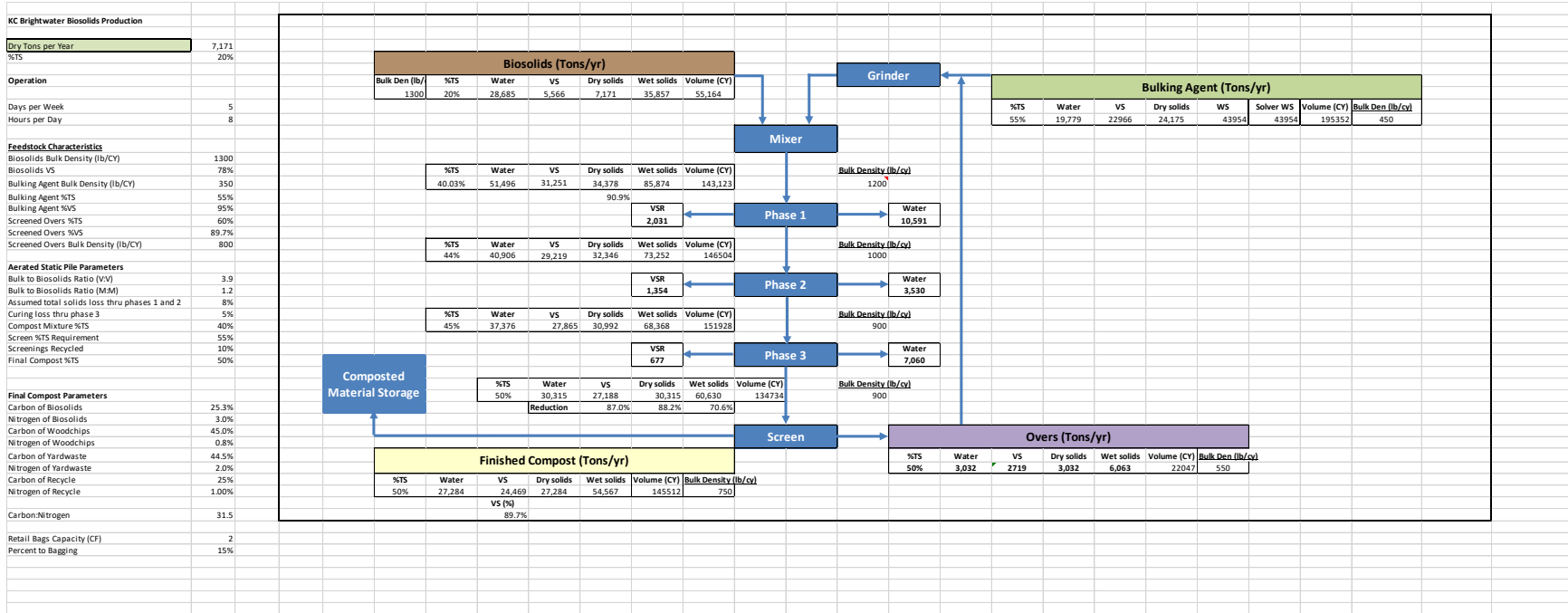

| Equipment Sizing  | Manufacturer              | Capacity (CF/batch) | Real Capacity (CY/batch) | Batches per Hour | Throughput (CY/Day)   | Required Volume Mixed (CY/Day) | Number of Equipment (N+1) |
|-------------------|---------------------------|---------------------|--------------------------|------------------|-----------------------|--------------------------------|---------------------------|
| Equipment         | ECS/Lucknow 2295          | 1100                | 28.5                     | 4                | 798.5                 | 550                            | 2                         |
| Equipment         | Manufacturer              | Capacity (CF/hr)    | Real Capacity (CY/hr)    | Batches per Hour | Throughput (CY/Day)   | Required Throughput (CY/Day)   | Number of Equipment       |
| Equipment         | MultiStar L3 Type         | 8825                | 261                      | N/A              | 1830                  | 518                            | 1                         |
| Equipment         | Manufacturer              | Capacity (CF/bag)   | Real Capacity (CF/bag)   | Bags per Hour    | Throughput (Bags/Day) | Required Throughput (Bags/Day) | Number of Equipment       |
| Bagging Equipment | RotoChopper Go-Bagger 250 | 2                   | 2                        | 250              | 1750                  | 1133                           | 1                         |

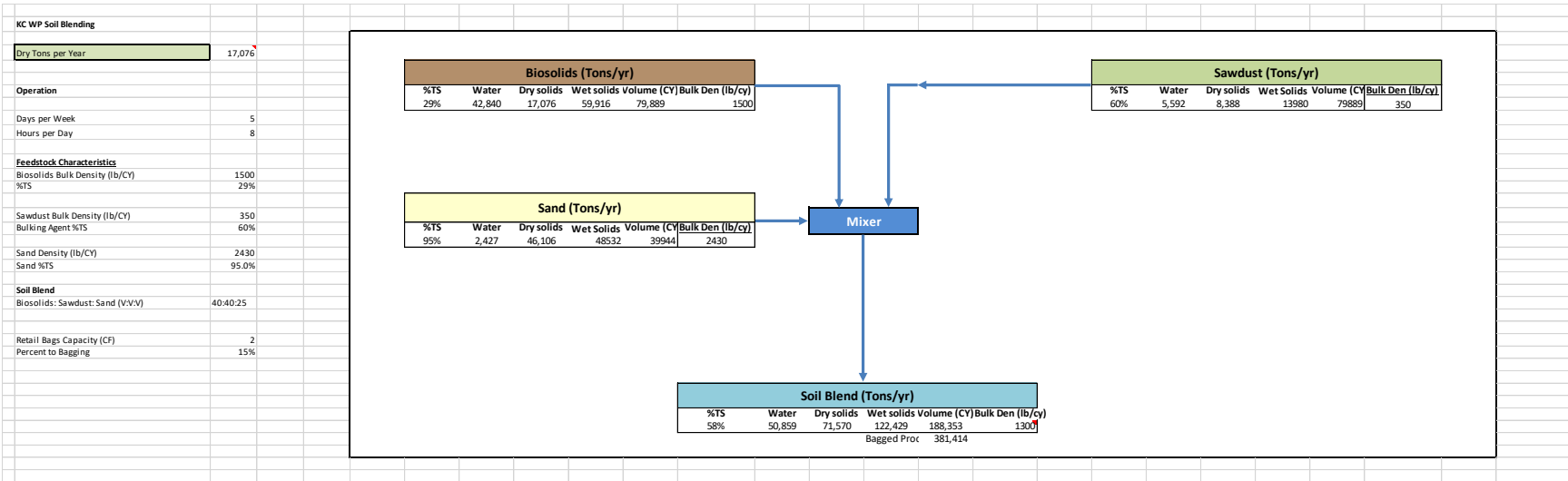

| Equipment Sizing                               |                           |                     |                          |                  |                       |                                |                           |
|--|---------------------------|---------------------|--------------------------|------------------|-----------------------|--------------------------------|---------------------------|
| Equipment                                      | Manufacturer              | Capacity (CF/batch) | Real Capacity (CY/batch) | Batches per Hour | Throughput (CY/Day)   | Required Volume Mixed (CY/Day) | Number of Equipment (N+1) |
| Horizontal Mixer                               | RotoMix 1220-20           | 1220                | 31.6                     | 4                | 885.6                 | 768                            | 2                         |
| Equipment                                      | Manufacturer              | Capacity (CF/hr)    | Real Capacity (CY/hr)    | Batches per Hour | Throughput (CY/Day)   | Required Throughput (CY/Day)   | Number of Equipment       |
| Screen   | MultiStar L3 Type         | 8825                | 261                      | N/A              | 1830                  | 724                            | 1                         |
| Compost Screener can be used as redundant unit |                           |                     |                          |                  |                       |                                |                           |
| Equipment                                      | Manufacturer              | Capacity (CF/bag)   | Real Capacity (CF/bag)   | Bags per Hour    | Throughput (Bags/Day) | Required Throughput (Bags/Day) | Number of Equipment       |
| Bagging Equipment                              | RotoChopper Go-Bagger 250 | 2                   | 2                        | 250              | 1750                  | 1467                           | 1                         |

Biochar Carbon Sequestration

$$22,920 \frac{DT}{yr} \text{ Biochar} \times 28.6\% \text{ Carbon} = 6,555 \frac{tons}{yr} \text{ carbon}$$

$$6,555 \frac{tons}{yr} \text{ carbon} \times 90\% \text{ Fixed} = 5,900 \frac{tons}{yr} \text{ fixed carbon}$$

$$5,900 \frac{tons}{yr} \text{ fixed carbon} \times 907 \frac{kg}{ton} = 5,352,006 \frac{kg}{yr} \text{ fixed carbon}$$

$$5,352,006 \frac{kg}{yr} \text{ fixed carbon} \times \frac{44 \text{ CO}_2}{12 \text{ C}} = 19,624,023 \frac{kg \text{ CO}_2e}{yr}$$

$$\frac{19,624,023 \frac{kg \text{ CO}_2e}{yr}}{21,017,640 \frac{kg \text{ biochar}}{yr}} = 0.9337 \frac{kg \text{ CO}_2e}{kg \text{ biochar}}$$

## Attachment B: Solids-Water-Energy Evaluation Tool Results

---





| Scenario   | Facility    | Stabilization | Dewatering | Post Dewatering | Biosolids Classification       | End-Use                          |
|------------|-------------|---------------|------------|-----------------|--------------------------------|----------------------------------|
| Scenario 1 | West Point  | MAD           | Centrifuge | -               | Class B                        | Land Application<br>West/East WA |
|            | South Plant | MAD           |            |                 |                                |                                  |
|            | Brightwater | MAD           |            |                 |                                |                                  |
| Scenario 2 | West Point  | TAD-Batch     | Centrifuge | Composting      | Class A                        | Local Retail                     |
|            | South Plant | THP-MAD       |            | -               |                                | Land Application West/East WA    |
|            | Brightwater | MAD           |            | Soil Blending   |                                | Local Retail                     |
| Scenario 3 | West Point  | MAD           | Centrifuge | Pyrolysis       | Unknown (Potential<br>Class A) | Regional Retail                  |
|            | South Plant | MAD           |            |                 |                                |                                  |
|            | Brightwater | MAD           |            |                 |                                |                                  |
| Scenario 4 | West Point  | TAD-Batch     | Centrifuge | Composting      | Class A                        | Local Retail                     |
|            | South Plant | TAD-Batch     |            | -               |                                | Land Application West/East WA    |
|            | Brightwater | MAD           |            | Soil Blending   |                                | Local Retail                     |

| Parameter                             | S1   | S2   | S3   | S4   |
|---------------------------------------|------|------|------|------|
| Final Product, Wet (WT/d)             | 539  | 689  | 63   | 744  |
| Trucks Required (Trucks/d)            | 19   | 67   | 22   | 68   |
| Vehicle Fuel Consumption (gal/day)    | 1952 | 1360 | 104  | 1445 |
| Electricity Demand (MWh/d)            | 75   | 101  | 203  | 85   |
| Electricity Generation (MWh/d)        | -42  | -45  | -42  | -45  |
| Net Power (MWh/d)*                    | 33   | 56   | 160  | 40   |
| Natural Gas Consumption (scfm)        | 145  | 260  | 708  | 210  |
| Digester Gas Produced (scfm)          | 3325 | 3419 | 3325 | 3502 |
| Methane Injected into Pipeline (scfm) | 778  | 787  | 778  | 829  |
| Polymer Use (lb/day)                  | 4611 | 6359 | 4611 | 4344 |

| <b>Fuel Consumption</b> | <b>S1</b>  | <b>S2</b>   | <b>S3</b>   | <b>S4</b>   |
|-------------------------|------------|-------------|-------------|-------------|
| Natural Gas (SCF/yr)    | 76,267,424 | 136,752,625 | 372,349,651 | 110,410,948 |
| Natural Gas (MMBtu/yr)  | 76,267     | 136,753     | 372,350     | 110,411     |
| Diesel (gal/yr)         | 712,453    | 496,321     | 77,773      | 527,438     |
| Diesel (MMBtu/yr)       | 97,877     | 68,185      | 10,685      | 72,460      |
| Total MMBtu/yr          | 174,145    | 204,938     | 383,034     | 182,871     |

| <b>Hauling and Trucking</b> | <b>S1</b> | <b>S2</b> | <b>S3</b> | <b>S4</b> |
|-----------------------------|-----------|-----------|-----------|-----------|
| Local Trucking              | 0         | 21,855    | 6,935     | 21,855    |
| Long Haul Trucking          | 6,935     | 2,555     | 1,095     | 2,920     |

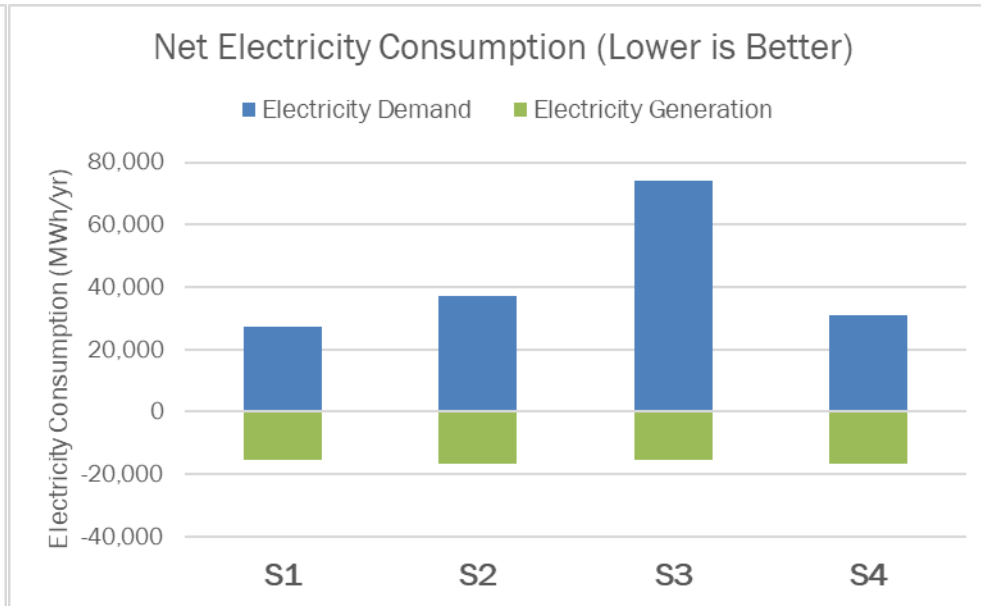
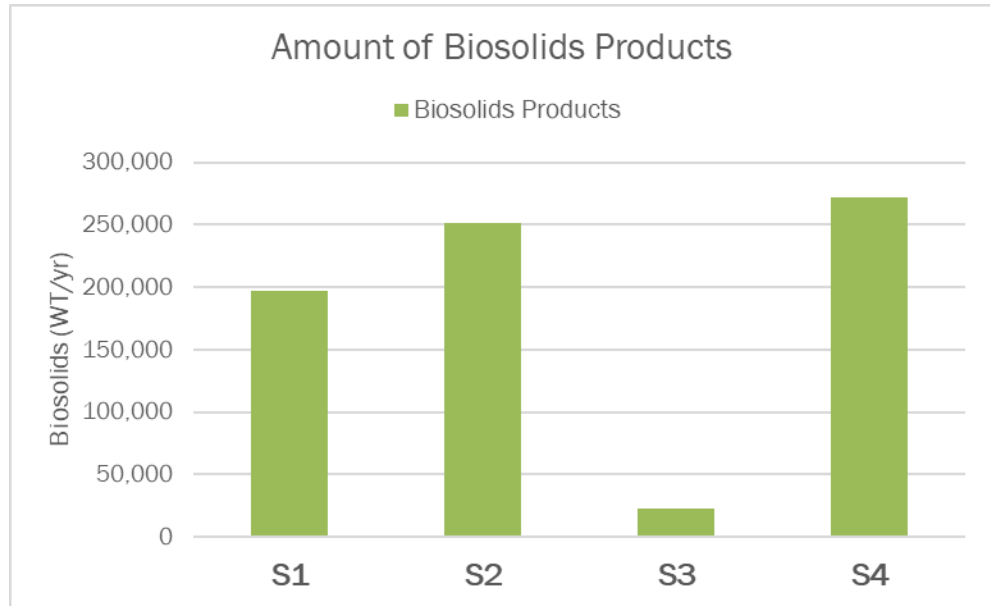
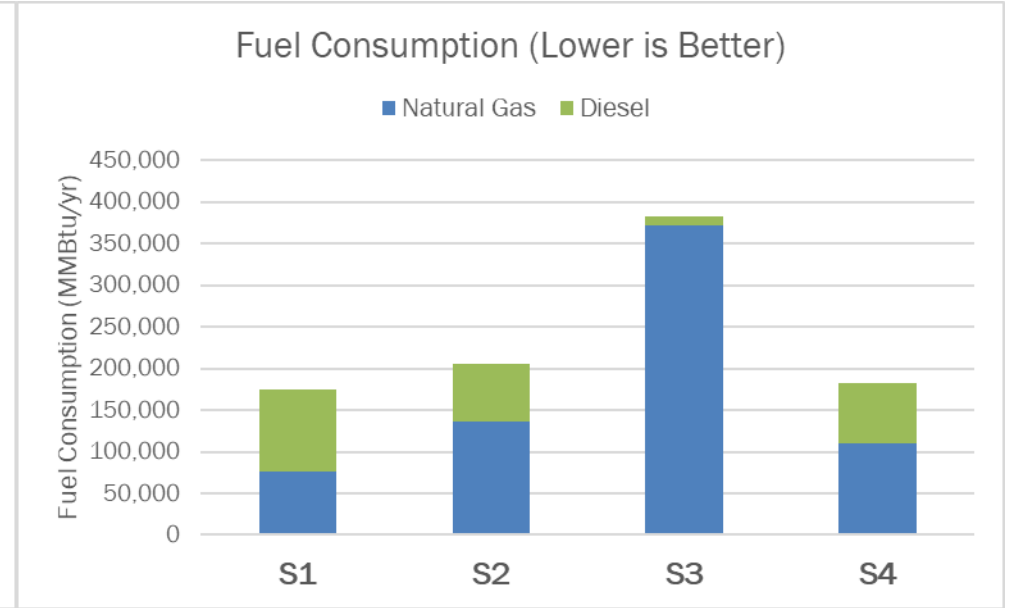
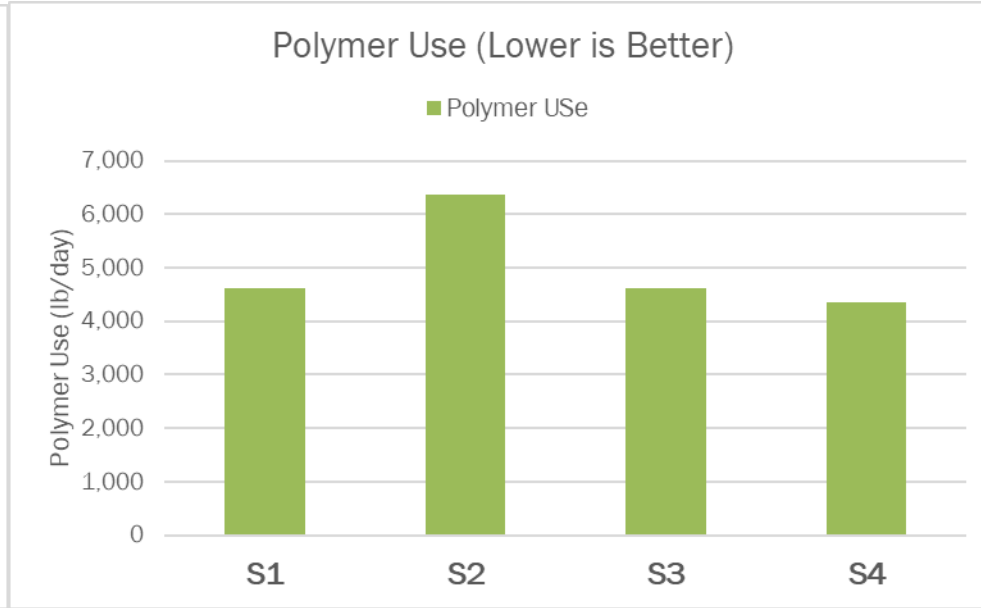
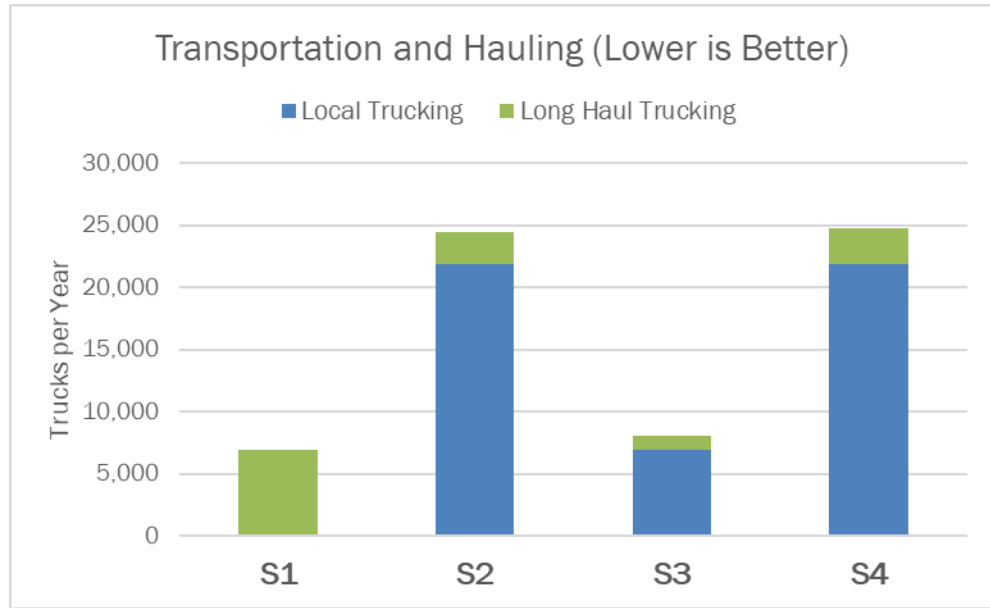

| Performance Summary               |                    |   | 1   | 2  | 3                  |  |
|-----------------------------------|--------------------|---|---|--|--------------------|--|
| Solids Flows and Loads            |                    |   | 100% Class B application with MAD at all three plants | TAD-Batch , Cambi, and Off-site Soilblending or Composting | Off-site Pyrolysis | TAD-Batch and Off-site Soil blending or Composting |
| Element                           | Notes              |   | S1  | S2   | S3                 | S4   |
| <b>West Point Treatment plant</b> |                    |   |   |  |                    |  |
| <b>Solids Loading and Flows</b>   |                    |   |   |  |                    |  |
|                                   | PS + WAS           | Average Digester Feed Load, dry lbs TS/hr | 9,410.8   | 9,410.8  | 9,410.8            | 9,410.8  |
|                                   | PS + WAS           | Average Digester Feed Load, %TS           | 6.1%  | 6.1%   | 6.1%               | 6%   |
|                                   | PS + WAS           | Average Digester Feed Load, %VS           | 81.0%   | 81.0%  | 81.0%              | 81%  |
| <b>Stabilization</b>              |                    |   |   |  |                    |  |
|                                   | Digester           | Type                                      | MAD   | TAD-BATCH  | MAD                | TAD-BATCH  |
|                                   | Digester           | Biogas Production, mmbtu/hr               | 40.6  | 43.5   | 40.6               | 44   |
|                                   | Digester           | Biogas Production, SCFM                   | 1,219.5   | 1,295.5  | 1,219.5            | 1295   |
|                                   | Digester           | Methane Production, SCFM                  | 731.7   | 777.3  | 731.7              | 777  |
| <b>Gas Utilization</b>            |                    |   |   |  |                    |  |
|                                   | Cogen              | Biogas Utilization, mmbtu/hr              | -17.7   | -18.9  | -17.7              | -18.9  |
|                                   | Cogen              | Methane Utilization, SCFM                 | -318.3  | -338.1   | -318.3             | -338.1   |
|                                   | Boiler             | Biogas Utilization, mmbtu/hr              | -2.4  | -2.5   | -2.4               | -2.5   |
|                                   | Boiler             | Methane Utilization, SCFM                 | -42.8   | -45.5  | -42.8              | -45.5  |
|                                   | Boiler             | NG Utilization, mmbtu/hr                  | 0.0   | 0.0  | 0.0                | 0.0  |
|                                   | Boiler             | NG Utilization, SCFM                      | 0.0   | 0.0  | 0.0                | 0.0  |
|                                   | Gas Upgrading      | Biogas Utilization, mmbtu/hr              | 0.0   | 0.0  | 0.0                | 0.0  |
|                                   | Gas Upgrading      | Methane Utilization, SCFM                 | 0.0   | 0.0  | 0.0                | 0.0  |
|                                   | Flare              | Biogas Utilization, mmbtu/hr              | -20.6   | -22.0  | -20.6              | -22.0  |
|                                   | Flare              | Methane Utilization, SCFM                 | -370.6  | -393.7   | -370.6             | -393.7   |
| <b>Thermal Supply</b>             |                    |   |   |  |                    |  |
|                                   | Heat Exchanger     | Thermal Energy Production, mmbtu/hr       | 0.0   | 3.2  | 0.0                | 3.2  |
|                                   | Cogen              | Thermal Energy Production, mmbtu/hr       | 6.4   | 6.8  | 6.4                | 6.8  |
|                                   | Boiler (biogas)    | Thermal Energy Production, mmbtu/hr       | 2.0   | 2.2  | 2.0                | 2.2  |
|                                   | Boiler (NG)        | Thermal Energy Production, mmbtu/hr       | 0.0   | 0.0  | 0.0                | 0.0  |
|                                   | Subtotal           | Thermal Energy Production, mmbtu/yr       | 73,395.0  | 107,014.1  | 73,395.0           | 107014.1   |
| <b>Thermal Demand</b>             |                    |   |   |  |                    |  |
|                                   | Digester           | Thermal Energy Demand, mmbtu/hr           | -5.9  | -11.7  | -5.9               | -11.7  |
|                                   | Thermal Hydrolysis | Thermal Energy Demand, mmbtu/hr           | 0.0   | 0.0  | 0.0                | 0.0  |
|                                   | Pyrolysis          | Thermal Energy Demand, mmbtu/hr           | 0.0   | 0.0  | 0.0                | 0.0  |
|                                   | Subtotal           | Thermal Energy Demand, mmbtu/yr           | -51,287.8   | -102,575.6   | -51,287.8          | -102575.6  |
| <b>Total Thermal Balance</b>      |                    |   |   |  |                    |  |
|                                   | Solids Treatment   | Thermal Energy Total, mmbtu/yr            | 22,107.2  | 4,438.5  | 22,107.2           | 4,438.5  |
| <b>Electricity Consumption</b>    |                    |   |   |  |                    |  |
|                                   | Digestion          | Electricity Load, kW                      | -149.2  | -165.8   | -149.2             | -165.8   |
|                                   | Heat Exchanger     | Electricity Load, kW                      | 0.0   | -124.3   | 0.0                | -124.3   |
|                                   | CHP                | Parasitic Loads, kW                       | -239.7  | -239.7   | -239.7             | -239.7   |
|                                   | Boiler             | Parasitic loads, kW                       | -66.3   | -66.3  | -66.3              | -66.3  |
|                                   | Gas Upgrading      | Parasitic loads, kW                       | 0.0   | 1.0  | 0.0                | 1.0  |
|                                   | Flare              | Parasitic loads, kW                       | 0.0   | 0.0  | 0.0                | 0.0  |

|                                  |                  |   |           |           |           |           |
|----------------------------------|------------------|---|-----------|-----------|-----------|-----------|
|                                  | Dewatering       | Electricity Load, kW                      | -746.0    | -746.0    | -746.0    | -746.0    |
|                                  | Subtotal         | Electricity Load, MWh/yr                  | -10,522.8 | -11,748.5 | -10,522.8 | -11,748.5 |
| <b>Electricity Production</b>    |                  |   |           |           |           |           |
|                                  | CHP              | Electricity Production, kW                | 1,759.7   | 1,886.3   | 1,759.7   | 1,886.3   |
|                                  | CHP              | Electricity Production, MWh/yr            | 15,415.3  | 16,523.7  | 15,415.3  | 16,523.7  |
| <b>Total Electricity Balance</b> |                  |   |           |           |           |           |
|                                  | Solids Treatment | Electricity Total, MWh/yr                 | -10,522.8 | -11,748.5 | -10,522.8 | -11,748.5 |
|                                  | Solids Treatment | Electricity Export, kWh/yr                | 15,415.3  | 16,523.7  | 15,415.3  | 16,523.7  |
|                                  | Solids Treatment | Electricity Import, kWh/yr                | 10,522.8  | 11,748.5  | 10,522.8  | 11,748.5  |
| <b>Chemical Usage</b>            |                  |   |           |           |           |           |
|                                  | Dewatering       | Polymer Use, lb per year                  | 595,636.8 | 555,684.0 | 595,636.8 | 555,684.0 |
| <b>Hauled Solids</b>             |                  |   |           |           |           |           |
|                                  | Hauling          | Average Hauled, wet tons/yr               | 64,224.3  | 59,916.4  | 64,224.3  | 59,916.4  |
|                                  | Hauling          | Dry Solids, %                             | 28.5%     | 28.5%     | 28.5%     | 28.5%     |
|                                  | Hauling          | Trucks per Day                            | 6.0       | 6.0       | 6.0       | 6.0       |
|                                  | Hauling          | Trucks per Year                           | 2,190.0   | 2,190.0   | 2,190.0   | 2,190.0   |
| <b>South Treatment Plant</b>     |                  |   |           |           |           |           |
| <b>Solids Loading and Flows</b>  |                  |   |           |           |           |           |
|                                  | PS + WAS         | Average Digester Feed Load, dry lbs TS/hr | 10,990.0  | 10,990.0  | 10,990.0  | 10,990.0  |
|                                  | PS + WAS         | Average Digester Feed Load, %TS           | 6.2%      | 6.2%      | 6.2%      | 6.2%      |
|                                  | PS + WAS         | Average Digester Feed Load, %VS           | 85.9%     | 85.9%     | 85.9%     | 85.9%     |
| <b>Stabilization</b>             |                  |   |           |           |           |           |
|                                  | Digester         | Type                                      | MAD       | THP-MAD   | MAD       | TAD-Batch |
|                                  | Digester         | Biogas Production, mmbtu/hr               | 50.6      | 51.2      | 50.6      | 54.94     |
|                                  | Digester         | Biogas Production, SCFM                   | 1,533.6   | 1,552.3   | 1,533.6   | 1,635.04  |
|                                  | Digester         | Methane Production, SCFM                  | 920.2     | 931.4     | 920.2     | 981.03    |
| <b>Gas Utilization</b>           |                  |   |           |           |           |           |
|                                  | Cogen            | Biogas Utilization, mmbtu/hr              | 0.0       | 0.0       | 0.0       | 0.0       |
|                                  | Cogen            | Methane Utilization, SCFM                 | 0.0       | 0.0       | 0.0       | 0.0       |
|                                  | Boiler           | Biogas Utilization, mmbtu/hr              | 0.0       | 0.0       | 0.0       | 0.0       |
|                                  | Boiler           | Methane Utilization, SCFM                 | 0.0       | 0.0       | 0.0       | 0.0       |
|                                  | Boiler           | NG Utilization, mmbtu/hr                  | -7.9      | -14.2     | -7.9      | -11.5     |
|                                  | Boiler           | NG Utilization, SCFM                      | -145.1    | -260.2    | -145.1    | -210.1    |
|                                  | Gas Upgrading    | Biogas Utilization, mmbtu/hr              | -42.8     | -43.3     | -42.8     | -46.4     |
|                                  | Gas Upgrading    | Methane Utilization, SCFM                 | -777.5    | -787.0    | -777.5    | -829.0    |
|                                  | Flare            | Biogas Utilization, mmbtu/hr              | -7.8      | -7.9      | -7.8      | -8.5      |
|                                  | Flare            | Methane Utilization, SCFM                 | -142.6    | -144.4    | -142.6    | -152.1    |
| <b>Thermal Supply</b>            |                  |   |           |           |           |           |
|                                  | Cogen            | Thermal Energy Production, mmbtu/hr       | 0.0       | 0.0       | 0.0       | 0         |
|                                  | Boiler (Biogas)  | Thermal Energy Production, mmbtu/hr       | 0.0       | 0.0       | 0.0       | 0.0       |
|                                  | Boiler (NG)      | Thermal Energy Production, mmbtu/hr       | 6.7       | 12.1      | 6.7       | 9.7       |
|                                  | Subtotal         | Thermal Energy Production, mmbtu/yr       | 58,928.0  | 105,661.9 | 58,928.0  | 85,309.0  |
| <b>Thermal Demand</b>            |                  |   |           |           |           |           |

|                                    |                    |   |           |            |           |            |
|------------------------------------|--------------------|---|-----------|------------|-----------|------------|
|                                    | Digester           | Thermal Energy Demand, mmbtu/hr           | -6.7      | 0.0        | -6.7      | -13.5      |
|                                    | Thermal Hydrolysis | Thermal Energy Demand, mmbtu/hr           | 0.0       | -12.1      | 0.0       | 0.0        |
|                                    | Subtotal           | Thermal Energy Demand, mmbtu/yr           | -58,928.0 | -105,662.0 | -58,928.0 | -117,856.1 |
| <b>Total Thermal Balance</b>       |                    |   |           |            |           |            |
|                                    | Solids Treatment   | Thermal Energy Total, mmbtu/yr            | 0.0       | 0.0        | 0.0       | -32,547.0  |
| <b>Electricity Consumption</b>     |                    |   |           |            |           |            |
|                                    | Digestion          | Electricity Load, kW                      | -119.4    | -119.4     | -119.4    | -133       |
|                                    | THP                | Electricity Load, kW                      | 0.0       | -223.8     | 0.0       | 0          |
|                                    | CHP                | Electricity Load, kW                      | 0.0       | 0.0        | 0.0       | 0          |
|                                    | Boiler             | Electricity Load, kW                      | -66.3     | -66.3      | -66.3     | -66        |
|                                    | Gas Upgrading      | Electricity Load, kW                      | -550.4    | -557.1     | -550.4    | -587       |
|                                    | Flare              | Electricity Load, kW                      | 0.0       | 0.0        | 0.0       | 0          |
|                                    | Predewatering      | Electricity Load, kW                      | 0.0       | -497.3     | 0.0       | 0          |
|                                    | Dewatering         | Electricity Load, kW                      | -746.0    | -746.0     | -746.0    | -746       |
|                                    | Subtotal           | Electricity Load, MWh/yr                  | -12,983.2 | -19,358.9  | -12,983.2 | -13,418.2  |
| <b>Electricity Production</b>      |                    |   |           |            |           |            |
|                                    | CHP                | Electricity Production, kW                | 0.0       | 0.0        | 0.0       | 0          |
|                                    | CHP                | Electricity Production, MWh/yr            | 0.0       | 0.0        | 0.0       | 0.0        |
| <b>Total Electricity Balance</b>   |                    |   |           |            |           |            |
|                                    | Solids Treatment   | Electricity Total, MWh/yr                 | -12,983.2 | -19,358.9  | -12,983.2 | -13,418.2  |
|                                    | Solids Treatment   | Electricity Export, kWh/yr                | 0.0       | 0.0        | 0.0       | 1.0        |
|                                    | Solids Treatment   | Electricity Import, kWh/yr                | 12,983.2  | 19,358.9   | 12,983.2  | 13,418.2   |
| <b>Process Water Usage</b>         |                    |   |           |            |           |            |
|                                    | THP                | Dilution Water, MG/yr                     | 0.0       | 57.1       | 0.0       | 0          |
| <b>Chemical Usage</b>              |                    |   |           |            |           |            |
|                                    | Predewatering      | Polymer Use, lb per year                  | 0.0       | 722,043.0  | 0.0       | 0          |
|                                    | Dewatering         | Polymer Use, lb per year                  | 816,156.7 | 771,898.5  | 816,156.7 | 758,712    |
| <b>Hauled Solids</b>               |                    |   |           |            |           |            |
|                                    | Hauling            | Average Hauled, wet tons/yr               | 96,696.5  | 69,809.0   | 96,696.5  | 89,891     |
|                                    | Hauling            | Dry Solids, %                             | 22.9%     | 30.0%      | 22.9%     | 22.9%      |
|                                    | Hauling            | Trucks per Day                            | 9.0       | 7.0        | 9.0       | 8          |
|                                    | Hauling            | Trucks per Year                           | 3,285.0   | 2,555.0    | 3,285.0   | 2,920.0    |
| <b>Brightwater Treatment Plant</b> |                    |   |           |            |           |            |
| <b>Solids Loading and Flows</b>    |                    |   |           |            |           |            |
|                                    | PS + WAS           | Average Digester Feed Load, dry lbs TS/hr | 3,912.9   | 3,912.9    | 3,912.9   | 3,912.9    |
|                                    | PS + WAS           | Average Digester Feed Load, %TS           | 5.8%      | 5.8%       | 5.8%      | 5.8%       |
|                                    | PS + WAS           | Average Digester Feed Load, %VS           | 89.9%     | 89.9%      | 89.9%     | 89.9%      |
| <b>Stabilization</b>               |                    |   |           |            |           |            |
|                                    | Digester           | Type                                      | MAD       | MAD        | MAD       | MAD        |
|                                    | Digester           | Biogas Production, mmbtu/hr               | 18.9      | 18.9       | 18.9      | 18.9       |
|                                    | Digester           | Biogas Production, SCFM                   | 571.5     | 571.5      | 571.5     | 571.5      |
|                                    | Digester           | Methane Production, SCFM                  | 342.9     | 342.9      | 342.9     | 342.9      |

|   |                    |                                     |           |           |           |           |           |
|---|--------------------|-------------------------------------|-----------|-----------|-----------|-----------|-----------|
| <b>Gas Utilization</b>                          |                    |                                     |           |           |           |           |           |
|   | Cogen              | Biogas Utilization, mmbtu/hr        | 0.0       | 0.0       | 0.0       | 0.0       | 0.0       |
|   | Cogen              | Methane Utilization, SCFM           | 0.0       | 0.0       | 0.0       | 0.0       | 0.0       |
|   | Boiler             | Biogas Utilization, mmbtu/hr        | -13.2     | -13.2     | -13.2     | -13.2     | -13.2     |
|   | Boiler             | Methane Utilization, SCFM           | -240.0    | -240.0    | -240.0    | -240.0    | -240.0    |
|   | Gas Upgrading      | Biogas Utilization, mmbtu/hr        | 0.0       | 0.0       | 0.0       | 0.0       | 0.0       |
|   | Gas Upgrading      | Methane Utilization, SCFM           | 0.0       | 0.0       | 0.0       | 0.0       | 0.0       |
|   | Flare              | Biogas Utilization, mmbtu/hr        | -5.7      | -5.7      | -5.7      | -5.7      | -5.7      |
|   | Flare              | Methane Utilization, SCFM           | -102.9    | -102.9    | -102.9    | -102.9    | -102.9    |
| <b>Thermal Supply</b>                           |                    |                                     |           |           |           |           |           |
|   | Cogen              | Thermal Energy Production, mmbtu/hr | 0.0       | 0.0       | 0.0       | 0.0       | 0.0       |
|   | Boiler             | Thermal Energy Production, mmbtu/hr | 11.2      | 11.2      | 11.2      | 11.2      | 11.2      |
|   | Subtotal           | Thermal Energy Production, mmbtu/yr | 98,296.4  | 98,296.4  | 98,296.4  | 98,296.4  | 98,296.4  |
| <b>Thermal Demand</b>                           |                    |                                     |           |           |           |           |           |
|   | Digester           | Thermal Energy Demand, mmbtu/hr     | -2.6      | -2.6      | -2.6      | -2.6      | -2.6      |
|   | Thermal Hydrolysis | Thermal Energy Demand, mmbtu/hr     | 0.0       | 0.0       | 0.0       | 0.0       | 0.0       |
|   | Pyrolysis          | Thermal Energy Demand, mmbtu/hr     | 0.0       | 0.0       | 0.0       | 0.0       | 0.0       |
|   | Subtotal           | Thermal Energy Demand, mmbtu/yr     | -22,427.9 | -22,427.9 | -22,427.9 | -22,427.9 | -22,427.9 |
| <b>Total Thermal Balance</b>                    |                    |                                     |           |           |           |           |           |
|   | Solids Treatment   | Thermal Energy Total, mmbtu/yr      | 75,868.5  | 75,868.5  | 75,868.5  | 75,868.5  | 75,868.5  |
| <b>Electricity Consumption</b>                  |                    |                                     |           |           |           |           |           |
|   | Digestion          | Electricity Load, kW                | -89.5     | -89.5     | -89.5     | -89.5     | -89.5     |
|   | CHP                | Electricity Load, kW                | 0.0       | 0.0       | 0.0       | 0.0       | 0.0       |
|   | Boiler             | Electricity Load, kW                | -33.2     | -33.2     | -33.2     | -33.2     | -33.2     |
|   | Gas Upgrading      | Electricity Load, kW                | 0.0       | 0.0       | 0.0       | 0.0       | 0.0       |
|   | Flare              | Electricity Load, kW                | 0.0       | 0.0       | 0.0       | 0.0       | 0.0       |
|   | Dewatering         | Electricity Load, kW                | -331.6    | -331.6    | -331.6    | -331.6    | -331.6    |
|   | Subtotal           | Electricity Load, MWh/yr            | -3,979.1  | -3,979.1  | -3,979.1  | -3,979.1  | -3,979.1  |
| <b>Electricity Production</b>                   |                    |                                     |           |           |           |           |           |
|   | CHP                | Electricity Production, kW          | 0.0       | 0.0       | 0.0       | 0.0       | 0.0       |
|   | CHP                | Electricity Production, MWh/yr      | 0.0       | 0.0       | 0.0       | 0.0       | 0.0       |
| <b>Total Electricity Balance</b>                |                    |                                     |           |           |           |           |           |
|   | Solids Treatment   | Electricity Total, MWh/yr           | -3,979.1  | -3,979.1  | -3,979.1  | -3,979.1  | -3,979.1  |
|   | Solids Treatment   | Electricity Export, kWh/yr          | 0.0       | 0.0       | 0.0       | 0.0       | 0.0       |
|   | Solids Treatment   | Electricity Import, kWh/yr          | 3,979.1   | 3,979.1   | 3,979.1   | 3,979.1   | 3,979.1   |
| <b>Chemical Usage</b>                           |                    |                                     |           |           |           |           |           |
|   | Predewatering      | Polymer Use, lb per year            | 0.0       | 0.0       | 0.0       | 0.0       | 0.0       |
|   | Dewatering         | Polymer Use, lb per year            | 271,319.5 | 271,319.5 | 271,319.5 | 271,319.5 | 271,319.5 |
| <b>Hauled Solids</b>                            |                    |                                     |           |           |           |           |           |
|   | Hauling            | Average Hauled, wet tons/yr         | 35,856.8  | 35,856.8  | 35,856.8  | 35,856.8  | 35,856.8  |
|   | Hauling            | Dry Solids, %                       | 20.0%     | 20.0%     | 20.0%     | 20.0%     | 20%       |
|   | Hauling            | Trucks per Day                      | 4.0       | 4.0       | 4.0       | 4.0       | 4.0       |
|   | Hauling            | Trucks per Year                     | 1,460.0   | 1,460.0   | 1,460.0   | 1,460.0   | 1,460.0   |
| <b>Off-Site Composting (Brightwater Solids)</b> |                    |                                     |           |           |           |           |           |



|  |                |   |  |  |         |  |         |
|--|----------------|---|--|--|---------|--|---------|
|  |                |   |  |  |         |  |         |
|  |                | <b>Solids Loading and Flows</b>                   |  |  |         |  |         |
|  | Dewatered Cake | Average Load, dry lbs TS/hr                       |  |  | 1,637   |  | 1,637   |
|  | Dewatered Cake | Average Load, %TS                                 |  |  | 20.0%   |  | 20%     |
|  | Dewatered Cake | Average, %VS                                      |  |  | 77.6%   |  | 78%     |
|  | Woodchips      | Average Load, dry lbs TS/hr                       |  |  | 5,519   |  | 5,519   |
|  | Woodchips      | Average Load, %TS                                 |  |  | 55.0%   |  | 55%     |
|  | Woodchips      | Average, %VS                                      |  |  | 95.0%   |  | 95%     |
|  | Screened Overs | Average Load, dry lbs TS/hr                       |  |  | 692     |  | 692     |
|  | Screened Overs | Average Load, %TS                                 |  |  | 55.0%   |  | 55%     |
|  | Screened Overs | Average, %VS                                      |  |  | 89.7%   |  | 90%     |
|  |                |   |  |  |         |  |         |
|  | Feed Mixture   | Average Load, dry lbs TS/hr                       |  |  | 7849    |  | 7,849   |
|  | Feed Mixture   | Average Load, %TS                                 |  |  | 40.3%   |  | 40%     |
|  | Feed Mixture   | Average, %VS                                      |  |  | 90.9%   |  | 91%     |
|  |                |   |  |  |         |  |         |
|  |                | <b>Electricity Consumption</b>                    |  |  |         |  |         |
|  | Composting     | Electricity Load, kW                              |  |  | -216    |  | -216    |
|  |                |   |  |  |         |  |         |
|  |                | <b>Fuel Consumption</b>                           |  |  |         |  |         |
|  | Composting     | Fuel Consumption (Diesel), gal/day                |  |  | 274     |  | 274     |
|  |                |   |  |  |         |  |         |
|  |                | <b>Hauling and Transportation</b>                 |  |  |         |  |         |
|  | Composting     | Finished Compost, wet tons/yr                     |  |  | 59,380  |  | 59,380  |
|  | Composting     | Dry Solids, %                                     |  |  | 50%     |  | 50%     |
|  | Composting     | Finished Compost, CY/yr                           |  |  | 145,512 |  | 145,512 |
|  | Commercial     | Compost, wet tons/yr                              |  |  | 41,566  |  | 41,566  |
|  | Residential    | Compost, wet tons/yr                              |  |  | 5,938   |  | 5,938   |
|  | Donated        | Compost, wet tons/yr                              |  |  | 11,876  |  | 11,876  |
|  |                |   |  |  |         |  |         |
|  |                | <b>Off-Site Soil Blending (West Point Solids)</b> |  |  |         |  |         |
|  |                |   |  |  |         |  |         |
|  |                | <b>Solids Loading and Flows</b>                   |  |  |         |  |         |
|  | Dewatered Cake | Average Load, dry lbs TS/hr                       |  |  | 3,899   |  | 3,899   |
|  | Dewatered Cake | Average Load, %TS                                 |  |  | 28.5%   |  | 29%     |
|  | Dewatered Cake | Average, %VS                                      |  |  | 57.7%   |  | 58%     |
|  | Sawdust        | Average Load, dry lbs TS/hr                       |  |  | 1,915   |  | 1,915   |
|  | Sawdust        | Average Load, %TS                                 |  |  | 60.0%   |  | 60%     |
|  | Sawdust        | Average, %VS                                      |  |  | 95.0%   |  | 95%     |
|  | Fine Sand      | Average Load, dry lbs TS/hr                       |  |  | 10,526  |  | 10,526  |
|  | Fine Sand      | Average Load, %TS                                 |  |  | 95.0%   |  | 95%     |
|  | Fine Sand      | Average, %VS                                      |  |  | 0.0%    |  | 0%      |
|  |                |   |  |  |         |  |         |
|  |                | <b>Electricity Consumption</b>                    |  |  |         |  |         |
|  | Soil Blending  | Electricity Load, kW                              |  |  | 0       |  | 0       |
|  |                |   |  |  |         |  |         |
|  |                | <b>Fuel Consumption</b>                           |  |  |         |  |         |
|  | Soil Blending  | Fuel Consumption (Diesel), gal/day                |  |  | 234     |  | 234     |
|  |                |   |  |  |         |  |         |
|  |                | <b>Hauling and Transportation</b>                 |  |  |         |  |         |
|  | Soil Blending  | Blended product, wet tons/yr                      |  |  | 122,429 |  | 122,429 |
|  | Soil Blending  | Dry Solids, %                                     |  |  | 58%     |  | 58%     |
|  | Soil Blending  | Blended product, CY/yr                            |  |  | 188,353 |  | 188,353 |

|  |                  |                                     |  |  |        |          |        |
|--|------------------|-------------------------------------|--|--|--------|----------|--------|
|  | Commercial       | Blended product, wet tons/yr        |  |  | 85,700 |          | 85,700 |
|  | Residential      | Blended product, wet tons/yr        |  |  | 24,486 |          | 24,486 |
|  | Donated          | Blended product, wet tons/yr        |  |  | 12,243 |          | 12,243 |
| <b>Off-Site Thermal Drying and Pyrolysis</b> |                  |                                     |  |  |        |          |        |
| <b>Solids Loading and Flows</b>              |                  |                                     |  |  |        |          |        |
|  | Dewatered Cake   | Average Load, dry lbs TS/hr         |  |  |        | 10,872   |        |
|  | Dewatered Cake   | Average Load, WT/yr                 |  |  |        | 193,448  |        |
|  | Dewatered Cake   | Average Load, %TS                   |  |  |        | 24.6%    |        |
|  | Dewatered Cake   | Average, %VS                        |  |  |        | 67.90%   |        |
| <b>Electricity Consumption</b>               |                  |                                     |  |  |        |          |        |
|  | Boiler           | Electricity Load, kW                |  |  |        | 66       |        |
|  | Thermal Drying   | Electricity Load, kW                |  |  |        | 3,367    |        |
|  | Pyrolysis        | Electricity Load, kW                |  |  |        | 1,870    |        |
|  | Subtotal         | Electricity Load, MWh/yr            |  |  |        | 46,456.3 |        |
| <b>Thermal Supply</b>                        |                  |                                     |  |  |        |          |        |
|  | Boiler           | NG Utilization, mmbtu/hr            |  |  |        | 30.72    |        |
|  | Boiler           | NG Utilization, SCFM                |  |  |        | 563      |        |
|  | Boiler           | Thermal Energy Production, mmbtu/hr |  |  |        | 26.12    |        |
|  | Thermal Drying   | Thermal Energy Production, mmbtu/hr |  |  |        | 0        |        |
|  | Pyrolysis        | Thermal Energy Production, mmbtu/hr |  |  |        | 21       |        |
|  | Subtotal         | Thermal Energy Production, mmbtu/yr |  |  |        | 415,294  |        |
| <b>Thermal Demand</b>                        |                  |                                     |  |  |        |          |        |
|  | Thermal Drying   | Thermal Energy Demand, mmbtu/hr     |  |  |        | -47      |        |
|  | Pyrolysis        | Thermal Energy Demand, mmbtu/hr     |  |  |        | 0        |        |
|  | Subtotal         | Thermal Energy Demand, mmbtu/yr     |  |  |        | -415,295 |        |
| <b>Total Thermal Balance</b>                 |                  |                                     |  |  |        |          |        |
|  | Solids Treatment | Thermal Energy Total, mmbtu/yr      |  |  |        | -0.2     |        |
| <b>Hauling and Transportation</b>            |                  |                                     |  |  |        |          |        |
|  | Hauling          | Average Hauled, wet tons/yr         |  |  |        | 22,920.1 |        |
|  | Hauling          | Dry Solids, %                       |  |  |        | 100.0%   |        |
|  | Hauling          | Solids Reduction                    |  |  |        | 51.9%    |        |
|  | Hauling          | Trucks per Day                      |  |  |        | 3.0      |        |
|  | Hauling          | Trucks per Year                     |  |  |        | 1,095.0  |        |

| GHG Emission Category | Emission Type   | Scenario 1     | Scenario 2     | Scenario 3     | Scenario 4     |
|-----------------------|---|----------------|----------------|----------------|----------------|
| Scope 1               | Fugitive Emissions [SC1FST]                           | 9,444          | 8,489          | 8,536          | 8,642          |
|                       | Fuel Combustion (Boilers, Machines) [SC1NGST, SC1MST] | 4,042          | 9,452          | 19,735         | 8,055          |
|                       | <b>Subtotal</b>                                       | <b>13,486</b>  | <b>17,941</b>  | <b>28,270</b>  | <b>16,697</b>  |
|                       | Subtotal (Check)                                      | 13,486         | 17,941         | 28,270         | 16,697         |
| Scope 2               | Electricity Usage [SC2E]                              | 104            | 112            | 104            | 112            |
|                       | Electricity Exported [SC2EC]                          | -100           | -107           | -100           | -107           |
|                       | <b>Subtotal</b>                                       | <b>4</b>       | <b>4</b>       | <b>4</b>       | <b>4</b>       |
|                       | Subtotal (Check)                                      | 4              | 4              | 4              | 4              |
| Scope 3               | Polymer Consumption [SC3PST]                          | 6,885          | 9,949          | 6,885          | 6,942          |
|                       | Fertilizer Offset [SC3FCST]                           | -9,766         | -9,694         | -6,029         | -9,638         |
|                       | Carbon Sequestration [SC3CCST]                        | -52,919        | -47,589        | -19,410        | -47,216        |
|                       | Natural Gas Use (Production) [SC3NGST]                | 1,068          | 1,915          | 5,213          | 1,546          |
|                       | Pipeline RNG [SC3BGST]                                | -31,501        | -31,884        | -31,501        | -33,585        |
|                       | Hauling, Transportation, Application [SC3TST]         | 8,467          | 4,433          | 924            | 4,803          |
|                       | <b>Subtotal</b>                                       | <b>-77,765</b> | <b>-72,871</b> | <b>-43,917</b> | <b>-77,148</b> |
|                       | Subtotal (Check)                                      | -77,765        | -72,871        | -43,917        | -77,148        |
|                       | <b>Total</b>  | <b>-64,276</b> | <b>-54,925</b> | <b>-15,643</b> | <b>-60,446</b> |

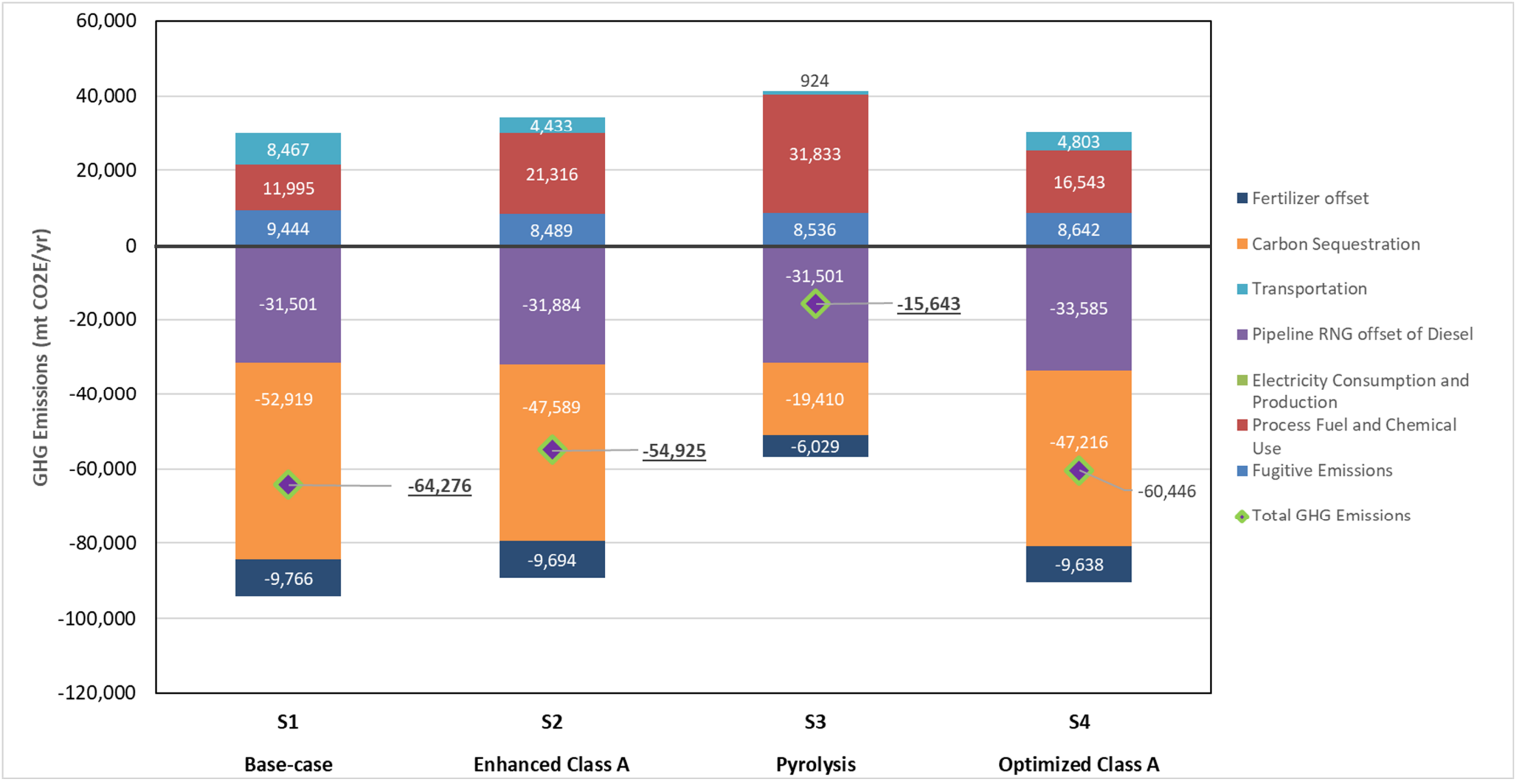



Scenario 1 - Baseline (100% Class B - MAD)

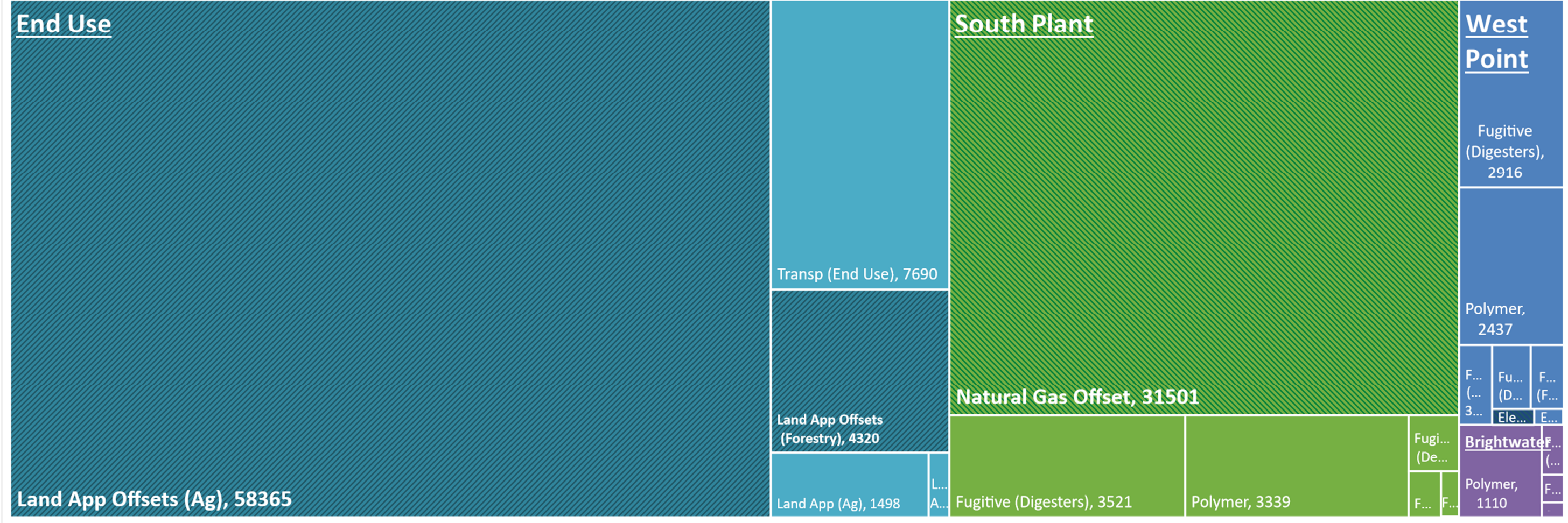



Scenario 2 - Enhanced Class A (TAD, THP, Soil Blending, and Composting)

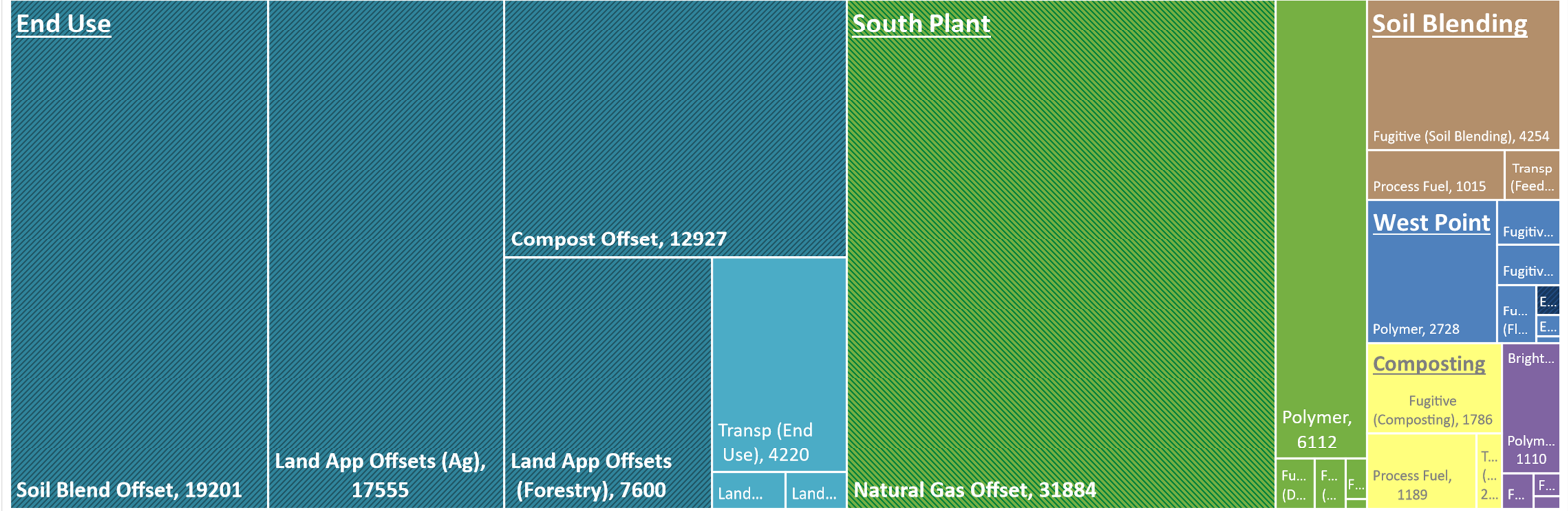



Scenario 3 - Off-site Thermal Drying + Pyrolysis

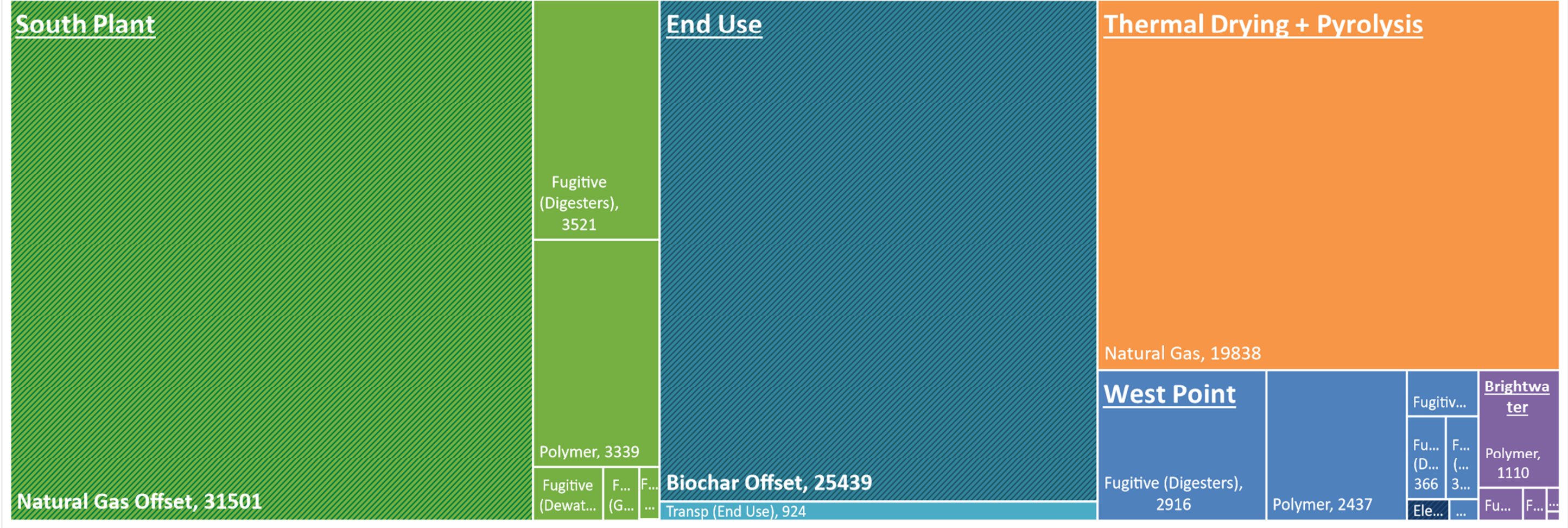



Scenario 4 - Optimized Class A (TAD, Soil Blending, and Composting)

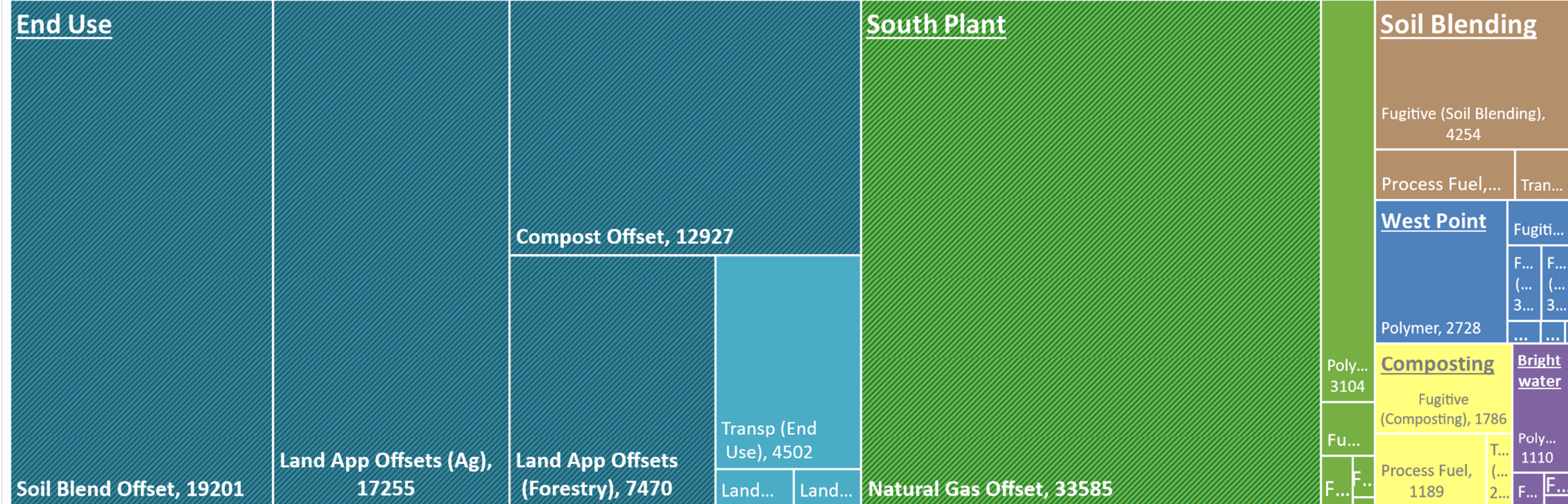

| GHG Emissions Inventory           |                  |  | Notes     | 1         | 2                | 3         | 4                 |
|-----------------------------------|------------------|--|-----------|-----------|------------------|-----------|-------------------|
| GHG Emissions Inventory           |                  |  |           | Base-case | Enhanced Class A | Pyrolysis | Optimized Class A |
| Element                           |                  |  |           | S1        | S2               | S3        | S4                |
| <b>West Point Treatment plant</b> |                  |  |           |           |                  |           |                   |
| <b>Electrical Emissions</b>       |                  |  |           |           |                  |           |                   |
|                                   | Solids Treatment | Electricity Production, MWh/yr   | 15,415    | 16,524    | 15,415           | 16,524    |                   |
|                                   | Solids Treatment | Electricity Sold, MWh/yr   | 15,415    | 16,524    | 15,415           | 16,524    |                   |
| C                                 | SC2EC            | Solids Treatment Emissions Offset, kg CO2e/yr                          | -100,199  | -107,404  | -100,199         | -107,404  |                   |
|                                   | Solids Treatment | Electricity Consumption, MWh/yr  | -10,523   | -11,748   | -10,523          | -11,748   |                   |
|                                   | Solids Treatment | Electricity Purchased, MWh/yr  | 10,523    | 11,748    | 10,523           | 11,748    |                   |
|                                   | SC2E             | Solids Treatment Emission, kg CO2e/yr                                  | 68,398    | 76,365    | 68,398           | 76,365    |                   |
|                                   | SC2EST           | Subtotal, kg CO2e/yr   | -31,801   | -31,039   | -31,801          | -31,039   |                   |
| <b>Natural Gas Emissions</b>      |                  |  |           |           |                  |           |                   |
|                                   | Solids Treatment | Thermal Production, MMBtu/yr   | 73,395    | 107,014   | 73,395           | 107,014   |                   |
|                                   | Solids Treatment | Thermal Consumption, MMBtu/yr  | -51,288   | -102,576  | -51,288          | -102,576  |                   |
|                                   | Solids Treatment | Thermal Balance, MMBtu/yr  | 22,107    | 4,438     | 22,107           | 4,438     |                   |
|                                   | Solids Treatment | External Natural Gas, scf/yr   | 0         | 0         | 0                | 0         |                   |
|                                   | SC1NG            | Combustion Emission, kg CO2e/yr  | 0         | 0         | 0                | 0         |                   |
|                                   | SC1NGST          | Subtotal, kg CO2e/yr   | 0         | 0         | 0                | 0         |                   |
|                                   | SC3NG            | Extraction/Production Emission, kg CO2e/yr                             | 0         | 0         | 0                | 0         |                   |
|                                   | SC3NGST          | Subtotal, kg CO2e/yr   | 0         | 0         | 0                | 0         |                   |
| <b>Chemical Emissions</b>         |                  |  |           |           |                  |           |                   |
|                                   | Dewatering       | Polymer Use, lb per yr   | 595,637   | 555,684   | 595,637          | 555,684   |                   |
|                                   | SC3P             | Dewatering Polymer Manufacturing, kg CO2e/yr                           | 2,436,696 | 2,727,903 | 2,436,696        | 2,727,903 |                   |
|                                   | SC3PST           | Subtotal, kg CO2e/yr   | 2,436,696 | 2,727,903 | 2,436,696        | 2,727,903 |                   |
| <b>Process Fugitive Emissions</b> |                  |  |           |           |                  |           |                   |
|                                   | SC1F             | Digestion Digester Floating Cover (WP = 5, SP = 4, BW = 0), kg CO2e/yr | 2,912,229 | 0         | 2,912,229        | 0         |                   |
|                                   | SC1F             | Digestion Digester Fixed Covers (WP = 0 SP = 1, BW = 3), kg CO2e/yr    | 3426      | 21838     | 3426             | 21,838    |                   |
|                                   | SC1F             | Dewatering Fugitive Emissions, kg CO2e/yr                              | 365,873   | 365,128   | 365,873          | 365,128   |                   |
|                                   | SC1F             | Cogen Fugitive Emissions, kg CO2e/yr                                   | 391,671   | 416,085   | 391,671          | 416,085   |                   |
|                                   | SC1F             | Boiler Fugitive Emissions, kg CO2e/yr                                  | 601       | 639       | 601              | 639       |                   |
|                                   | SC1F             | Flaring Fugitive Emissions, kg CO2e/yr                                 | 312,362   | 331,833   | 312,362          | 331,833   |                   |
|                                   | SC1FST           | Subtotal, kg CO2e/yr   | 3,986,162 | 1,135,523 | 3,986,162        | 1,135,523 |                   |
| <b>Hauling and Transportation</b> |                  |  |           |           |                  |           |                   |
|                                   | Hauling          | Average Hauled, wet tons/yr  | 64,224    | 59,916    | 64,224           | 59,916    |                   |
|                                   | Hauling          | Dry Solids, %  | 28.5%     | 28.5%     | 28.5%            | 0         |                   |
|                                   | Hauling          | Trucks per year  | 2,190     | 2,190     | 2,190            | 2,190     |                   |
|                                   | Hauling          | Off-site Processing, Total Miles                                       | 0         | 65,700    | 65,700           | 65,700    |                   |
|                                   | Hauling          | Fuel Usage Round Trip, gal/yr  | 0         | 11,965    | 11,965           | 11,965    |                   |
|                                   | SC3T             | Hauling Emissions, kg CO2e/yr  | 0         | 142,204   | 142,204          | 142,204   |                   |
|                                   | Hauling          | Eastern Washington, Total Miles  | 827,820   |           |                  |           |                   |
|                                   | Hauling          | Fuel Usage Round Trip, gal/yr  | 150,760   |           |                  |           |                   |
|                                   | SC3T             | Hauling Emissions, kg CO2e/yr  | 1,791,771 |           |                  |           |                   |
|                                   | Hauling          | Western Washington, Total Miles  | 15,330    |           |                  |           |                   |
|                                   | Hauling          | Fuel Usage Round Trip, gal/yr  | 53,572    |           |                  |           |                   |
|                                   | SC3T             | Hauling Emissions, kg CO2e/yr  | 636,704   |           |                  |           |                   |
|                                   | SC3TST           | Subtotal, kg CO2e/yr   | 2,428,474 | 142,204   | 142,204          | 142,204   |                   |

|         |                              |   |  |                |                           |                       |                           |
|---------|------------------------------|---|--|----------------|---------------------------|-----------------------|---------------------------|
|         | <b>Land Application</b>      |   |  |                |                           |                       |                           |
|         | Agriculture                  | KC Fuel for Agriculture (Eastern) Application, gal/yr |  | 18,519         |                           |                       |                           |
| SC3T    | Agriculture                  | Emissions, kg CO2e/yr                                 |  | 220,097        |                           |                       |                           |
|         | Forestry                     | KC Fuel for Forestry (Western) Application, gal/yr    |  | 2,826          |                           |                       |                           |
| SC3T    | Forestry                     | Emissions, kg CO2e/yr                                 |  | 33,585         |                           |                       |                           |
| SC3TST  | Subtotal, kg CO2e/yr         |   |  | 253,682        |                           |                       |                           |
| SC1F    | Agriculture                  | N2O and CH4 Emissions, kg CO2e/yr                     |  | 316,760        |                           |                       |                           |
| SC1F    | Forestry                     | N2O and CH4 Emissions, kg CO2e/yr                     |  | 35,196         |                           |                       |                           |
| SC1FST  | Subtotal, kg CO2e/yr         |   |  | 351,955        |                           |                       |                           |
|         |                              |   |  |                | To Off-site Soil Blending | To Off-site Pyrolysis | To Off-site Soil Blending |
|         | <b>Carbon Offsets</b>        |   |  |                |                           |                       |                           |
| SC3FC   | Agriculture                  | Nitrogen and Phosphorus Fertilizer Offset, kg CO2e/yr |  | -4,333,916     |                           |                       |                           |
| SC3FC   | Forestry                     | Nitrogen and Phosphorus Fertilizer Offset, kg CO2e/yr |  | 0              |                           |                       |                           |
| SC3FCST | Subtotal, kg CO2e/yr         |   |  | -4,333,916     |                           |                       |                           |
| SC3CC   | Agriculture                  | Land App Carbon Sequestration, kg CO2e/yr             |  | -18,680,671    |                           |                       |                           |
|         | Forestry                     | Land App Carbon Sequestration, kg CO2e/yr             |  | -1,660,504     |                           |                       |                           |
| SC3CCST | Subtotal, kg CO2e/yr         |   |  | -20,341,175    |                           |                       |                           |
|         | <b>WP GHG Plant Total</b>    |   |  |                |                           |                       |                           |
|         | Scope 1                      | CO2 Emissions, mt CO2e/yr                             |  | 4,338          | 1,136                     | 3,986                 | 1,136                     |
|         | Scope 2                      | CO2 Emissions, mt CO2e/yr                             |  | -32            | -31                       | -32                   | -31                       |
|         | Scope 3                      | CO2 Emissions, mt CO2e/yr                             |  | -19,556        | 2,870                     | 2,579                 | 2,870                     |
|         | <b>Plant Total</b>           | <b>CO2 Emissions, mt CO2e/yr</b>                      |  | <b>-15,250</b> | <b>3,975</b>              | <b>6,533</b>          | <b>3,975</b>              |
|         | <b>Plant Total Check</b>     | <b>CO2 Emissions, mt CO2e/yr</b>                      |  | <b>-15,250</b> | <b>3,975</b>              | <b>6,533</b>          | <b>3,975</b>              |
|         | <b>South Treatment plant</b> |   |  |                |                           |                       |                           |
|         | <b>Electrical Emissions</b>  |   |  |                |                           |                       |                           |
|         | Solids Treatment             | Electricity Production, MWh/yr                        |  | 0              | 0                         | 0                     | 0                         |
|         | Solids Treatment             | Electricity Sold, MWh/yr                              |  | 0              | 0                         | 0                     | 0                         |
| SC2E    | Solids Treatment             | Emissions Offset, kg CO2e/yr                          |  | 0              | 0                         | 0                     | 0                         |
|         | Solids Treatment             | Electricity Consumption, MWh/yr                       |  | -12,983        | -19,359                   | -12,983               | -13,418                   |
|         | Solids Treatment             | Electricity Purchased, MWh/yr                         |  | 12,983         | 19,359                    | 12,983                | 13,418                    |
| SC2E    | Solids Treatment             | Emission, kg CO2e/yr                                  |  | 0              | 0                         | 0                     | 0                         |
| SC2EST  | Subtotal, kg CO2e/yr         |   |  | 0              | 0                         | 0                     | 0                         |
|         | <b>Natural Gas Emissions</b> |   |  |                |                           |                       |                           |
|         | Solids Treatment             | Thermal Production, MMBtu/yr                          |  | 58,928         | 105,662                   | 58,928                | 85,309                    |
|         | Solids Treatment             | Thermal Consumption, MMBtu/yr                         |  | -58,928        | -105,662                  | -58,928               | -117,856                  |
|         | Solids Treatment             | External Natural Gas, scf/yr                          |  | 76,267,424     | 136,752,625               | 76,267,424            | 110,410,948               |
| SC1NG   | Combustion                   | Emission, kg CO2e/yr                                  |  | 4,042,173      | 7,247,889                 | 4,042,173             | 5,851,780                 |
| SC1NGST | Subtotal, kg CO2e/yr         |   |  | 4,042,173      | 7,247,889                 | 4,042,173             | 5,851,780                 |
| SC3NG   | Extraction/Production        | Emission, kg CO2e/yr                                  |  | 1,067,744      | 1,914,537                 | 1,067,744             | 1,545,753                 |
| SC3NGST | Subtotal, kg CO2e/yr         |   |  | 1,067,744      | 1,914,537                 | 1,067,744             | 1,545,753                 |
|         | Solids Treatment             | Renewable Natural Gas Export, scf/yr                  |  | 367,809,910    | 372,282,694               | 367,809,910           | 392,134,504               |
|         | Solids Treatment             | Gallon of Gasoline Equiv, gal/yr                      |  | 2,913,054      | 2,948,479                 | 2,913,054             | 3,105,705                 |
|         | Solids Treatment             | RNG as Diesel Equiv, gal/yr                           |  | 2,650,525      | 2,682,757                 | 2,650,525             | 2,825,814                 |
| SC3BG   | Solids Treatment             | Emission, kg CO2e/yr                                  |  | -31,501,228    | -31,884,301               | -31,501,228           | -33,584,517               |
| SC3BGST | Subtotal, kg CO2e/yr         |   |  | -31,501,228    | -31,884,301               | -31,501,228           | -33,584,517               |
|         | <b>Chemical Emissions</b>    |   |  |                |                           |                       |                           |
|         | Pre-Dewatering               | Polymer Use, lb per yr                                |  | 0              | 722,043                   | 0                     | 0                         |
| SC3P    | Pre-Dewatering               | Polymer Manufacturing, kg CO2e/yr                     |  | 0              | 2,953,812                 | 0                     | 0                         |
|         | Dewatering                   | Polymer Use, lb per yr                                |  | 816,157        | 771,899                   | 816,157               | 758,712                   |
| SC3P    | Dewatering                   | Polymer Manufacturing, kg CO2e/yr                     |  | 3,338,823      | 3,157,767                 | 3,338,823             | 3,103,823                 |



|  |                                    |                          |  |  |                |                |                       |                |
|--|------------------------------------|--------------------------|--|--|----------------|----------------|-----------------------|----------------|
|  | SC3PST                             |                          | Subtotal, kg CO2e/yr   |  | 3,338,823      | 6,111,579      | 3,338,823             | 3,103,823      |
|  | <b>Process Fugitive Emissions</b>  |                          |  |  |                |                |                       |                |
|  | SC1F                               | Digestion                | Digester Floating Cover (KP = 5, SP = 4, BW = 0), kg CO2e/yr |  | 3,515,991      | 0              | 3,515,991             | 0              |
|  | SC1F                               | Digestion                | Digester Fixed Covers (KP = 0, SP = 1, BW = 3), kg CO2e/yr   |  | 5,171          | 26,167         | 5,171                 | 27,563         |
|  | SC1F                               | Dewatering               | Fugitive Emissions, kg CO2e/yr                               |  | 420,225        | 279,021        | 420,225               | 419,307        |
|  | SC1F                               | Cogen                    | Fugitive Emissions, kg CO2e/yr                               |  | 0              | 0              | 0                     | 0              |
|  | SC1F                               | Boiler                   | Fugitive Emissions, kg CO2e/yr                               |  | 2,038          | 3,655          | 2,038                 | 2,951          |
|  | SC1F                               | Gas Upgrading            | Fugitive Emissions, kg CO2e/yr                               |  | 218,457        | 221,113        | 218,457               | 232,904        |
|  | SC1F                               | Flaring                  | Fugitive Emissions, kg CO2e/yr                               |  | 120,216        | 121,678        | 120,216               | 128,166        |
|  | SC1FST                             |                          | Subtotal, kg CO2e/yr   |  | 4,282,097      | 651,635        | 4,282,097             | 810,891        |
|  | <b>Hauling and Transportation</b>  |                          |  |  |                |                |                       |                |
|  |                                    | Hauling                  | Average Hauled, wet tons/yr                                  |  | 96,696         | 69,809         | 96,696                | 89,891         |
|  |                                    | Hauling                  | Dry Solids, %  |  | 22.9%          | 30.0%          | 22.9%                 | 23%            |
|  |                                    | Hauling                  | Trucks per year  |  | 3,285          | 2,555          | 3,285                 | 2920           |
|  |                                    | Hauling                  | Off-site Processing, Total Miles                             |  | 0              | 0              | 98,550                | 0              |
|  |                                    | Hauling                  | Fuel Usage Round Trip, gal/yr                                |  | 0              | 0              | 17,948                | 0              |
|  | SC3T                               | Hauling                  | Emissions, kg CO2e/yr  |  | 0              | 0              | 213,306               | 0              |
|  |                                    | Hauling                  | Eastern Washington, Total Miles                              |  | 1,241,730      | 643,860        | To Off-site Pyrolysis | 735,840        |
|  |                                    | Hauling                  | Fuel Usage Round Trip, gal/yr                                |  | 226,140        | 117,258        |                       | 134,009        |
|  | SC3T                               | Hauling                  | Emissions, kg CO2e/yr  |  | 2,687,656      | 1,393,600      |                       | 1,592,685      |
|  |                                    | Hauling                  | Western Washington, Total Miles                              |  | 22,995         | 71,540         |                       | 81,760         |
|  |                                    | Hauling                  | Fuel Usage Round Trip, gal/yr                                |  | 80,359         | 48,799         |                       | 55,770         |
|  | SC3T                               | Hauling                  | Emissions, kg CO2e/yr  |  | 955,055        | 579,967        |                       | 662,820        |
|  | SC3TST                             |                          | Subtotal, kg CO2e/yr   |  | 3,642,712      | 1,973,567      | 213,306               | 2,255,505      |
|  | <b>Land Application</b>            |                          |  |  |                |                |                       |                |
|  |                                    | Agriculture              | KC Fuel for Agriculture (Eastern) Application, gal/yr        |  | 27,882         | 13,420         | To Off-site Pyrolysis | 17,280         |
|  | SC3T                               | Agriculture              | Emissions, kg CO2e/yr  |  | 331,379        | 159,491        |                       | 205,370        |
|  |                                    | Forestry                 | KC Fuel for Forestry (Western) Application, gal/yr           |  | 4,255          | 12,286         |                       | 15,821         |
|  | SC3T                               | Forestry                 | Emissions, kg CO2e/yr  |  | 50,566         | 146,023        |                       | 188,028        |
|  | SC3TST                             |                          | Subtotal, kg CO2e/yr   |  | 381,945        | 305,513        |                       | 393,398        |
|  | SC1F                               | Agriculture              | N2O and CH4 Emissions, kg CO2e/yr                            |  | 383,206        | 161,078        |                       | 158,326        |
|  | SC1F                               | Forestry                 | N2O and CH4 Emissions, kg CO2e/yr                            |  | 42,578         | 241,617        | To Off-site Pyrolysis | 237,489        |
|  | SC1FST                             |                          | Subtotal, kg CO2e/yr   |  | 425,784        | 402,695        |                       | 395,816        |
|  | <b>Carbon Offsets</b>              |                          |  |  |                |                |                       |                |
|  | SC3FC                              | Agriculture              | Nitrogen and Phosphorus Fertilizer Offset, kg CO2e/yr        |  | -5,243,033     | -3,305,811     |                       | -3,249,338     |
|  | SC3FC                              | Forestry                 | Nitrogen and Phosphorus Fertilizer Offset, kg CO2e/yr        |  | 0              | 0              |                       | 0              |
|  | SC3FCST                            |                          | Subtotal, kg CO2e/yr   |  | -5,243,033     | -3,305,811     |                       | -3,249,338     |
|  | SC3CC                              | Agriculture              | Land App Carbon Sequestration, kg CO2e/yr                    |  | -22,599,279    | -14,249,184    |                       | -14,005,769    |
|  | SC3CC                              | Forestry                 | Land App Carbon Sequestration, kg CO2e/yr                    |  | -2,008,825     | -7,599,565     |                       | -7,469,743     |
|  | SC3CCST                            |                          | Subtotal, kg CO2e/yr   |  | -24,608,104    | -21,848,749    |                       | -21,475,512    |
|  | <b>SP GHG Plant Total</b>          |                          |  |  |                |                |                       |                |
|  |                                    | Scope 1                  | CO2 Emissions, mt CO2e/yr                                    |  | 8,750          | 8,302          | 8,324                 | 7,058          |
|  |                                    | Scope 2                  | CO2 Emissions, mt CO2e/yr                                    |  | 0              | 0              | 0                     | 0              |
|  |                                    | Scope 3                  | CO2 Emissions, mt CO2e/yr                                    |  | -52,921        | -46,734        | -26,881               | -51,011        |
|  |                                    | <b>Plant Total</b>       | <b>CO2 Emissions, mt CO2e/yr</b>                             |  | <b>-44,171</b> | <b>-38,431</b> | <b>-18,557</b>        | <b>-43,952</b> |
|  |                                    | <b>Plant Total Check</b> | <b>CO2 Emissions, mt CO2e/yr</b>                             |  | <b>-44,171</b> | <b>-38,431</b> | <b>-18,557</b>        | <b>-43,952</b> |
|  | <b>Brightwater Treatment Plant</b> |                          |  |  |                |                |                       |                |
|  |                                    | Electrical Emissions     |  |  |                |                |                       |                |

|                                   |                       |  |           |                        |                       |                        |
|-----------------------------------|-----------------------|--|-----------|------------------------|-----------------------|------------------------|
|                                   | Solids Treatment      | Electricity Production, MWh/yr                               | 0         | 0                      | 0                     | 0                      |
|                                   | Solids Treatment      | Electricity Sold, MWh/yr                                     | 0         | 0                      | 0                     | 0                      |
| SC2E                              | Solids Treatment      | Emissions Offset, kg CO2e/yr                                 | 0         | 0                      | 0                     | 0                      |
|                                   | Solids Treatment      | Electricity Consumption, MWh/yr                              | -3,979    | -3,979                 | -3,979                | -3,979                 |
|                                   | Solids Treatment      | Electricity Purchased, MWh/yr                                | 3,979     | 3,979                  | 3,979                 | 3,979                  |
| SC2E                              | Solids Treatment      | Emission, kg CO2e/yr   | 35,414    | 35,414                 | 35,414                | 35,414                 |
| SC2EST                            |                       | Subtotal, kg CO2e/yr   | 35,414    | 35,414                 | 35,414                | 35,414                 |
| <b>Natural Gas Emissions</b>      |                       |  |           |                        |                       |                        |
|                                   | Solids Treatment      | Thermal Production, MMBtu/yr                                 | 98,296    | 98,296                 | 98,296                | 98,296                 |
|                                   | Solids Treatment      | Thermal Consumption, MMBtu/yr                                | -22,428   | -22,428                | -22,428               | -22,428                |
|                                   | Solids Treatment      | Thermal Balance, MMBtu/yr                                    | 75,868    | 75,868                 | 75,868                | 75,868                 |
|                                   | Solids Treatment      | External Natural Gas, scf/yr                                 | 0         | 0                      | 0                     | 0                      |
| SC1NG                             | Combustion            | Emission, kg CO2e/yr   | 0         | 0                      | 0                     | 0                      |
| SC1NGST                           |                       | Subtotal, kg CO2e/yr   | 0         | 0                      | 0                     | 0                      |
| SC3NG                             | Extraction/Production | Emission, kg CO2e/yr   | 0         | 0                      | 0                     | 0                      |
| SC3NGST                           |                       | Subtotal, kg CO2e/yr   | 0         | 0                      | 0                     | 0                      |
| <b>Chemical Emissions</b>         |                       |  |           |                        |                       |                        |
|                                   | Pre-Dewatering        | Polymer Use, lb per yr                                       | 0         | 0                      | 0                     | 0                      |
| SC3P                              | Pre-Dewatering        | Polymer Manufacturing, kg CO2e/yr                            | 0         | 0                      | 0                     | 0                      |
|                                   | Dewatering            | Polymer Use, lb per yr                                       | 271,320   | 271,320                | 271,320               | 271,320                |
| SC3P                              | Dewatering            | Polymer Manufacturing, kg CO2e/yr                            | 1,109,944 | 1,109,944              | 1,109,944             | 1,109,944              |
| SC3PST                            |                       | Subtotal, kg CO2e/yr   | 1,109,944 | 1,109,944              | 1,109,944             | 1,109,944              |
| <b>Process Fugitive Emissions</b> |                       |  |           |                        |                       |                        |
| SC1F                              | Digestion             | Digester Floating Cover (KP = 5, SP = 4, BW = 0), kg CO2e/yr | 0         | 0                      | 0                     | 0                      |
| SC1F                              | Digestion             | Digester Fixed Covers (KP = 0, SP = 1, BW = 3), kg CO2e/yr   | 9,634     | 9,634                  | 9,634                 | 9,634                  |
| SC1F                              | Dewatering            | Fugitive Emissions, kg CO2e/yr                               | 159,970   | 159,970                | 159,970               | 159,970                |
| SC1F                              | Cogen                 | Fugitive Emissions, kg CO2e/yr                               | 0         | 0                      | 0                     | 0                      |
| SC1F                              | Boiler                | Fugitive Emissions, kg CO2e/yr                               | 3,372     | 3,372                  | 3,372                 | 3,372                  |
| SC1F                              | Gas Upgrading         | Fugitive Emissions, kg CO2e/yr                               | 0         | 0                      | 0                     | 0                      |
| SC1F                              | Flaring               | Fugitive Emissions, kg CO2e/yr                               | 86,703    | 86,703                 | 86,703                | 86,703                 |
| SC1FST                            |                       | Subtotal, kg CO2e/yr   | 259,679   | 259,679                | 259,679               | 259,679                |
| <b>Hauling and Transportation</b> |                       |  |           |                        |                       |                        |
|                                   | Hauling               | Average Hauled, wet tons/yr                                  | 35,857    | 35,857                 | 35,857                | 35,857                 |
|                                   | Hauling               | Dry Solids, %  | 20.0%     | 20.0%                  | 20.0%                 | 20.0%                  |
|                                   | Hauling               | Trucks per year  | 1,460     | 1,460                  | 1,460                 | 1,460                  |
|                                   | Hauling               | Off-site Processing, Total Miles                             | 0         | 43,800                 | 43,800                | 43,800                 |
|                                   | Hauling               | Fuel Usage Round Trip, gal/yr                                | 0         | 7,977                  | 7,977                 | 7,977                  |
| SC3T                              | Hauling               | Emissions, kg CO2e/yr  | 0         | 94,803                 | 94,803                | 94,803                 |
|                                   | Hauling               | Eastern Washington, Total Miles                              | 551,880   | To Off-site Composting | To Off-site Pyrolysis | To Off-site Composting |
|                                   | Hauling               | Fuel Usage Round Trip, gal/yr                                | 100,507   |                        |                       |                        |
| SC3T                              | Hauling               | Emissions, kg CO2e/yr  | 1,194,514 |                        |                       |                        |
|                                   | Hauling               | Western Washington, Total Miles                              | 10,220    |                        |                       |                        |
|                                   | Hauling               | Fuel Usage Round Trip, gal/yr                                | 35,715    |                        |                       |                        |
| SC3T                              | Hauling               | Emissions, kg CO2e/yr  | 424,469   |                        |                       |                        |
| SC3TST                            |                       | Subtotal, kg CO2e/yr   | 1,618,983 |                        |                       |                        |
| <b>Land Application</b>           |                       |  |           |                        |                       |                        |
|                                   | Agriculture           | KC Fuel for Agriculture (Eastern) Application, gal/yr        | 10,339    |                        |                       |                        |
| SC3T                              | Agriculture           | Emissions, kg CO2e/yr  | 122,881   |                        |                       |                        |
|                                   | Forestry              | KC Fuel for Forestry (Western) Application, gal/yr           | 1,578     |                        |                       |                        |
| SC3T                              | Forestry              | Emissions, kg CO2e/yr  | 18,751    |                        |                       |                        |
| SC3TST                            |                       | Subtotal, kg CO2e/yr   | 141,632   |                        |                       |                        |

|         |                                   |   |  |            |                        |                       |                        |
|---------|-----------------------------------|---|--|------------|------------------------|-----------------------|------------------------|
| SC1F    | Agriculture                       | N2O and CH4 Emissions, kg CO2e/yr                     |  | 124,104    |                        |                       |                        |
| SC1F    | Forestry                          | N2O and CH4 Emissions, kg CO2e/yr                     |  | 13,789     |                        |                       |                        |
| SC1FST  |                                   | Subtotal, kg CO2e/yr                                  |  | 137,894    |                        |                       |                        |
|         |                                   |   |  |            | To Off-site Composting | To Off-site Pyrolysis | To Off-site Composting |
|         | Carbon Offsets                    |   |  |            |                        |                       |                        |
| SC3FC   | Agriculture                       | Nitrogen and Phosphorus Fertilizer Offset, kg CO2e/yr |  | -188,667   |                        |                       |                        |
| SC3FC   | Forestry                          | Nitrogen and Phosphorus Fertilizer Offset, kg CO2e/yr |  | 0          |                        |                       |                        |
| SC3FCST |                                   | Subtotal, kg CO2e/yr                                  |  | -188,667   |                        |                       |                        |
| SC3CC   | Agriculture                       | Land App Carbon Sequestration, kg CO2e/yr             |  | -7,318,972 |                        |                       |                        |
| SC3CC   | Forestry                          | Land App Carbon Sequestration, kg CO2e/yr             |  | -650,575   |                        |                       |                        |
| SC3CCST |                                   | Subtotal, kg CO2e/yr                                  |  | -7,969,547 |                        |                       |                        |
|         |                                   |   |  |            |                        |                       |                        |
|         | <b>SP GHG Plant Total</b>         |   |  |            |                        |                       |                        |
|         | Scope 1                           | CO2 Emissions, mt CO2e/yr                             |  | 398        | 260                    | 260                   | 260                    |
|         | Scope 2                           | CO2 Emissions, mt CO2e/yr                             |  | 35         | 35                     | 35                    | 35                     |
|         | Scope 3                           | CO2 Emissions, mt CO2e/yr                             |  | -5,288     | 1,205                  | 1,205                 | 1,205                  |
|         | Plant Total                       | CO2 Emissions, mt CO2e/yr                             |  | -4,855     | 1,500                  | 1,500                 | 1,500                  |
|         | Plant Total Check                 | CO2 Emissions, mt CO2e/yr                             |  | -4,855     | 1,500                  | 1,500                 | 1,500                  |
|         |                                   |   |  |            |                        |                       |                        |
|         |                                   |   |  |            |                        |                       |                        |
|         | <b>Off-Site Composting</b>        |   |  |            |                        |                       |                        |
|         |                                   |   |  |            |                        |                       |                        |
|         | <b>Hauling and Transportation</b> |   |  |            |                        |                       |                        |
|         | Hauling                           | Feedstock (Sawdust), wet tons/yr                      |  |            | 24,175                 |                       | 24,175                 |
|         | Hauling                           | Large Trucks per year                                 |  |            | 779.8                  |                       | 780                    |
|         | Hauling                           | Feedstock to Off-site Processing, Total Miles         |  |            | 124,773                |                       | 124,773                |
|         | Hauling                           | Fuel (Diesel) Usage Round Trip, gal/yr                |  |            | 22,723                 |                       | 22,723                 |
| SC3T    | Hauling                           | Emissions, kg CO2e/yr                                 |  |            | 270,065                |                       | 270,065                |
|         | Hauling                           | Commercial/Donation Usage, wet tons/yr                |  |            | 47,504                 |                       | 47,504                 |
|         | Hauling                           | Medium Trucks per year                                |  |            | 7,038                  |                       | 7,038                  |
|         | Hauling                           | Off-site Processing to Customer, Total Miles          |  |            | 175,941                |                       | 175,941                |
|         | Hauling                           | Fuel (Diesel) Usage Round Trip, gal/yr                |  |            | 20,900                 |                       | 20,900                 |
| SC3T    | Hauling                           | Emissions, kg CO2e/yr                                 |  |            | 248,400                |                       | 248,400                |
|         | Transportation                    | Residential Usage, wet tons/yr                        |  |            | 11,876                 |                       | 11,876                 |
|         | Transportation                    | Vehicles per year                                     |  |            | 42,754                 |                       | 42,754                 |
|         | Transportation                    | Fuel (Gasoline) Usage Round Trip, gal/yr              |  |            | 42,754                 |                       | 42,754                 |
| SC3T    | Transportation                    | Emissions, kg CO2e/yr                                 |  |            | 453,104                |                       | 453,104                |
| SC3TST  |                                   | Subtotal, kg CO2e/yr                                  |  |            | 971,568                |                       | 971,568                |
|         |                                   |   |  |            |                        |                       |                        |
|         | <b>Fuel Emissions</b>             |   |  |            |                        |                       |                        |
|         | Composting                        | Machinery Fuel Consumption (Diesel), gal/day          |  |            | 274                    |                       | 274                    |
| SC1M    | Composting                        | Emissions, kg CO2e/yr                                 |  |            | 1,188,609              |                       | 1,188,609              |
| SC1MST  |                                   | Subtotal, kg CO2e/yr                                  |  |            | 1,188,609              |                       | 1,188,609              |
|         |                                   |   |  |            |                        |                       |                        |
|         | <b>Electrical Emissions</b>       |   |  |            |                        |                       |                        |
|         | Composting                        | Electricity Consumption, MWh/yr                       |  |            | -1,888                 |                       | -1,888                 |
|         | Composting                        | Electricity Purchased, MWh/yr                         |  |            | 1,888                  |                       | 1,888                  |
| SC2E    | Composting                        | Emission, kg CO2e/yr                                  |  |            | 0                      |                       | 0                      |
| SC2EST  |                                   | Subtotal, kg CO2e/yr                                  |  |            | 0                      |                       | 0                      |
|         |                                   |   |  |            |                        |                       |                        |
|         | <b>Process Fugitive Emissions</b> |   |  |            |                        |                       |                        |
|         | Composting                        | Biosolids, dry lb/hr                                  |  |            | 1,637.3                |                       | 1,637                  |
| SC1F    | Composting                        | N2O Emissions, kg CO2e/yr                             |  |            | 691,058.6              |                       | 691,059                |
| SC1F    | Composting                        | CH4 Emissions, kg CO2e/yr                             |  |            | 1,095,262.7            |                       | 1,095,263              |
| SC1FST  |                                   | Subtotal, kg CO2e/yr                                  |  |            | 1,786,321.3            |                       | 1,786,321              |

|  |                               |                                   |   |  |  |               |               |  |
|--|-------------------------------|-----------------------------------|---|--|--|---------------|---------------|--|
|  | <b>Carbon Offsets</b>         |                                   |   |  |  |               |               |  |
|  | SC3FC                         | Land Application                  | Nitrogen and Phosphorus Fertilizer Offset, kg CO2e/yr |  |  | -1,886,283.6  | -1,886,284    |  |
|  | SC3FCST                       |                                   | Subtotal, kg CO2e/yr                                  |  |  | -1,886,283.6  | -1,886,284    |  |
|  | SC3CC                         | Land Application                  | Land App Carbon Sequestration, kg CO2e/yr             |  |  | -11,040,853   | -11,040,853   |  |
|  | SC3CCST                       |                                   | Subtotal, kg CO2e/yr                                  |  |  | -11,040,853   | -11,040,853   |  |
|  |                               | Scope 1                           | CO2 Emissions, mt CO2e/yr                             |  |  | 2,975         | 2,975         |  |
|  |                               | Scope 2                           | CO2 Emissions, mt CO2e/yr                             |  |  | 0             | 0             |  |
|  |                               | Scope 3                           | CO2 Emissions, mt CO2e/yr                             |  |  | -11,956       | -11,956       |  |
|  |                               | <b>Plant Total</b>                | <b>CO2 Emissions, mt CO2e/yr</b>                      |  |  | <b>-8,981</b> | <b>-8,981</b> |  |
|  |                               | <b>Plant Total Check</b>          | <b>CO2 Emissions, mt CO2e/yr</b>                      |  |  | <b>-8,981</b> | <b>-8,981</b> |  |
|  |                               |                                   |   |  |  |               |               |  |
|  |                               |                                   |   |  |  |               |               |  |
|  | <b>Off-Site Soil Blending</b> |                                   |   |  |  |               |               |  |
|  |                               |                                   |   |  |  |               |               |  |
|  |                               | <b>Hauling and Transportation</b> |   |  |  |               |               |  |
|  |                               | Hauling                           | Feedstock (Sawdust), wet tons/yr                      |  |  | 13,980        | 13,980        |  |
|  |                               | Hauling                           | Large Trucks per year                                 |  |  | 451.0         | 451           |  |
|  |                               | Hauling                           | Feedstock to Off-site Processing, Total Miles         |  |  | 72,157        | 72,157        |  |
|  |                               | Hauling                           | Fuel (Diesel) Usage Round Trip, gal/yr                |  |  | 13,141        | 13,141        |  |
|  | SC3T                          | Hauling                           | Emissions, kg CO2e/yr                                 |  |  | 156,181       | 156,181       |  |
|  |                               | Hauling                           | Feedstock (Fine Sand), wet tons/yr                    |  |  | 48,532        | 48,532        |  |
|  |                               | Hauling                           | Large Trucks per year                                 |  |  | 1,565.6       | 1,566         |  |
|  |                               | Hauling                           | Feedstock to Off-site Processing, Total Miles         |  |  | 117,417       | 117,417       |  |
|  |                               | Hauling                           | Fuel (Diesel) Usage Round Trip, gal/yr                |  |  | 21,384        | 21,384        |  |
|  | SC3T                          | Hauling                           | Emissions, kg CO2e/yr                                 |  |  | 254,142       | 254,142       |  |
|  |                               | Hauling                           | Commercial/Donation Usage, wet tons/yr                |  |  | 97,943        | 97,943        |  |
|  |                               | Hauling                           | Medium Trucks per year                                |  |  | 8,371         | 8,371         |  |
|  |                               | Hauling                           | Off-site Processing to Customer, Total Miles          |  |  | 209,281       | 209,281       |  |
|  |                               | Hauling                           | Fuel (Diesel) Usage Round Trip, gal/yr                |  |  | 21,048        | 21,048        |  |
|  | SC3T                          | Hauling                           | Emissions, kg CO2e/yr                                 |  |  | 250,152       | 250,152       |  |
|  |                               | Transportation                    | Residential Usage, wet tons/yr                        |  |  | 24,486        | 24,486        |  |
|  |                               | Transportation                    | Vehicles per year                                     |  |  | 50,855        | 50,855        |  |
|  |                               | Transportation                    | Fuel (Gasoline) Usage Round Trip, gal/yr              |  |  | 50,855        | 50,855        |  |
|  | SC3T                          | Transportation                    | Emissions, kg CO2e/yr                                 |  |  | 538,963       | 538,963       |  |
|  | SC3TST                        |                                   | Subtotal, kg CO2e/yr                                  |  |  | 945,296       | 945,296       |  |
|  |                               |                                   |   |  |  |               |               |  |
|  |                               | <b>Fuel Emissions</b>             |   |  |  |               |               |  |
|  |                               | Soil Blending                     | Machinery Fuel Consumption (Diesel), gal/day          |  |  | 234           | 234           |  |
|  | SC1M                          | Soil Blending                     | Emissions, kg CO2e/yr                                 |  |  | 1,015,089     | 1,015,089     |  |
|  | SC1MST                        |                                   | Subtotal, kg CO2e/yr                                  |  |  | 1,015,089     | 1,015,089     |  |
|  |                               |                                   |   |  |  |               |               |  |
|  |                               | <b>Electrical Emissions</b>       |   |  |  |               |               |  |
|  |                               | Soil Blending                     | Electricity Consumption, MWh/yr                       |  |  | 0             | 0             |  |
|  |                               | Soil Blending                     | Electricity Purchased, MWh/yr                         |  |  | 0             | 0             |  |
|  | SC2E                          | Soil Blending                     | Emission, kg CO2e/yr                                  |  |  | 0             | 0             |  |
|  | SC2EST                        |                                   | Subtotal, kg CO2e/yr                                  |  |  | 0             | 0             |  |
|  |                               |                                   |   |  |  |               |               |  |
|  |                               | <b>Process Fugitive Emissions</b> |   |  |  |               |               |  |
|  |                               | Soil Blending                     | Biosolids, dry lb/hr                                  |  |  | 3,898.7       | 3,899         |  |
|  | SC1F                          | Soil Blending                     | N2O Emissions, kg CO2e/yr                             |  |  | 1,645,521.9   | 1,645,522     |  |
|  | SC1F                          | Soil Blending                     | CH4 Emissions, kg CO2e/yr                             |  |  | 2,607,996.9   | 2,607,997     |  |
|  | SC1FST                        |                                   | Subtotal, kg CO2e/yr                                  |  |  | 4,253,518.8   | 4,253,519     |  |
|  |                               |                                   |   |  |  |               |               |  |
|  |                               | <b>Carbon Offsets</b>             |   |  |  |               |               |  |
|  | SC3FC                         | Land Application                  | Nitrogen and Phosphorus Fertilizer Offset, kg CO2e/yr |  |  | -4,501,899.4  | -4,501,899    |  |



|  |         |                       |   |  |  |              |              |             |
|--|---------|-----------------------|---|--|--|--------------|--------------|-------------|
|  | SC3FCST |                       | Subtotal, kg CO2e/yr                                  |  |  | -4,501,899.4 |              | -4,501,899  |
|  | SC3CC   | Land Application      | Land App Carbon Sequestration, kg CO2e/yr             |  |  | -14,699,522  |              | -14,699,522 |
|  | SC3CCST |                       | Subtotal, kg CO2e/yr                                  |  |  | -14,699,522  |              | -14,699,522 |
|  |         | Scope 1               | CO2 Emissions, mt CO2e/yr                             |  |  | 5,269        |              | 5,269       |
|  |         | Scope 2               | CO2 Emissions, mt CO2e/yr                             |  |  | 0            |              | 0           |
|  |         | Scope 3               | CO2 Emissions, mt CO2e/yr                             |  |  | -18,256      |              | -18,256     |
|  |         | Plant Total           | CO2 Emissions, mt CO2e/yr                             |  |  | -12,988      |              | -12,988     |
|  |         | Plant Total Check     | CO2 Emissions, mt CO2e/yr                             |  |  | -12,988      |              | -12,988     |
| <b>Off-Site Thermal Drying and Pyrolysis</b> |         |                       |   |  |  |              |              |             |
| <b>Hauling and Transportation</b>            |         |                       |   |  |  |              |              |             |
|  |         | Hauling               | Biochar, wet tons/yr                                  |  |  |              | 22,920.1     |             |
|  |         | Hauling               | Large Trucks per year                                 |  |  |              | 1,095.0      |             |
|  |         | Hauling               | Biochar to Customers, Total Miles                     |  |  |              | 219,000.0    |             |
|  |         | Hauling               | Fuel (Diesel) Usage Round Trip, gal/yr                |  |  |              | 39,883.7     |             |
|  | SC3T    | Hauling               | Emissions, kg CO2e/yr                                 |  |  |              | 474,013.5    |             |
|  | SC3TST  |                       | Subtotal, kg CO2e/yr                                  |  |  |              | 474,013.5    |             |
| <b>Electrical Emissions</b>                  |         |                       |   |  |  |              |              |             |
|  |         | Solids Treatment      | Electricity Production, MWh/yr                        |  |  |              | 0.0          |             |
|  |         | Solids Treatment      | Electricity Sold, MWh/yr                              |  |  |              | 0.0          |             |
|  | SC2E    | Solids Treatment      | Emissions Offset, kg CO2e/yr                          |  |  |              | 0.0          |             |
|  |         | Solids Treatment      | Electricity Consumption, MWh/yr                       |  |  |              | 46,456.3     |             |
|  |         | Solids Treatment      | Electricity Purchased, MWh/yr                         |  |  |              | 46,456.3     |             |
|  | SC2E    | Solids Treatment      | Emission, kg CO2e/yr                                  |  |  |              | 0.0          |             |
|  | SC2EST  |                       | Subtotal, kg CO2e/yr                                  |  |  |              | 0.0          |             |
| <b>Natural Gas Emissions</b>                 |         |                       |   |  |  |              |              |             |
|  |         | Solids Treatment      | Thermal Production, MMBtu/yr                          |  |  |              | 415,294      |             |
|  |         | Solids Treatment      | Thermal Consumption, MMBtu/yr                         |  |  |              | -415,295     |             |
|  |         | Solids Treatment      | Thermal Balance, MMBtu/yr                             |  |  |              | 0            |             |
|  |         | Solids Treatment      | External Natural Gas, scf/yr                          |  |  |              | 296,082,227  |             |
|  | SC1NG   | Combustion            | Emission, kg CO2e/yr                                  |  |  |              | 15,692,358   |             |
|  | SC1NGST |                       | Subtotal, kg CO2e/yr                                  |  |  |              | 15,692,358   |             |
|  | SC3NG   | Extraction/Production | Emission, kg CO2e/yr                                  |  |  |              | 4,145,151    |             |
|  | SC3NGST |                       | Subtotal, kg CO2e/yr                                  |  |  |              | 4,145,151    |             |
| <b>Process Fugitive Emissions</b>            |         |                       |   |  |  |              |              |             |
|  | SC1F    | Boiler                | Fugitive Emissions, kg CO2e/yr                        |  |  |              | 7,913.5      |             |
|  | SC1FST  |                       | Subtotal, kg CO2e/yr                                  |  |  |              | 7,913.5      |             |
| <b>Carbon Offsets</b>                        |         |                       |   |  |  |              |              |             |
|  | SC3FC   | Land Application      | Nitrogen and Phosphorus Fertilizer Offset, kg CO2e/yr |  |  |              | -6,028,670.2 |             |
|  | SC3FCST |                       | Subtotal, kg CO2e/yr                                  |  |  |              | -6,028,670.2 |             |
|  | SC3CC   | Land Application      | Land App Carbon Sequestration, kg CO2e/yr             |  |  |              | -19,410,031  |             |
|  | SC3CCST |                       | Subtotal, kg CO2e/yr                                  |  |  |              | -19,410,031  |             |
|  |         | Scope 1               | CO2 Emissions, mt CO2e/yr                             |  |  |              | 15,700       |             |
|  |         | Scope 2               | CO2 Emissions, mt CO2e/yr                             |  |  |              | 0            |             |
|  |         | Scope 3               | CO2 Emissions, mt CO2e/yr                             |  |  |              | -20,820      |             |
|  |         | Plant Total           | CO2 Emissions, mt CO2e/yr                             |  |  |              | -5,119       |             |
|  |         | Plant Total Check     | CO2 Emissions, mt CO2e/yr                             |  |  |              | -5,119       |             |

## **Attachment C: Cost Estimating**

---





| 2034         | 2035         | 2036         | 2037         | 2038         | 2039         | 2040         | 2041         | 2042         | 2043         | 2044         | 2045         | 2046         | 2047         | 2048         | 2049         | 2050         |
|--------------|--------------|--------------|--------------|--------------|--------------|--------------|--------------|--------------|--------------|--------------|--------------|--------------|--------------|--------------|--------------|--------------|
| 4            | 5            | 6            | 7            | 8            | 9            | 10           | 11           | 12           | 13           | 14           | 15           | 16           | 17           | 18           | 19           | 20           |
| 163299       | 166409       | 167619       | 169829       | 171740       | 173880       | 176960       | 178070       | 180180       | 182290       | 184400       | 186510       | 188621       | 190731       | 192841       | 194951       | 197061       |
|              |              |              |              |              |              |              |              |              |              |              |              |              |              |              |              |              |
| \$9,007,485  | \$9,084,131  | \$9,160,777  | \$9,237,422  | \$9,314,068  | \$9,390,713  | \$9,467,359  | \$9,544,004  | \$9,620,650  | \$9,697,296  | \$9,773,941  | \$9,850,587  | \$9,927,232  | \$10,003,878 | \$10,080,524 | \$10,157,169 | \$10,233,815 |
| \$3,592,368  | \$3,622,936  | \$3,653,503  | \$3,684,071  | \$3,714,639  | \$3,745,207  | \$3,775,775  | \$3,806,343  | \$3,836,910  | \$3,867,478  | \$3,898,046  | \$3,928,614  | \$3,959,182  | \$3,989,749  | \$4,020,317  | \$4,050,885  | \$4,081,453  |
| -\$1,372,530 | -\$1,384,209 | -\$1,395,888 | -\$1,407,567 | -\$1,419,246 | -\$1,430,925 | -\$1,442,604 | -\$1,454,283 | -\$1,465,962 | -\$1,477,641 | -\$1,489,320 | -\$1,500,999 | -\$1,512,678 | -\$1,524,357 | -\$1,536,036 | -\$1,547,715 | -\$1,559,394 |
| -\$131,032   | -\$132,147   | -\$133,262   | -\$134,377   | -\$135,492   | -\$136,607   | -\$137,722   | -\$138,837   | -\$139,952   | -\$141,067   | -\$142,182   | -\$143,297   | -\$144,412   | -\$145,527   | -\$146,642   | -\$147,757   | -\$148,872   |
|              |              |              |              |              |              |              |              |              |              |              |              |              |              |              |              |              |
| \$10,717,277 | \$10,850,512 | \$10,983,747 | \$11,116,981 | \$11,250,216 | \$11,383,451 | \$11,516,686 | \$11,649,921 | \$11,783,156 | \$11,916,391 | \$12,049,626 | \$12,182,860 | \$12,316,095 | \$12,449,330 | \$12,582,565 | \$12,715,800 | \$12,849,035 |
| 5,125,547    | 5,189,267    | 5,252,986    | 5,316,706    | 5,380,426    | 5,444,145    | 5,507,865    | 5,571,585    | 5,635,305    | 5,699,024    | 5,762,744    | 5,826,464    | 5,890,183    | 5,953,903    | 6,017,623    | 6,081,342    | 6,145,062    |
| -\$7,030,440 | -\$7,117,841 | -\$7,205,242 | -\$7,292,643 | -\$7,380,044 | -\$7,467,445 | -\$7,554,846 | -\$7,642,247 | -\$7,729,648 | -\$7,817,049 | -\$7,904,450 | -\$7,991,851 | -\$8,079,251 | -\$8,166,652 | -\$8,254,053 | -\$8,341,454 | -\$8,428,855 |
| -\$186,955   | -\$189,280   | -\$191,604   | -\$193,928   | -\$196,252   | -\$198,576   | -\$200,901   | -\$203,225   | -\$205,549   | -\$207,873   | -\$210,197   | -\$212,522   | -\$214,846   | -\$217,170   | -\$219,494   | -\$221,818   | -\$224,142   |
|              |              |              |              |              |              |              |              |              |              |              |              |              |              |              |              |              |
| \$3,224,756  | \$3,302,551  | \$3,380,347  | \$3,458,143  | \$3,535,938  | \$3,613,734  | \$3,691,530  | \$3,769,325  | \$3,847,121  | \$3,924,917  | \$4,002,712  | \$4,080,508  | \$4,158,304  | \$4,236,099  | \$4,313,895  | \$4,391,691  | \$4,469,486  |
| \$1,644,093  | \$1,683,756  | \$1,723,419  | \$1,763,082  | \$1,802,745  | \$1,842,408  | \$1,882,071  | \$1,921,734  | \$1,961,397  | \$2,001,060  | \$2,040,723  | \$2,080,386  | \$2,120,049  | \$2,159,712  | \$2,199,375  | \$2,239,038  | \$2,278,701  |
| -\$59,969    | -\$61,415    | -\$62,862    | -\$64,309    | -\$65,756    | -\$67,202    | -\$68,649    | -\$70,096    | -\$71,542    | -\$72,989    | -\$74,436    | -\$75,883    | -\$77,329    | -\$78,776    | -\$80,223    | -\$81,669    | -\$83,116    |
| \$24,530,599 | \$24,848,259 | \$25,165,920 | \$25,483,581 | \$25,801,242 | \$26,118,903 | \$26,436,563 | \$26,754,224 | \$27,071,885 | \$27,389,546 | \$27,707,207 | \$28,024,868 | \$28,342,528 | \$28,660,189 | \$28,977,850 | \$29,295,511 | \$29,613,172 |
|              |              |              |              |              |              |              |              |              |              |              |              |              |              |              |              |              |
|              |              |              |              |              |              |              |              |              |              |              |              |              |              |              |              |              |
| \$9,053,403  | \$9,130,439  | \$9,207,476  | \$9,284,512  | \$9,361,548  | \$9,438,584  | \$9,515,621  | \$9,592,657  | \$9,669,693  | \$9,746,730  | \$9,823,766  | \$9,900,802  | \$9,977,839  | \$10,054,875 | \$10,131,911 | \$10,208,947 | \$10,285,984 |
| \$0          | \$0          | \$0          | \$0          | \$0          | \$0          | \$0          | \$0          | \$0          | \$0          | \$0          | \$0          | \$0          | \$0          | \$0          | \$0          | \$0          |
| -\$1,458,086 | -\$1,470,493 | -\$1,482,900 | -\$1,495,307 | -\$1,507,714 | -\$1,520,121 | -\$1,532,528 | -\$1,544,935 | -\$1,557,342 | -\$1,569,749 | -\$1,582,156 | -\$1,594,563 | -\$1,606,970 | -\$1,619,377 | -\$1,631,784 | -\$1,644,191 | -\$1,656,598 |
| \$0          | \$0          | \$0          | \$0          | \$0          | \$0          | \$0          | \$0          | \$0          | \$0          | \$0          | \$0          | \$0          | \$0          | \$0          | \$0          | \$0          |
| \$15,040,814 | \$15,227,798 | \$15,414,782 | \$15,601,766 | \$15,788,750 | \$15,975,735 | \$16,162,719 | \$16,349,703 | \$16,536,687 | \$16,723,671 | \$16,910,655 | \$17,097,640 | \$17,284,624 | \$17,471,608 | \$17,658,592 | \$17,845,576 | \$18,032,560 |
| \$3,848,815  | \$3,896,663  | \$3,944,510  | \$3,992,358  | \$4,040,205  | \$4,088,053  | \$4,135,901  | \$4,183,748  | \$4,231,596  | \$4,279,444  | \$4,327,291  | \$4,375,139  | \$4,422,987  | \$4,470,834  | \$4,518,682  | \$4,566,529  | \$4,614,377  |
| -\$7,115,935 | -\$7,204,398 | -\$7,292,862 | -\$7,381,326 | -\$7,469,790 | -\$7,558,254 | -\$7,646,717 | -\$7,735,181 | -\$7,823,645 | -\$7,912,109 | -\$8,000,572 | -\$8,089,036 | -\$8,177,500 | -\$8,265,964 | -\$8,354,427 | -\$8,442,891 | -\$8,531,355 |
| -\$237,683   | -\$240,638   | -\$243,593   | -\$246,548   | -\$249,503   | -\$252,457   | -\$255,412   | -\$258,367   | -\$261,322   | -\$264,277   | -\$267,232   | -\$270,186   | -\$273,141   | -\$276,096   | -\$279,051   | -\$282,006   | -\$284,960   |
| \$3,224,756  | \$3,302,551  | \$3,380,347  | \$3,458,143  | \$3,535,938  | \$3,613,734  | \$3,691,530  | \$3,769,325  | \$3,847,121  | \$3,924,917  | \$4,002,712  | \$4,080,508  | \$4,158,304  | \$4,236,099  | \$4,313,895  | \$4,391,691  | \$4,469,486  |
| \$0          | \$0          | \$0          | \$0          | \$0          | \$0          | \$0          | \$0          | \$0          | \$0          | \$0          | \$0          | \$0          | \$0          | \$0          | \$0          | \$0          |
| \$0          | \$0          | \$0          | \$0          | \$0          | \$0          | \$0          | \$0          | \$0          | \$0          | \$0          | \$0          | \$0          | \$0          | \$0          | \$0          | \$0          |
| \$475,677    | \$487,153    | \$498,628    | \$510,104    | \$521,579    | \$533,055    | \$544,530    | \$556,006    | \$567,481    | \$578,956    | \$590,432    | \$601,907    | \$613,383    | \$624,858    | \$636,334    | \$647,809    | \$659,285    |
| \$4,456,073  | \$4,563,574  | \$4,671,074  | \$4,778,575  | \$4,886,076  | \$4,993,576  | \$5,101,077  | \$5,208,578  | \$5,316,078  | \$5,423,579  | \$5,531,079  | \$5,638,580  | \$5,746,081  | \$5,853,581  | \$5,961,082  | \$6,068,582  | \$6,176,083  |
| -\$634,263   | -\$649,565   | -\$664,866   | -\$680,167   | -\$695,469   | -\$710,770   | -\$726,071   | -\$741,372   | -\$756,674   | -\$771,975   | -\$787,276   | -\$802,578   | -\$817,879   | -\$833,180   | -\$848,482   | -\$863,783   | -\$879,084   |
| -\$603,681   | -\$618,244   | -\$632,808   | -\$647,371   | -\$661,935   | -\$676,498   | -\$691,062   | -\$705,625   | -\$720,188   | -\$734,751   | -\$749,314   | -\$763,877   | -\$778,440   | -\$793,003   | -\$807,566   | -\$822,129   | -\$836,692   |
| -\$496,068   | -\$508,035   | -\$520,003   | -\$531,970   | -\$543,938   | -\$555,906   | -\$567,874   | -\$579,842   | -\$591,810   | -\$603,778   | -\$615,746   | -\$627,714   | -\$639,682   | -\$651,650   | -\$663,618   | -\$675,586   | -\$687,554   |
| \$868,946    | \$876,340    | \$883,734    | \$891,128    | \$898,522    | \$905,916    | \$913,310    | \$920,704    | \$928,098    | \$935,492    | \$942,886    | \$950,279    | \$957,673    | \$965,067    | \$972,461    | \$979,855    | \$987,249    |
| \$527,365    | \$531,853    | \$536,340    | \$540,828    | \$545,315    | \$549,802    | \$554,290    | \$558,777    | \$563,265    | \$567,752    | \$572,239    | \$576,727    | \$581,214    | \$585,702    | \$590,189    | \$594,676    | \$599,164    |
| \$5,716,607  | \$5,765,250  | \$5,813,893  | \$5,862,536  | \$5,911,179  | \$5,959,822  | \$6,008,466  | \$6,057,109  | \$6,105,752  | \$6,154,395  | \$6,203,038  | \$6,251,681  | \$6,300,325  | \$6,348,968  | \$6,397,611  | \$6,446,254  | \$6,494,897  |
| -\$828,910   | -\$835,964   | -\$843,017   | -\$850,070   | -\$857,123   | -\$864,176   | -\$871,229   | -\$878,282   | -\$885,335   | -\$892,388   | -\$899,441   | -\$906,494   | -\$913,547   | -\$920,600   | -\$927,653   | -\$934,706   | -\$941,759   |
| -\$626,656   | -\$631,988   | -\$637,321   | -\$642,653   | -\$647,985   | -\$653,317   | -\$658,649   | -\$663,981   | -\$669,313   | -\$674,645   | -\$679,977   | -\$685,309   | -\$690,641   | -\$695,973   | -\$701,305   | -\$706,637   | -\$711,969   |
| \$31,211,173 | \$31,622,294 | \$32,033,415 | \$32,444,537 | \$32,855,658 | \$33,266,779 | \$33,677,900 | \$34,089,021 | \$34,500,142 | \$34,911,263 | \$35,322,384 | \$35,733,505 | \$36,144,626 | \$36,555,747 | \$36,966,868 | \$37,377,989 | \$37,789,110 |

| Simple SUM     | Present Worth (2020) |
|----------------|----------------------|
| \$198,814,537  | \$122,420,640.57     |
| \$0            | \$0.00               |
| \$79,291,269   | \$48,823,833.90      |
| \$0            | \$0.00               |
| -\$30,294,694  | -\$18,654,047.74     |
| -\$2,892,166   | -\$1,780,859.91      |
| \$244,918,945  | \$150,809,566.82     |
|                |                      |
| \$241,850,408  | \$148,808,792.69     |
| \$0            | \$0.00               |
| \$115,665,169  | \$71,167,934.94      |
| \$0            | \$0.00               |
| -\$158,651,764 | -\$97,617,274.00     |
| -\$4,218,912   | -\$2,595,865.83      |
| \$194,644,900  | \$119,763,587.80     |
|                |                      |
|                |                      |
| \$77,522,124   | \$47,601,147.62      |
| \$0            | \$0.00               |
| \$39,523,491   | \$24,268,730.46      |
| \$0            | \$0.00               |
| -\$1,441,628   | -\$885,207.19        |
| \$115,603,987  | \$70,984,670.89      |
|                |                      |
|                |                      |
| \$199,828,036  | \$123,044,705.59     |
| \$0            | \$0.00               |
| \$0            | \$0.00               |
| \$0            | \$0.00               |
| -\$32,183,084  | -\$19,816,829.34     |
| \$0            | \$0.00               |
| \$167,644,952  | \$103,227,876        |
|                |                      |
|                |                      |
| \$339,417,094  | \$208,840,863.17     |
| \$0            | \$0.00               |
| \$86,853,915   | \$53,440,580.93      |
| \$0            | \$0.00               |
| -\$160,581,063 | -\$98,804,357.29     |
| -\$5,363,656   | -\$3,300,218.63      |
| \$260,326,290  | \$160,176,868        |
|                |                      |
|                |                      |
| \$77,522,124   | \$47,601,148         |
|                |                      |
|                |                      |
| \$11,005,356   | \$7,021,548.40       |
| \$0            | \$0.00               |
| \$103,096,544  | \$65,776,827.67      |
| \$0            | \$0.00               |
| -\$14,674,437  | -\$9,362,466.00      |
| -\$20,340,047  | (12,465,138)         |
| -\$19,655,546  | (11,910,043)         |
| \$59,431,870   | \$39,060,729         |
|                |                      |
|                |                      |
| \$18,340,134   | \$11,809,836.66      |
| \$0            | \$0.00               |
| \$11,130,671   | \$7,167,417.67       |
| \$0            | \$0.00               |
| \$120,655,743  | \$77,694,340.45      |
| \$0            | \$0.00               |
| -\$24,874,060  | (15,361,659)         |
| -\$21,969,634  | (13,408,253)         |
| \$103,282,853  | \$67,901,683         |



|              |              |              |              |              |              |              |              |              |              |              |              |              |              |              |              |              |                |                  |
|--------------|--------------|--------------|--------------|--------------|--------------|--------------|--------------|--------------|--------------|--------------|--------------|--------------|--------------|--------------|--------------|--------------|----------------|------------------|
|              |              |              |              |              |              |              |              |              |              |              |              |              |              |              |              |              |                |                  |
|              |              |              |              |              |              |              |              |              |              |              |              |              |              |              |              |              |                |                  |
|              |              |              |              |              |              |              |              |              |              |              |              |              |              |              |              |              |                |                  |
| \$9,007,485  | \$9,084,131  | \$9,160,777  | \$9,237,422  | \$9,314,068  | \$9,390,713  | \$9,467,359  | \$9,544,004  | \$9,620,650  | \$9,697,296  | \$9,773,941  | \$9,850,587  | \$9,927,232  | \$10,003,878 | \$10,080,524 | \$10,157,169 | \$10,233,815 | \$198,814,537  | \$122,420,640.57 |
| \$0          | \$0          | \$0          | \$0          | \$0          | \$0          | \$0          | \$0          | \$0          | \$0          | \$0          | \$0          | \$0          | \$0          | \$0          | \$0          | \$0          | \$0            | \$0              |
| -\$1,372,530 | -\$1,384,209 | -\$1,395,888 | -\$1,407,567 | -\$1,419,246 | -\$1,430,925 | -\$1,442,604 | -\$1,454,283 | -\$1,465,962 | -\$1,477,641 | -\$1,489,320 | -\$1,500,999 | -\$1,512,678 | -\$1,524,357 | -\$1,536,036 | -\$1,547,715 | -\$1,559,394 | -\$30,294,694  | -\$18,654,047.74 |
| \$0          | \$0          | \$0          | \$0          | \$0          | \$0          | \$0          | \$0          | \$0          | \$0          | \$0          | \$0          | \$0          | \$0          | \$0          | \$0          | \$0          | \$0            | \$0              |
|              |              |              |              |              |              |              |              |              |              |              |              |              |              |              |              |              |                |                  |
|              |              |              |              |              |              |              |              |              |              |              |              |              |              |              |              |              |                |                  |
|              |              |              |              |              |              |              |              |              |              |              |              |              |              |              |              |              |                |                  |
| \$10,717,277 | \$10,850,512 | \$10,983,747 | \$11,116,981 | \$11,250,216 | \$11,383,451 | \$11,516,686 | \$11,649,921 | \$11,783,156 | \$11,916,391 | \$12,049,626 | \$12,182,860 | \$12,316,095 | \$12,449,330 | \$12,582,565 | \$12,715,800 | \$12,849,035 | \$241,850,408  | \$148,808,792.69 |
| \$0          | \$0          | \$0          | \$0          | \$0          | \$0          | \$0          | \$0          | \$0          | \$0          | \$0          | \$0          | \$0          | \$0          | \$0          | \$0          | \$0          | \$0            | \$0              |
| -\$7,030,440 | -\$7,117,841 | -\$7,205,242 | -\$7,292,643 | -\$7,380,044 | -\$7,467,445 | -\$7,554,846 | -\$7,642,247 | -\$7,729,648 | -\$7,817,049 | -\$7,904,450 | -\$7,991,851 | -\$8,079,251 | -\$8,166,652 | -\$8,254,053 | -\$8,341,454 | -\$8,428,855 | -\$158,651,764 | -\$97,617,274.00 |
| \$0          | \$0          | \$0          | \$0          | \$0          | \$0          | \$0          | \$0          | \$0          | \$0          | \$0          | \$0          | \$0          | \$0          | \$0          | \$0          | \$0          | \$0            | \$0              |
|              |              |              |              |              |              |              |              |              |              |              |              |              |              |              |              |              |                |                  |
|              |              |              |              |              |              |              |              |              |              |              |              |              |              |              |              |              |                |                  |
|              |              |              |              |              |              |              |              |              |              |              |              |              |              |              |              |              |                |                  |
| \$3,224,756  | \$3,302,551  | \$3,380,347  | \$3,458,143  | \$3,535,938  | \$3,613,734  | \$3,691,530  | \$3,769,325  | \$3,847,121  | \$3,924,917  | \$4,002,712  | \$4,080,508  | \$4,158,304  | \$4,236,099  | \$4,313,895  | \$4,391,691  | \$4,469,486  | \$77,522,124   | \$47,601,147.62  |
| \$0          | \$0          | \$0          | \$0          | \$0          | \$0          | \$0          | \$0          | \$0          | \$0          | \$0          | \$0          | \$0          | \$0          | \$0          | \$0          | \$0          | \$0            | \$0              |
| \$0          | \$0          | \$0          | \$0          | \$0          | \$0          | \$0          | \$0          | \$0          | \$0          | \$0          | \$0          | \$0          | \$0          | \$0          | \$0          | \$0          | \$0            | \$0              |
|              |              |              |              |              |              |              |              |              |              |              |              |              |              |              |              |              |                |                  |
|              |              |              |              |              |              |              |              |              |              |              |              |              |              |              |              |              |                |                  |
| \$1,179,061  | \$1,194,297  | \$1,209,533  | \$1,224,768  | \$1,240,004  | \$1,255,239  | \$1,270,475  | \$1,285,711  | \$1,300,946  | \$1,316,182  | \$1,331,417  | \$1,346,653  | \$1,361,888  | \$1,377,124  | \$1,392,360  | \$1,407,595  | \$1,422,831  | \$25,561,855   | \$16,414,497.08  |
| \$8,298,007  | \$8,405,232  | \$8,512,457  | \$8,619,682  | \$8,726,907  | \$8,834,132  | \$8,941,358  | \$9,048,583  | \$9,155,808  | \$9,263,033  | \$9,370,258  | \$9,477,483  | \$9,584,708  | \$9,691,933  | \$9,799,158  | \$9,906,383  | \$10,013,608 | \$179,899,401  | \$115,522,063.86 |
| -\$189,933   | -\$192,387   | -\$194,841   | -\$197,295   | -\$199,750   | -\$404,408   | -\$409,316   | -\$414,225   | -\$419,133   | -\$424,042   | -\$428,950   | -\$542,324   | -\$548,459   | -\$554,595   | -\$560,731   | -\$566,866   | -\$573,002   | -\$7,283,432   | (4,468,103)      |
| \$23,833,683 | \$24,142,285 | \$24,450,888 | \$24,759,491 | \$25,068,093 | \$25,376,695 | \$25,685,297 | \$25,993,899 | \$26,302,501 | \$26,611,103 | \$26,919,705 | \$27,228,307 | \$27,536,909 | \$27,845,511 | \$28,154,113 | \$28,462,715 | \$28,771,317 | \$198,177,824  | \$127,468,458    |

|              |              |              |              |              |              |              |              |              |              |              |              |              |              |              |              |              |                |                   |
|--------------|--------------|--------------|--------------|--------------|--------------|--------------|--------------|--------------|--------------|--------------|--------------|--------------|--------------|--------------|--------------|--------------|----------------|-------------------|
|              |              |              |              |              |              |              |              |              |              |              |              |              |              |              |              |              |                |                   |
|              |              |              |              |              |              |              |              |              |              |              |              |              |              |              |              |              |                |                   |
|              |              |              |              |              |              |              |              |              |              |              |              |              |              |              |              |              |                |                   |
| \$9,053,403  | \$9,130,439  | \$9,207,476  | \$9,284,512  | \$9,361,548  | \$9,438,584  | \$9,515,621  | \$9,592,657  | \$9,669,693  | \$9,746,730  | \$9,823,766  | \$9,900,802  | \$9,977,839  | \$10,054,875 | \$10,131,911 | \$10,208,947 | \$10,285,984 | \$199,828,036  | \$123,044,705.59  |
| \$0          | \$0          | \$0          | \$0          | \$0          | \$0          | \$0          | \$0          | \$0          | \$0          | \$0          | \$0          | \$0          | \$0          | \$0          | \$0          | \$0          | \$0            | \$0               |
| -\$1,458,086 | -\$1,470,493 | -\$1,482,900 | -\$1,495,307 | -\$1,507,714 | -\$1,520,121 | -\$1,532,528 | -\$1,544,935 | -\$1,557,342 | -\$1,569,749 | -\$1,582,156 | -\$1,594,563 | -\$1,606,970 | -\$1,619,377 | -\$1,631,784 | -\$1,644,191 | -\$1,656,598 | -\$32,183,084  | -\$19,816,829.34  |
| \$0          | \$0          | \$0          | \$0          | \$0          | \$0          | \$0          | \$0          | \$0          | \$0          | \$0          | \$0          | \$0          | \$0          | \$0          | \$0          | \$0          | \$0            | \$0               |
|              |              |              |              |              |              |              |              |              |              |              |              |              |              |              |              |              |                |                   |
|              |              |              |              |              |              |              |              |              |              |              |              |              |              |              |              |              |                |                   |
|              |              |              |              |              |              |              |              |              |              |              |              |              |              |              |              |              |                |                   |
| \$10,841,472 | \$10,976,251 | \$11,111,030 | \$11,245,809 | \$11,380,587 | \$11,515,366 | \$11,650,145 | \$11,784,924 | \$11,919,703 | \$12,054,482 | \$12,189,260 | \$12,324,039 | \$12,458,818 | \$12,593,597 | \$12,728,376 | \$12,863,155 | \$12,997,934 | \$234,350,690  | \$150,533,236.19  |
| \$4,955,982  | \$5,017,594  | \$5,079,206  | \$5,140,817  | \$5,202,429  | \$5,264,041  | \$5,325,652  | \$5,387,264  | \$5,448,876  | \$5,510,488  | \$5,572,099  | \$5,633,711  | \$5,695,323  | \$5,756,934  | \$5,818,546  | \$5,880,158  | \$5,941,769  | \$107,129,166  | \$68,813,537.58   |
| -\$7,495,389 | -\$7,588,570 | -\$7,681,751 | -\$7,774,932 | -\$7,868,113 | -\$7,961,294 | -\$8,054,475 | -\$8,147,656 | -\$8,240,837 | -\$8,334,018 | -\$8,427,199 | -\$8,520,380 | -\$8,613,561 | -\$8,706,742 | -\$8,799,924 | -\$8,893,105 | -\$8,986,286 | -\$162,021,312 | -\$104,073,055.74 |
| -\$306,056   | -\$309,861   | -\$313,666   | -\$317,471   | -\$321,276   | -\$325,080   | -\$328,885   | -\$332,690   | -\$336,495   | -\$340,300   | -\$344,105   | -\$347,909   | -\$351,714   | -\$355,519   | -\$359,324   | -\$363,129   | -\$366,933   | -\$6,615,753   | -\$4,249,574.29   |
|              |              |              |              |              |              |              |              |              |              |              |              |              |              |              |              |              |                |                   |
|              |              |              |              |              |              |              |              |              |              |              |              |              |              |              |              |              |                |                   |
|              |              |              |              |              |              |              |              |              |              |              |              |              |              |              |              |              |                |                   |
| \$3,224,756  | \$3,302,551  | \$3,380,347  | \$3,458,143  | \$3,535,938  | \$3,613,734  | \$3,691,530  | \$3,769,325  | \$3,847,121  | \$3,924,917  | \$4,002,712  | \$4,080,508  | \$4,158,304  | \$4,236,099  | \$4,313,895  | \$4,391,691  | \$4,469,486  | \$77,522,124   | \$47,601,147.62   |
| \$0          | \$0          | \$0          | \$0          | \$0          | \$0          | \$0          | \$0          | \$0          | \$0          | \$0          | \$0          | \$0          | \$0          | \$0          | \$0          | \$0          | \$0            | \$0               |
| \$0          | \$0          | \$0          | \$0          | \$0          | \$0          | \$0          | \$0          | \$0          | \$0          | \$0          | \$0          | \$0          | \$0          | \$0          | \$0          | \$0          | \$0            | \$0               |
|              |              |              |              |              |              |              |              |              |              |              |              |              |              |              |              |              |                |                   |
|              |              |              |              |              |              |              |              |              |              |              |              |              |              |              |              |              |                |                   |
|              |              |              |              |              |              |              |              |              |              |              |              |              |              |              |              |              |                |                   |
| \$475,677    | \$487,153    | \$498,628    | \$510,104    | \$521,579    | \$533,055    | \$544,530    | \$556,006    | \$567,481    | \$578,956    | \$590,432    | \$601,907    | \$613,383    | \$624,858    | \$636,334    | \$647,809    | \$659,285    | \$11,005,356   | \$7,021,548.40    |
| \$4,456,073  | \$4,563,574  | \$4,671,074  | \$4,778,575  | \$4,886,076  | \$4,993,576  | \$5,101,077  | \$5,208,578  | \$5,316,078  | \$5,423,579  | \$5,531,079  | \$5,638,580  | \$5,746,081  | \$5,853,581  | \$5,961,082  | \$6,068,582  | \$6,176,083  | \$103,096,544  | \$65,776,827.67   |
| -\$634,263   | -\$649,565   | -\$664,866   | -\$680,167   | -\$695,469   | -\$710,770   | -\$726,071   | -\$741,372   | -\$756,674   | -\$771,975   | -\$787,276   | -\$802,578   | -\$817,879   | -\$833,180   | -\$848,482   | -\$863,783   | -\$879,084   | -\$14,674,437  | -\$9,362,466.00   |
| -\$603,681   | -\$618,244   | -\$632,808   | -\$647,371   | -\$661,935   | -\$676,498   | -\$691,062   | -\$705,625   | -\$720,188   | -\$734,751   | -\$749,314   | -\$763,877   | -\$778,440   | -\$793,003   | -\$807,566   | -\$822,129   | -\$836,692   | -\$20,340,047  | -\$12,465,137.79  |
| -\$496,068   | -\$508,035   | -\$520,003   | -\$531,970   | -\$543,938   | -\$555,906   | -\$567,874   | -\$579,842   | -\$591,810   | -\$603,778   | -\$615,746   | -\$627,714   | -\$639,682   | -\$651,650   | -\$663,618   | -\$675,586   | -\$687,554   | -\$19,655,546  | -\$11,910,043.36  |
|              |              |              |              |              |              |              |              |              |              |              |              |              |              |              |              |              |                |                   |
|              |              |              |              |              |              |              |              |              |              |              |              |              |              |              |              |              |                |                   |
|              |              |              |              |              |              |              |              |              |              |              |              |              |              |              |              |              |                |                   |
| \$868,946    | \$876,340    | \$883,734    | \$891,128    | \$898,522    | \$905,916    | \$913,310    | \$920,704    | \$928,098    | \$935,492    | \$942,886    | \$950,279    | \$957,673    | \$965,067    | \$972,461    | \$979,855    | \$987,249    | \$18,340,134   | \$11,809,836.66   |
| \$527,365    | \$531,853    | \$536,340    | \$540,828    | \$545,315    | \$549,802    | \$554,290    | \$558,777    | \$563,265    | \$567,752    | \$572,239    | \$576,727    | \$581,214    | \$585,702    | \$590,189    | \$594,676    | \$599,164    | \$11,130,671   | \$7,167,417.67    |
| \$5,716,607  | \$5,765,250  | \$5,813,893  | \$5,862,536  | \$5,911,179  | \$5,959,822  | \$6,008,466  | \$6,057,109  | \$6,105,752  | \$6,154,395  | \$6,203,038  | \$6,251,681  | \$6,300,325  | \$6,348,968  | \$6,397,611  | \$6,446,254  | \$6,494,897  | \$120,655,743  | \$77,694,340.45   |
| -\$828,910   | -\$835,964   | -\$843,017   | -\$850,070   | -\$857,123   | -\$1,296,265 | -\$1,306,845 | -\$1,317,425 | -\$1,328,005 | -\$1,338,585 | -\$1,349,165 | -\$1,812,993 | -\$1,827,099 | -\$1,841,206 | -\$1,855,312 | -\$1,869,419 | -\$1,883,525 | -\$24,874,060  | (15,361,659)      |
| -\$626,656   | -\$631,988   | -\$637,321   | -\$642,653   | -\$647,985   | -\$1,119,973 | -\$1,129,114 | -\$1,138,255 | -\$1,147,396 | -\$1,156,537 | -\$1,165,678 | -\$1,762,229 | -\$1,775,940 | -\$1,789,652 | -\$1,803,364 | -\$1,817,075 | -\$1,830,787 | -\$21,969,634  | (13,408,253)      |
| \$27,671,172 | \$28,038,284 | \$28,405,397 | \$28,772,509 | \$29,139,622 | \$27,872,667 | \$28,216,614 | \$28,560,561 | \$28,904,508 | \$29,248,455 | \$29,592,402 | \$27,975,716 | \$28,294,026 | \$28,612,337 | \$28,930,647 | \$29,248,958 | \$29,567,268 | \$103,282,853  | \$67,901,683      |

| Performance Summary                     |                                  |                                      | 1   | 2   | 3                     | 4  |
|---|----------------------------------|--------------------------------------|---|---|-----------------------|--|
| O&M Costs Based on 2050 Flows and Loads |                                  |                                      | 100% Class B application with MAD at all three plants | TAD-Batch , Cambi, and Off-site Soil Blending or Composting | Off-site Pyrolysis    | TAD-Batch and Off-site Soil Blending or Composting |
| Element                                 |                                  | Notes                                | \$1   | \$2   | \$3                   | \$4  |
| <b>West Point Treatment plant</b>       |                                  |                                      |   |   |                       |  |
|   | <b>Operation and Maintenance</b> |                                      |   |   |                       |  |
|   | Solids Treatment                 | Operation and Maintenance, \$/yr     | \$8,220,708   | \$7,669,298   | \$8,220,708           | \$7,669,298  |
|   | TAD-Batch                        | Operation and Maintenance, \$/yr     | \$0   | \$365,490   | \$0                   | \$365,490  |
|   | <b>Process Fuel Consumption</b>  |                                      |   |   |                       |  |
|   | Solids Treatment                 | Natural Gas Consumption, \$/yr       | \$0   | \$0   | \$0                   | \$0  |
|   | <b>Electricity Consumption</b>   |                                      |   |   |                       |  |
|   | Solids Treatment                 | Electricity Consumption, \$/yr       | \$821,834   | \$917,555   | \$821,834             | \$917,555  |
|   | <b>Electricity Sales</b>         |                                      |   |   |                       |  |
|   | CHP                              | Electricity Sales Revenue, \$/yr     | \$1,559,394   | \$1,656,598   | \$1,559,394           | \$1,656,598  |
|   | <b>Chemical Usage</b>            |                                      |   |   |                       |  |
|   | Dewatering                       | Polymer Use, \$/yr                   | \$1,191,274   | \$1,111,368   | \$1,191,274           | \$1,111,368  |
|   | Dewatering (TAD)                 | Polymer Use, \$/yr                   | \$0   | \$222,274   | \$0                   | \$222,274  |
|   | <b>Land Application</b>          |                                      |   |   |                       |  |
|   | Agriculture                      | Land App Eastern WA Cost, \$/yr      | \$3,624,176   | To Off-site Soil Blending                                   | To Off-site Pyrolysis | To Off-site Soil Blending                          |
|   | Forestry                         | Land App Western WA Cost, \$/yr      | \$457,277   |   |                       |  |
|   | Agriculture                      | Land App Eastern WA Revenue, \$/yr   | \$99,997  |   |                       |  |
|   | Forestry                         | Land App Western WA, Revenue, \$/yr  | \$48,875  |   |                       |  |
| <b>South Treatment Plant</b>            |                                  |                                      |   |   |                       |  |
|   | <b>Operation and Maintenance</b> |                                      |   |   |                       |  |
|   | Solids Treatment                 | Operation and Maintenance, \$/yr     | \$9,717,031   | \$9,717,031   | \$9,717,031           | \$9,717,031  |
|   | THP-MAD                          | Operation and Maintenance, \$/yr     | \$0   | \$2,479,298   | \$0                   |  |
|   | <b>Process Fuel Consumption</b>  |                                      |   |   |                       |  |
|   | Solids Treatment                 | Natural Gas Consumption, \$/yr       | \$515,568   | \$924,448   | \$515,568             | \$746,378  |
|   | <b>Potable Water Usage</b>       |                                      |   |   |                       |  |
|   | THP                              | Potable Water, \$/yr                 | \$0   | \$456,495   | \$0                   | 0.0  |
|   | <b>Biogas Upgrading Sales</b>    |                                      |   |   |                       |  |
|   | Biogas                           | Renewable Natural gas Value, \$/yr   | \$994,558   | \$1,006,652   | \$994,558             | \$1,060,332  |
|   | Biogas                           | Renewable Natural Gas RINs, \$/yr    | \$5,964,479   | \$6,037,011   | \$5,964,479           | \$6,358,932  |
|   | Biogas                           | Renewable Natural Gas CA LCFS, \$/yr | \$1,469,818   | \$1,487,692   | \$1,469,818           | \$1,567,022  |
|   | <b>Electricity Consumption</b>   |                                      |   |   |                       |  |
|   | Solids Treatment                 | Electricity Consumption, \$/yr       | \$984,123   | \$1,467,406   | \$984,123             | \$1,017,100  |
|   | <b>Chemical Usage</b>            |                                      |   |   |                       |  |
|   | Predewatering                    | Polymer Use, \$/yr                   | \$0   | \$1,444,086   | \$0                   | \$0  |



|   |                  |                                     |  |             |                        |                       |                        |
|---|------------------|-------------------------------------|--|-------------|------------------------|-----------------------|------------------------|
|   | Dewatering       | Polymer Use, \$/yr                  |  | \$1,632,313 | \$1,543,797            | \$1,632,313           | \$1,517,425            |
| <b>Land Application</b>                         |                  |                                     |  |             |                        |                       |                        |
|   | Agriculture      | Land App Eastern WA Cost, \$/yr     |  | \$5,456,583 | \$2,626,216            | To Off-site Pyrolysis | \$3,381,685            |
|   | Forestry         | Land App Western WA Cost, \$/yr     |  | \$688,479   | \$1,988,161            |                       | \$2,560,085            |
|   | Agriculture      | Land App Eastern WA Revenue, \$/yr  |  | \$150,556   | \$72,462               |                       | \$93,306               |
|   | Forestry         | Land App Western WA, Revenue, \$/yr |  | \$73,586    | \$212,499              |                       | \$273,627              |
| <b>Brightwater Treatment Plant</b>              |                  |                                     |  |             |                        |                       |                        |
| <b>Operation and Maintenance</b>                |                  |                                     |  |             |                        |                       |                        |
|   | Solids Treatment | Operation and Maintenance, \$/yr    |  | \$3,649,507 | \$3,649,507            | \$3,649,507           | \$3,649,507            |
| <b>Process Fuel Consumption</b>                 |                  |                                     |  |             |                        |                       |                        |
|   | Solids Treatment | Natural Gas Consumption, \$/yr      |  | \$0         | \$0                    | \$0                   | \$0                    |
| <b>Electricity Consumption</b>                  |                  |                                     |  |             |                        |                       |                        |
|   | Solids Treatment | Electricity Consumption, \$/yr      |  | \$277,341   | \$277,341              | \$277,341             | \$277,341              |
| <b>Chemical Usage</b>                           |                  |                                     |  |             |                        |                       |                        |
|   | Dewatering       | Polymer Use, \$/yr                  |  | \$542,639   | \$542,639              | \$542,639             | \$542,639              |
| <b>Land Application</b>                         |                  |                                     |  |             |                        |                       |                        |
|   | Agriculture      | Land App Eastern WA Cost, \$/yr     |  | \$2,023,400 | To Off-site Composting | To Off-site Pyrolysis | To Off-site Composting |
|   | Forestry         | Land App Western WA Cost, \$/yr     |  | \$255,301   |                        |                       |                        |
|   | Agriculture      | Land App Eastern WA Revenue, \$/yr  |  | \$55,829    |                        |                       |                        |
|   | Forestry         | Land App Western WA, Revenue, \$/yr |  | \$27,287    |                        |                       |                        |
| <b>Off-Site Composting (Brightwater Solids)</b> |                  |                                     |  |             |                        |                       |                        |
| <b>Hauling and Transportation</b>               |                  |                                     |  |             |                        |                       |                        |
|   | Biosolids        | Hauling Cost, \$/yr                 |  |             | \$238,448              |                       | \$238,448              |
|   | Biosolids        | Fuel Cost (Diesel), \$/yr           |  |             | \$28,716               |                       | \$28,716               |
|   | Woodchips        | Hauling Cost, \$/yr                 |  |             | \$310,317              |                       | \$310,317              |
|   | Woodchips        | Fuel Cost (Diesel), \$/yr           |  |             | \$81,804               |                       | \$81,804               |
| <b>Operation and Maintenance</b>                |                  |                                     |  |             |                        |                       |                        |
|   | Composting       | Operation and Maintenance, \$/yr    |  |             | \$5,592,946            |                       | \$5,592,946            |
|   | Composting       | Equipment Upgrades, \$/yr           |  |             | \$80,000               |                       | \$80,000               |
| <b>Electricity Consumption</b>                  |                  |                                     |  |             |                        |                       |                        |
|   | Composting       | Electricity Costs, \$/yr            |  |             | \$143,101              |                       | \$143,101              |
| <b>Process Fuel Consumption</b>                 |                  |                                     |  |             |                        |                       |                        |
|   | Composting       | Fuel Consumption (Diesel), \$/yr    |  |             | \$360,036              |                       | \$360,036              |
| <b>Revenues</b>                                 |                  |                                     |  |             |                        |                       |                        |
|   | Woodchips        | Tipping Fee, \$/yr                  |  |             | \$879,084              |                       | \$879,084              |
|   | Compost          | Revenue Year 1-2 (Commercial)       |  |             | \$418,348              |                       | \$418,348              |
|   | Compost          | Revenue Year 3-8 (Commercial)       |  |             | \$836,697              |                       | \$836,697              |
|   | Compost          | Revenue Year 9-14 (Commercial)      |  |             | \$1,255,045            |                       | \$1,255,045            |
|   | Compost          | Revenue Year 15-20 (Commercial)     |  |             | \$1,673,394            |                       | \$1,673,394            |
|   | Compost          | Revenue Year 1-2 (Consumer)         |  |             | \$294,663              |                       | \$294,663              |
|   | Compost          | Revenue Year 3-8 (Consumer)         |  |             | \$687,547              |                       | \$687,547              |

|   |                    |                                    |  |  |             |             |             |
|---|--------------------|------------------------------------|--|--|-------------|-------------|-------------|
|   | Compost            | Revenue Year 9-14 (Consumer)       |  |  | \$1,178,651 |             | \$1,178,651 |
|   | Compost            | Revenue Year 15-20 (Consumer)      |  |  | \$1,767,977 |             | \$1,767,977 |
| <b>Off-Site Soil Blending (West Point Solids)</b> |                    |                                    |  |  |             |             |             |
| <b>Hauling and Transport</b>                      |                    |                                    |  |  |             |             |             |
|   | Biosolids          | Hauling Cost, \$/yr                |  |  | \$398,444   |             | \$398,444   |
|   | Biosolids          | Fuel Cost (Diesel), \$/yr          |  |  | \$43,074    |             | \$43,074    |
|   | Woodchips          | Hauling Cost, \$/yr                |  |  | \$98,702    |             | \$98,702    |
|   | Woodchips          | Fuel Cost (Diesel), \$/yr          |  |  | \$47,308    |             | \$47,308    |
|   | Fine Sand          | Hauling Cost, \$/yr                |  |  | \$322,740   |             | \$322,740   |
|   | Fine Sand          | Fuel Cost (Diesel), \$/yr          |  |  | \$76,981    |             | \$76,981    |
| <b>Feedstock Purchase</b>                         |                    |                                    |  |  |             |             |             |
|   | Fine Sand          | Feedstock Purchase, \$/yr          |  |  | \$399,443   |             | \$399,443   |
|   | Saw Dust           | Feedstock Purchase, \$/yr          |  |  | \$199,721   |             | \$199,721   |
| <b>Operation and Maintenance</b>                  |                    |                                    |  |  |             |             |             |
|   | Soil Blending      | Operation and Maintenance, \$/yr   |  |  | \$6,147,421 |             | \$6,147,421 |
|   | Soil Blending      | Equipment Upgrades, \$/yr          |  |  | \$40,000    |             | \$40,000    |
| <b>Electricity Consumption</b>                    |                    |                                    |  |  |             |             |             |
|   | Soil Blending      | Electricity Costs, MWh/yr          |  |  | \$0         |             | \$0         |
| <b>Process Fuel Consumption</b>                   |                    |                                    |  |  |             |             |             |
|   | Soil Blending      | Fuel Consumption (Diesel), \$/yr   |  |  | \$307,476   |             | \$307,476   |
| <b>Revenues</b>                                   |                    |                                    |  |  |             |             |             |
|   | Soil Blend         | Revenue Year 1-2 (Commercial)      |  |  | \$470,881   |             | \$470,881   |
|   | Soil Blend         | Revenue Year 3-8 (Commercial)      |  |  | \$941,763   |             | \$941,763   |
|   | Soil Blend         | Revenue Year 9-14 (Commercial)     |  |  | \$1,412,644 |             | \$1,412,644 |
|   | Soil Blend         | Revenue Year 15-20 (Commercial)    |  |  | \$1,883,525 |             | \$1,883,525 |
|   | Soil Blend         | Revenue Year 1-2 (Consumer)        |  |  | \$305,131   |             | \$305,131   |
|   | Soil Blend         | Revenue Year 3-8 (Consumer)        |  |  | \$711,973   |             | \$711,973   |
|   | Soil Blend         | Revenue Year 9-14 (Consumer)       |  |  | \$1,220,524 |             | \$1,220,524 |
|   | Soil Blend         | Revenue Year 15-20 (Consumer)      |  |  | \$1,830,787 |             | \$1,830,787 |
| <b>Off-Site Thermal Drying and Pyrolysis</b>      |                    |                                    |  |  |             |             |             |
| <b>Hauling and Transport</b>                      |                    |                                    |  |  |             |             |             |
|   | Biosolids          | Hauling Cost, \$/yr                |  |  |             | \$1,286,429 |             |
|   | Biosolids          | Fuel Cost (Diesel), \$/yr          |  |  |             | \$136,402   |             |
| <b>Operation and Maintenance</b>                  |                    |                                    |  |  |             |             |             |
|   | Drying + Pyrolysis | Operation and Maintenance, \$/yr   |  |  |             | \$2,990,705 |             |
|   | Drying + Pyrolysis | Spare parts and replacement, \$/yr |  |  |             | \$1,500,000 |             |
| <b>Electricity Consumption</b>                    |                    |                                    |  |  |             |             |             |
|   | Drying + Pyrolysis | Electricity Costs, \$/yr           |  |  |             | \$3,521,388 |             |
| <b>Process Fuel Consumption</b>                   |                    |                                    |  |  |             |             |             |
|   | Drying + Pyrolysis | Natural Gas Consumption, \$/yr     |  |  |             | \$2,001,516 |             |
| <b>Revenues</b>                                   |                    |                                    |  |  |             |             |             |
|   | Biochar            | Revenue Year 1-2 (Contract P3)     |  |  |             | \$171,901   |             |
|   | Biochar            | Revenue Year 3-8 (Contract P3)     |  |  |             | \$229,201   |             |

|  |         |                                  |  |  |  |           |  |
|--|---------|----------------------------------|--|--|--|-----------|--|
|  | Biochar | Revenue Year 9-14 (Contract P3)  |  |  |  | \$458,402 |  |
|  | Biochar | Revenue Year 15-20 (Contract P3) |  |  |  | \$573,002 |  |
|  |         |                                  |  |  |  |           |  |

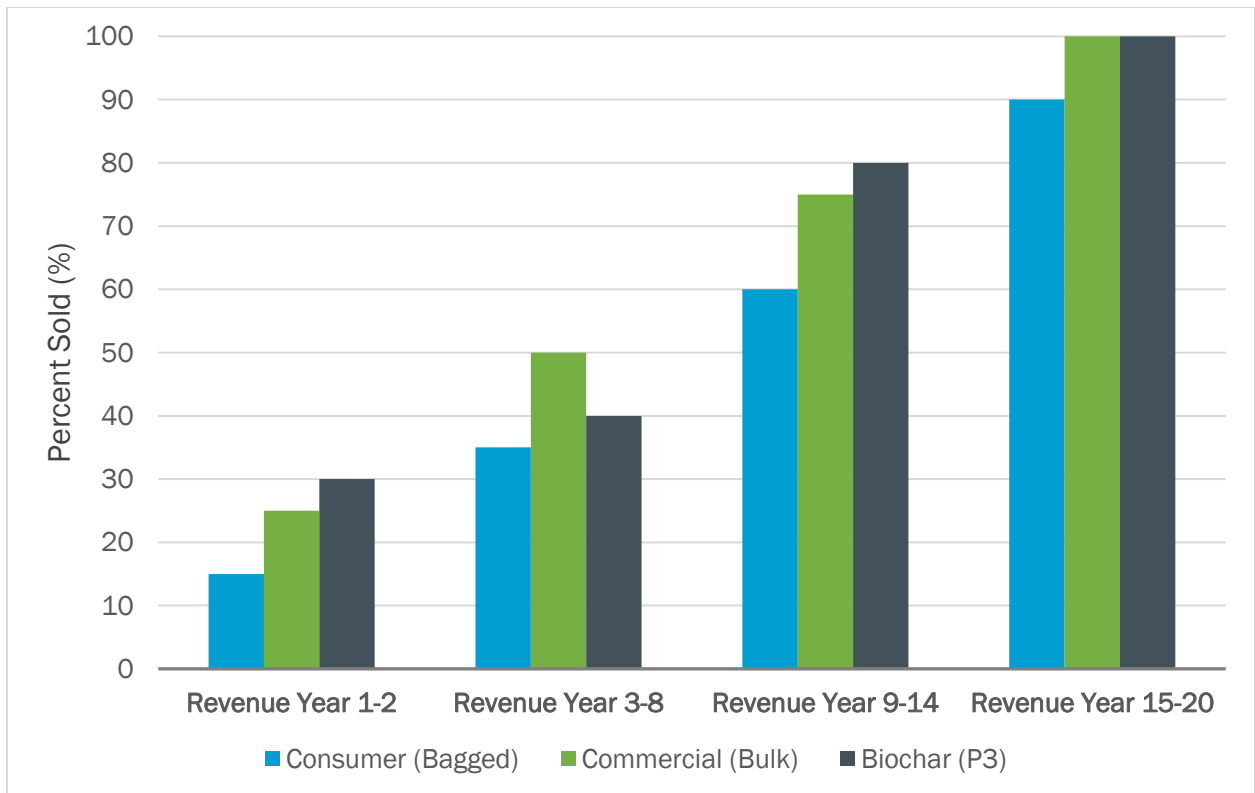
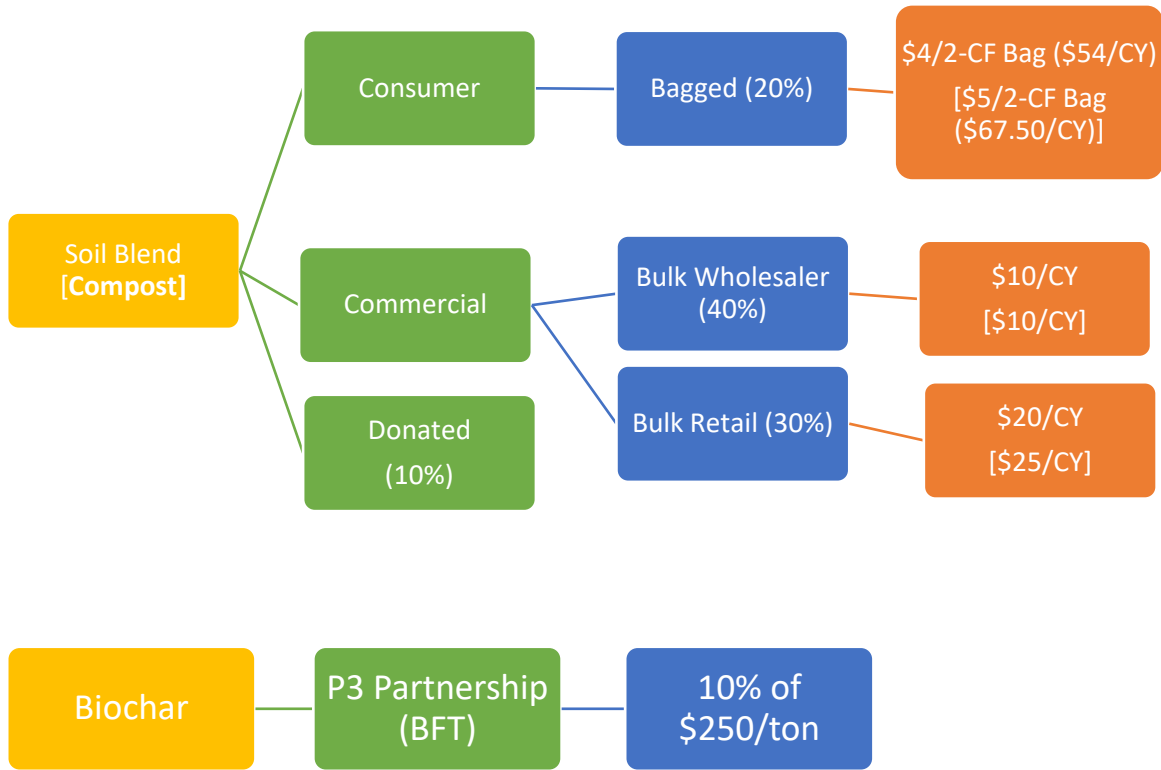

| Estimate - AACEI Class 5                              |   |                 |              |                   |                           |
|---|---|-----------------|--------------|-------------------|---------------------------|
| <b>Project Name:</b>                                  | KC Class A Biosolids Tech Evaluation                      |                 |              | <b>Date:</b>      | 1/2/2020                  |
| <b>Location:</b>                                      | West Point  |                 |              | <b>Estimator:</b> | Steve Krugel and Trung Le |
| <b>Description:</b>                                   | <b>MAD upgrades</b>                                       |                 |              | <b>Version:</b>   | Revision 01               |
| <b>DIRECT: SUBTOTAL CONSTRUCTION COSTS</b>            |   |                 |              |                   |                           |
| <b>Item No.</b>                                       | <b>Item Description</b>                                   | <b>Quantity</b> | <b>Units</b> | <b>Unit Cost</b>  | <b>Item Cost</b>          |
| 1   | MAD Digester - West Point (2 Additional 2.4 MG Digesters) | 4.80            | \$/MG        | 8000000           | \$ 38,400,000             |
| 4   |   |                 |              |                   | \$ -                      |
| <b>Construction Cost Markup</b>                       |   |                 |              |                   | \$ 11,712,000             |
| <b>Subtotal Construction Costs</b>                    |   |                 |              |                   | \$ 50,112,000             |
| Allowance for Indeterminates (Design Allowance)       |   |                 |              |                   | \$ 12,528,000             |
| Street Use Permit                                     |   |                 |              |                   | \$ -                      |
| <b>ESTIMATED PROBABLE COST OF CONSTRUCTION BID</b>    |   |                 |              |                   | \$ 62,640,000             |
| <b>DIRECT: SUBTOTAL ADDITIONAL CONSTRUCTION COSTS</b> |   |                 |              |                   |                           |
| Mitigation Construction Contracts                     |   |                 |              |                   | \$ -                      |
| Construction Change Order Allowance                   |   |                 |              |                   | \$ 6,264,000              |
| Material Pricing Uncertainty Allowance                |   |                 |              |                   | \$ -                      |
| <b>Subtotal Primary Construction Amount</b>           |   |                 |              |                   | \$ 68,904,000             |
| Construction Sales Tax                                |   |                 |              |                   | \$ 6,959,304              |
| Owner Furnished Equipment                             |   |                 |              |                   | \$ -                      |
| Outside Agency Construction                           |   |                 |              |                   | \$ -                      |
| <b>Subtotal KC Contribution to Construction</b>       |   |                 |              |                   | \$ 75,863,304             |
| <b>DIRECT: SUBTOTAL OTHER CAPITAL CHARGES</b>         |   |                 |              |                   |                           |
| KC/WTD Direct Implementation                          |   |                 |              |                   | \$ -                      |
| Misc. Capital Costs                                   |   |                 |              |                   | \$ 137,808                |
| <b>TOTAL DIRECT CONSTRUCTION COSTS</b>                |   |                 |              |                   | \$ 76,001,000             |
| <b>INDIRECT: NON-CONSTRUCTION COSTS</b>               |   |                 |              |                   |                           |
| Design and Construction Consulting                    |   |                 |              |                   | \$ 22,442,520             |
| Other Consulting Services                             |   |                 |              |                   | \$ -                      |
| Permitting & Other Agency Support                     |   |                 |              |                   | \$ 689,040                |
| Right-of-Way  |   |                 |              |                   | \$ -                      |
| Misc. Service & Materials                             |   |                 |              |                   | \$ 551,232                |
| Non-WTD Support                                       |   |                 |              |                   | \$ 585,684                |
| WTD Staff Labor                                       |   |                 |              |                   | \$ 7,923,941              |
| <b>Subtotal Non-Construction Costs</b>                |   |                 |              |                   | \$ 32,192,418             |
| Project Contingency                                   |   |                 |              |                   | \$ 32,458,059             |
| Initiatives   |   |                 |              |                   | \$ 1,263,103              |
| <b>TOTAL INDIRECT NON-CONSTRUCTION COSTS</b>          |   |                 |              |                   | \$ 65,913,580             |
| <b>TOTAL PROJECT COST</b>                             |   |                 |              |                   | \$ 141,914,692            |

| Base Year | Estimate Year |
|-----------|---------------|
| 2020      | 2020          |

| Estimate - AACEI Class 5                            |   |          |       |                   |                           |
|---|---|----------|-------|-------------------|---------------------------|
| <b>Project Name:</b>                                | KC Class A Biosolids Tech Evaluation                      |          |       | <b>Date:</b>      | 1/2/2020                  |
| <b>Location:</b>                                    | West Point  |          |       | <b>Estimator:</b> | Steve Krugel and Trung Le |
| <b>Description:</b>                                 | MAD upgrades  |          |       | <b>Version:</b>   | Revision 01               |
| CONSTRUCTION COSTS                                  |   |          |       |                   |                           |
| Item No.  | Item Description  | Quantity | Units | Unit Cost         | Item Cost                 |
| 1   | MAD Digester - West Point (2 Additional 2.4 MG Digesters) | 4.80     | \$/MG | \$ 8,000,000.00   | \$ 38,400,000             |
| 2   |   |          |       |                   |                           |
| <b>Item Subtotal Construction Costs (Year 2020)</b> |   |          |       |                   | \$ 38,400,000             |
| DIRECT: CONSTRUCTION COST MARK-UPS                  |   |          |       |                   |                           |
|   | General Conditions  | 10%      |       | 1.1               | \$ 3,840,000              |
|   | Mobilization/Demobilization                               | 10%      |       | 1.1               | \$ 3,840,000              |
|   | Overhead & Profit (OHP)                                   | 8%       |       | 1.08              | \$ 3,072,000              |
|   | Insurance   | 1.5%     |       | 1.015             | \$ 576,000                |
|   | Bonding   | 1.0%     |       | 1.01              | \$ 384,000                |
|   | Escalation Multiplier from ENR-CCI                        | 0%       |       | 1.0000            | \$ -                      |
| <b>Item Subtotal Construction Costs (Year 2020)</b> |   |          |       |                   | \$ 50,112,000             |
| <b>Direct: Subtotal Construction Costs</b>          |   |          |       |                   | <b>\$ 50,112,000</b>      |

| Base Year | Estimate Year |
|-----------|---------------|
| 2020      | 2020          |

| Estimate - AACEI Class 5                              |   |                 |              |                   |  |               |
|---|---|-----------------|--------------|-------------------|--|---------------|
| <b>Project Name:</b>                                  | KC Class A Biosolids Tech Evaluation                        |                 |              | <b>Date:</b>      | 1/2/2020   |               |
| <b>Location:</b>                                      | South Plant   |                 |              | <b>Estimator:</b> | Steve Krugel and Trung Le                          |               |
| <b>Description:</b>                                   | <b>MAD upgrades</b>   |                 |              | <b>Version:</b>   | Revision 01  |               |
| <b>DIRECT: SUBTOTAL CONSTRUCTION COSTS</b>            |   |                 |              |                   |  |               |
| <b>Item No.</b>                                       | <b>Item Description</b>                                     | <b>Quantity</b> | <b>Units</b> | <b>Unit Cost</b>  | <b>Item Cost</b>                                   |               |
| 1   | MAD Digester - South Plant (1 Additional 2.75 MG Digesters) | 2.75            | \$/MG        | 8000000           | \$ 22,000,000                                      |               |
| 2   |   |                 |              |                   | \$ -   |               |
|   |   |                 |              |                   | <b>Construction Cost Markup</b>                    | \$ 6,710,000  |
|   |   |                 |              |                   | <b>Subtotal Construction Costs</b>                 | \$ 28,710,000 |
|   |   |                 |              |                   | Allowance for Indeterminates (Design Allowance)    | \$ 7,177,500  |
|   |   |                 |              |                   | Street Use Permit                                  | \$ -          |
|   |   |                 |              |                   | <b>ESTIMATED PROBABLE COST OF CONSTRUCTION BID</b> | \$ 35,887,500 |
| <b>DIRECT: SUBTOTAL ADDITIONAL CONSTRUCTION COSTS</b> |   |                 |              |                   |  |               |
|   |   |                 |              |                   | Mitigation Construction Contracts                  | \$ -          |
|   |   |                 |              |                   | Construction Change Order Allowance                | \$ 3,588,750  |
|   |   |                 |              |                   | Material Pricing Uncertainty Allowance             | \$ -          |
|   |   |                 |              |                   | <b>Subtotal Primary Construction Amount</b>        | \$ 39,476,250 |
|   |   |                 |              |                   | Construction Sales Tax                             | \$ 3,987,101  |
|   |   |                 |              |                   | Owner Furnished Equipment                          | \$ -          |
|   |   |                 |              |                   | Outside Agency Construction                        | \$ -          |
|   |   |                 |              |                   | <b>Subtotal KC Contribution to Construction</b>    | \$ 43,463,351 |
| <b>DIRECT: SUBTOTAL OTHER CAPITAL CHARGES</b>         |   |                 |              |                   |  |               |
|   |   |                 |              |                   | KC/WTD Direct Implementation                       | \$ -          |
|   |   |                 |              |                   | Misc. Capital Costs                                | \$ 78,953     |
|   |   |                 |              |                   | <b>TOTAL DIRECT CONSTRUCTION COSTS</b>             | \$ 43,542,000 |
| <b>INDIRECT: NON-CONSTRUCTION COSTS</b>               |   |                 |              |                   |  |               |
|   |   |                 |              |                   | Design and Construction Consulting                 | \$ 13,941,056 |
|   |   |                 |              |                   | Other Consulting Services                          | \$ -          |
|   |   |                 |              |                   | Permitting & Other Agency Support                  | \$ 394,763    |
|   |   |                 |              |                   | Right-of-Way                                       | \$ -          |
|   |   |                 |              |                   | Misc. Service & Materials                          | \$ 315,810    |
|   |   |                 |              |                   | Non-WTD Support                                    | \$ 335,548    |
|   |   |                 |              |                   | WTD Staff Labor                                    | \$ 4,851,334  |
|   |   |                 |              |                   | <b>Subtotal Non-Construction Costs</b>             | \$ 19,838,510 |
|   |   |                 |              |                   | Project Contingency                                | \$ 19,014,244 |
|   |   |                 |              |                   | Initiatives  | \$ 732,720    |
|   |   |                 |              |                   | <b>TOTAL INDIRECT NON-CONSTRUCTION COSTS</b>       | \$ 39,585,474 |
|   |   |                 |              |                   | <b>TOTAL PROJECT COST</b>                          | \$ 83,127,778 |

| Base Year | Estimate Year |
|-----------|---------------|
| 2020      | 2020          |



| Estimate - AACEI Class 5                            |   |          |       |                   |                           |
|---|---|----------|-------|-------------------|---------------------------|
| <b>Project Name:</b>                                | KC Class A Biosolids Tech Evaluation                        |          |       | <b>Date:</b>      | 1/2/2020                  |
| <b>Location:</b>                                    | South Plant   |          |       | <b>Estimator:</b> | Steve Krugel and Trung Le |
| <b>Description:</b>                                 | MAD upgrades  |          |       | <b>Version:</b>   | Revision 01               |
| CONSTRUCTION COSTS                                  |   |          |       |                   |                           |
| Item No.  | Item Description  | Quantity | Units | Unit Cost         | Item Cost                 |
| 1   | MAD Digester - South Plant (1 Additional 2.75 MG Digesters) | 2.75     | \$/MG | \$ 8,000,000.00   | \$ 22,000,000             |
| 2   |   |          |       |                   | \$ -                      |
| <b>Item Subtotal Construction Costs (Year 2020)</b> |   |          |       |                   | <b>\$ 22,000,000</b>      |
| DIRECT: CONSTRUCTION COST MARK-UPS                  |   |          |       |                   |                           |
|   | General Conditions  | 10%      |       | 1.1               | \$ 2,200,000              |
|   | Mobilization/Demobilization                                 | 10%      |       | 1.1               | \$ 2,200,000              |
|   | Overhead & Profit (OHP)                                     | 8%       |       | 1.08              | \$ 1,760,000              |
|   | Insurance   | 1.5%     |       | 1.015             | \$ 330,000                |
|   | Bonding   | 1.0%     |       | 1.01              | \$ 220,000                |
|   | Escalation Multiplier from ENR-CCI                          | 0%       |       | 1.0000            | \$ -                      |
| <b>Item Subtotal Construction Costs (Year 2020)</b> |   |          |       |                   | <b>\$ 28,710,000</b>      |
| <b>Direct: Subtotal Construction Costs</b>          |   |          |       |                   | <b>\$ 28,710,000</b>      |

| Base Year | Estimate Year |
|-----------|---------------|
| 2020      | 2020          |

| Base Year | Estimate Year |
|-----------|---------------|
| 2020      | 2020          |

| Estimate - AACEI Class 5                           |  |          |       |                   |                           |
|--|--|----------|-------|-------------------|---------------------------|
| <b>Project Name:</b>                               | KC Class A Biosolids Tech Evaluation                       |          |       | <b>Date:</b>      | 1/2/2020                  |
| <b>Location:</b>                                   | Brightwater  |          |       | <b>Estimator:</b> | Steve Krugel and Trung Le |
| <b>Description:</b>                                | <b>MAD Upgrades</b>  |          |       | <b>Version:</b>   | Revision 01               |
| DIRECT: SUBTOTAL CONSTRUCTION COSTS                |  |          |       |                   |                           |
| Item No.   | Item Description   | Quantity | Units | Unit Cost         | Item Cost                 |
| 1  | MAD Digester - Brightwater (1 Additional 1.25MG Digesters) | 1.25     | \$/MG | 8000000           | \$ 10,000,000             |
| 2  |  |          |       |                   | \$ -                      |
| <b>Construction Cost Markup</b>                    |  |          |       |                   | \$ 3,050,000              |
| <b>Subtotal Construction Costs</b>                 |  |          |       |                   | \$ 13,050,000             |
| Allowance for Indeterminates (Design Allowance)    |  |          |       |                   | \$ 3,262,500              |
| Street Use Permit                                  |  |          |       |                   | \$ -                      |
| <b>ESTIMATED PROBABLE COST OF CONSTRUCTION BID</b> |  |          |       |                   | \$ 16,312,500             |
| DIRECT: SUBTOTAL ADDITIONAL CONSTRUCTION COSTS     |  |          |       |                   |                           |
| Mitigation Construction Contracts                  |  |          |       |                   | \$ -                      |
| Construction Change Order Allowance                |  |          |       |                   | \$ 1,631,250              |
| Material Pricing Uncertainty Allowance             |  |          |       |                   | \$ -                      |
| <b>Subtotal Primary Construction Amount</b>        |  |          |       |                   | \$ 17,943,750             |
| Construction Sales Tax                             |  |          |       |                   | \$ 1,812,319              |
| Owner Furnished Equipment                          |  |          |       |                   | \$ -                      |
| Outside Agency Construction                        |  |          |       |                   | \$ -                      |
| <b>Subtotal KC Contribution to Construction</b>    |  |          |       |                   | \$ 19,756,069             |
| DIRECT: SUBTOTAL OTHER CAPITAL CHARGES             |  |          |       |                   |                           |
| KC/WTD Direct Implementation                       |  |          |       |                   | \$ -                      |
| Misc. Capital Costs                                |  |          |       |                   | \$ 35,888                 |
| <b>TOTAL DIRECT CONSTRUCTION COSTS</b>             |  |          |       |                   | \$ 19,792,000             |
| INDIRECT: NON-CONSTRUCTION COSTS                   |  |          |       |                   |                           |
| Design and Construction Consulting                 |  |          |       |                   | \$ 7,109,830              |
| Other Consulting Services                          |  |          |       |                   | \$ -                      |
| Permitting & Other Agency Support                  |  |          |       |                   | \$ 179,438                |
| Right-of-Way                                       |  |          |       |                   | \$ -                      |
| Misc. Service & Materials                          |  |          |       |                   | \$ 143,550                |
| Non-WTD Support                                    |  |          |       |                   | \$ 152,522                |
| WTD Staff Labor                                    |  |          |       |                   | \$ 2,437,165              |
| <b>Subtotal Non-Construction Costs</b>             |  |          |       |                   | \$ 10,022,504             |
| Project Contingency                                |  |          |       |                   | \$ 8,944,338              |
| Initiatives  |  |          |       |                   | \$ 339,587                |
| <b>TOTAL INDIRECT NON-CONSTRUCTION COSTS</b>       |  |          |       |                   | \$ 19,306,430             |
| <b>TOTAL PROJECT COST</b>                          |  |          |       |                   | \$ 39,098,386             |

| Estimate - AACEI Class 5                            |  |          |       |                   |                           |
|---|--|----------|-------|-------------------|---------------------------|
| <b>Project Name:</b>                                | KC Class A Biosolids Tech Evaluation                       |          |       | <b>Date:</b>      | 1/2/2020                  |
| <b>Location:</b>                                    | Brightwater  |          |       | <b>Estimator:</b> | Steve Krugel and Trung Le |
| <b>Description:</b>                                 | MAD Upgrades   |          |       | <b>Version:</b>   | Revision 01               |
| CONSTRUCTION COSTS                                  |  |          |       |                   |                           |
| Item No.  | Item Description   | Quantity | Units | Unit Cost         | Item Cost                 |
| 1   | MAD Digester - Brightwater (1 Additional 1.25MG Digesters) | 1.3      | \$/MG | \$ 8,000,000.00   | \$ 10,000,000             |
| 2   |  |          |       |                   | \$ -                      |
| <b>Item Subtotal Construction Costs (Year 2020)</b> |  |          |       |                   | <b>\$ 10,000,000</b>      |
| DIRECT: CONSTRUCTION COST MARK-UPS                  |  |          |       |                   |                           |
|   | General Conditions   | 10%      |       | 1.1               | \$ 1,000,000              |
|   | Mobilization/Demobilization                                | 10%      |       | 1.1               | \$ 1,000,000              |
|   | Overhead & Profit (OHP)                                    | 8%       |       | 1.08              | \$ 800,000                |
|   | Insurance  | 1.5%     |       | 1.015             | \$ 150,000                |
|   | Bonding  | 1.0%     |       | 1.01              | \$ 100,000                |
|   | Escalation Multiplier from ENR-CCI                         | 0%       |       | 1.0000            | \$ -                      |
| <b>Item Subtotal Construction Costs (Year 2020)</b> |  |          |       |                   | <b>\$ 13,050,000</b>      |
| <b>Direct: Subtotal Construction Costs</b>          |  |          |       |                   | <b>\$ 13,050,000</b>      |

| Base Year | Estimate Year |
|-----------|---------------|
| 2020      | 2020          |

| Estimate - AACEI Class 5                              |                                      |                 |              |                   |                           |
|---|--------------------------------------|-----------------|--------------|-------------------|---------------------------|
| <b>Project Name:</b>                                  | KC Class A Biosolids Tech Evaluation |                 |              | <b>Date:</b>      | 1/2/2020                  |
| <b>Location:</b>                                      | West Point                           |                 |              | <b>Estimator:</b> | Steve Krugel and Trung Le |
| <b>Description:</b>                                   | TAD System at West Point             |                 |              | <b>Version:</b>   | Revision 01               |
| <b>DIRECT: SUBTOTAL CONSTRUCTION COSTS</b>            |                                      |                 |              |                   |                           |
| <b>Item No.</b>                                       | <b>Item Description</b>              | <b>Quantity</b> | <b>Units</b> | <b>Unit Cost</b>  | <b>Item Cost</b>          |
| 1   | MAD to TAD Digester Upgrades         | 1               | LS           | 16900000          | \$ 16,900,000             |
| 2   | TAD Batch Tanks                      | 1               | LS           | 19200000          | \$ 19,200,000             |
| 3   |                                      |                 |              |                   | \$ -                      |
| <b>Construction Cost Markup</b>                       |                                      |                 |              |                   | \$ 11,010,500             |
| <b>Subtotal Construction Costs</b>                    |                                      |                 |              |                   | \$ 47,110,500             |
| Allowance for Indeterminates (Design Allowance)       |                                      |                 |              |                   | \$ 9,422,100              |
| Street Use Permit                                     |                                      |                 |              |                   | \$ -                      |
| <b>ESTIMATED PROBABLE COST OF CONSTRUCTION BID</b>    |                                      |                 |              |                   | \$ 56,532,600             |
| <b>DIRECT: SUBTOTAL ADDITIONAL CONSTRUCTION COSTS</b> |                                      |                 |              |                   |                           |
| Mitigation Construction Contracts                     |                                      |                 |              |                   | \$ -                      |
| Construction Change Order Allowance                   |                                      |                 |              |                   | \$ 5,653,260              |
| Material Pricing Uncertainty Allowance                |                                      |                 |              |                   | \$ -                      |
| <b>Subtotal Primary Construction Amount</b>           |                                      |                 |              |                   | \$ 62,185,860             |
| Construction Sales Tax                                |                                      |                 |              |                   | \$ 6,280,772              |
| Owner Furnished Equipment                             |                                      |                 |              |                   | \$ -                      |
| Outside Agency Construction                           |                                      |                 |              |                   | \$ -                      |
| <b>Subtotal KC Contribution to Construction</b>       |                                      |                 |              |                   | \$ 68,466,632             |
| <b>DIRECT: SUBTOTAL OTHER CAPITAL CHARGES</b>         |                                      |                 |              |                   |                           |
| KC/WTD Direct Implementation                          |                                      |                 |              |                   | \$ -                      |
| Misc. Capital Costs                                   |                                      |                 |              |                   | \$ 124,372                |
| <b>TOTAL DIRECT CONSTRUCTION COSTS</b>                |                                      |                 |              |                   | \$ 68,591,000             |
| <b>INDIRECT: NON-CONSTRUCTION COSTS</b>               |                                      |                 |              |                   |                           |
| Design and Construction Consulting                    |                                      |                 |              |                   | \$ 20,557,872             |
| Other Consulting Services                             |                                      |                 |              |                   | \$ -                      |
| Permitting & Other Agency Support                     |                                      |                 |              |                   | \$ 621,859                |
| Right-of-Way  |                                      |                 |              |                   | \$ -                      |
| Misc. Service & Materials                             |                                      |                 |              |                   | \$ 497,487                |
| Non-WTD Support                                       |                                      |                 |              |                   | \$ 528,580                |
| WTD Staff Labor                                       |                                      |                 |              |                   | \$ 7,237,417              |
| <b>Subtotal Non-Construction Costs</b>                |                                      |                 |              |                   | \$ 29,443,215             |
| Project Contingency                                   |                                      |                 |              |                   | \$ 29,410,265             |
| Initiatives   |                                      |                 |              |                   | \$ 1,142,483              |
| <b>TOTAL INDIRECT NON-CONSTRUCTION COSTS</b>          |                                      |                 |              |                   | \$ 59,995,963             |
| <b>TOTAL PROJECT COST</b>                             |                                      |                 |              |                   | \$ 128,586,966            |

| Base Year | Estimate Year |
|-----------|---------------|
| 2020      | 2020          |

| Estimate - AACEI Class 5                              |                                      |                 |              |                   |                           |
|---|--------------------------------------|-----------------|--------------|-------------------|---------------------------|
| <b>Project Name:</b>                                  | KC Class A Biosolids Tech Evaluation |                 |              | <b>Date:</b>      | 1/2/2020                  |
| <b>Location:</b>                                      | South Plant                          |                 |              | <b>Estimator:</b> | Steve Krugel and Trung Le |
| <b>Description:</b>                                   | TAD System at South Plant            |                 |              | <b>Version:</b>   | Revision 01               |
| <b>DIRECT: SUBTOTAL CONSTRUCTION COSTS</b>            |                                      |                 |              |                   |                           |
| <b>Item No.</b>                                       | <b>Item Description</b>              | <b>Quantity</b> | <b>Units</b> | <b>Unit Cost</b>  | <b>Item Cost</b>          |
| 1   | MAD to TAD Digester Upgrades         | 1               | LS           | 13920000          | \$ 13,920,000             |
| 2   | TAD Batch Tanks                      | 1               | LS           | 18360000          | \$ 18,360,000             |
| 3   |                                      |                 |              |                   | \$ -                      |
| <b>Construction Cost Markup</b>                       |                                      |                 |              |                   | \$ 9,845,400              |
| <b>Subtotal Construction Costs</b>                    |                                      |                 |              |                   | \$ 42,125,400             |
| Allowance for Indeterminates (Design Allowance)       |                                      |                 |              |                   | \$ 8,425,080              |
| Street Use Permit                                     |                                      |                 |              |                   | \$ -                      |
| <b>ESTIMATED PROBABLE COST OF CONSTRUCTION BID</b>    |                                      |                 |              |                   | \$ 50,550,480             |
| <b>DIRECT: SUBTOTAL ADDITIONAL CONSTRUCTION COSTS</b> |                                      |                 |              |                   |                           |
| Mitigation Construction Contracts                     |                                      |                 |              |                   | \$ -                      |
| Construction Change Order Allowance                   |                                      |                 |              |                   | \$ 5,055,048              |
| Material Pricing Uncertainty Allowance                |                                      |                 |              |                   | \$ -                      |
| <b>Subtotal Primary Construction Amount</b>           |                                      |                 |              |                   | \$ 55,605,528             |
| Construction Sales Tax                                |                                      |                 |              |                   | \$ 5,616,158              |
| Owner Furnished Equipment                             |                                      |                 |              |                   | \$ -                      |
| Outside Agency Construction                           |                                      |                 |              |                   | \$ -                      |
| <b>Subtotal KC Contribution to Construction</b>       |                                      |                 |              |                   | \$ 61,221,686             |
| <b>DIRECT: SUBTOTAL OTHER CAPITAL CHARGES</b>         |                                      |                 |              |                   |                           |
| KC/WTD Direct Implementation                          |                                      |                 |              |                   | \$ -                      |
| Misc. Capital Costs                                   |                                      |                 |              |                   | \$ 111,211                |
| <b>TOTAL DIRECT CONSTRUCTION COSTS</b>                |                                      |                 |              |                   | \$ 61,333,000             |
| <b>INDIRECT: NON-CONSTRUCTION COSTS</b>               |                                      |                 |              |                   |                           |
| Design and Construction Consulting                    |                                      |                 |              |                   | \$ 18,683,252             |
| Other Consulting Services                             |                                      |                 |              |                   | \$ -                      |
| Permitting & Other Agency Support                     |                                      |                 |              |                   | \$ 556,055                |
| Right-of-Way  |                                      |                 |              |                   | \$ -                      |
| Misc. Service & Materials                             |                                      |                 |              |                   | \$ 444,844                |
| Non-WTD Support                                       |                                      |                 |              |                   | \$ 472,647                |
| WTD Staff Labor                                       |                                      |                 |              |                   | \$ 6,557,411              |
| <b>Subtotal Non-Construction Costs</b>                |                                      |                 |              |                   | \$ 26,714,209             |
| Project Contingency                                   |                                      |                 |              |                   | \$ 26,414,132             |
| Initiatives   |                                      |                 |              |                   | \$ 1,024,101              |
| <b>TOTAL INDIRECT NON-CONSTRUCTION COSTS</b>          |                                      |                 |              |                   | \$ 54,152,443             |
| <b>TOTAL PROJECT COST</b>                             |                                      |                 |              |                   | \$ 115,485,340            |

| Base Year | Estimate Year |
|-----------|---------------|
| 2020      | 2020          |

|           |               |
|-----------|---------------|
| Base Year | Estimate Year |
| 2020      | 2020          |

| Estimate - AACEI Class 5                                  |  |   |       |               |           |                   |
|---|--|---|-------|---------------|-----------|-------------------|
| <b>Project Name:</b> KC Class A Biosolids Tech Evaluation |  | <b>Date:</b> 1/2/2020                       |       |               |           |                   |
| <b>Location:</b> South Plant                              |  | <b>Estimator:</b> Steve Krugel and Trung Le |       |               |           |                   |
| <b>Description:</b> TAD System at South Plant             |  | <b>Version:</b> Revision 01                 |       |               |           |                   |
| CONSTRUCTION COSTS  |  |   |       |               |           |                   |
| Item No.  | Item Description   | Quantity                                    | Units | Unit Cost     | Item Cost |                   |
| 1   | MAD to TAD Digester Upgrades                                       | 1.0   | LS    | \$ 13,920,000 | \$        | 13,920,000        |
| 2   | Floating Cover to Fixed Cover Upgrade                              | 4.0   | EA    | \$ 1,000,000  | \$        | 4,000,000         |
| 3   | Heat Exchanger Upgrades  | 4.0   | EA    | \$ 300,000    | \$        | 1,200,000         |
| 4   | Boiler upsize  | 2.0   | EA    | \$ 1,000,000  | \$        | 2,000,000         |
| 5   | Digester Cleaning, Repairs, and General Upgrades, and New Mixing ( | 4.0   | EA    | \$ 1,680,000  | \$        | 6,720,000         |
| 6   | TAD Batch Tanks  | 1.0   | LS    | \$ 18,360,000 | \$        | 18,360,000        |
| 7   | Batch tanks  | 1.5   | \$/MG | \$ 12,000,000 | \$        | 18,360,000        |
| 8   |  |   |       |               | \$        | -                 |
| <b>Item Subtotal Construction Costs (Year 2020)</b>       |  |   |       |               | \$        | 32,280,000        |
| DIRECT: CONSTRUCTION COST MARK-UPS                        |  |   |       |               |           |                   |
| General Conditions  |  | 10%   |       | 1.1           | \$        | 3,228,000         |
| Mobilization/Demobilization                               |  | 10%   |       | 1.1           | \$        | 3,228,000         |
| Overhead & Profit (OHP)                                   |  | 8%  |       | 1.08          | \$        | 2,582,400         |
| Insurance   |  | 1.5%  |       | 1.015         | \$        | 484,200           |
| Bonding   |  | 1.0%  |       | 1.01          | \$        | 322,800           |
| Escalation Multiplier from ENR-CCI                        |  | 0%  |       | 1.0000        | \$        | -                 |
| <b>Item Subtotal Construction Costs (Year 2020)</b>       |  |   |       |               | \$        | 42,125,400        |
| <b>Direct: Subtotal Construction Costs</b>                |  |   |       |               | \$        | <b>42,125,000</b> |

| Estimate - AACEI Class 5                           |                                      |          |       |                   |                           |
|--|--------------------------------------|----------|-------|-------------------|---------------------------|
| <b>Project Name:</b>                               | KC Class A Biosolids Tech Evaluation |          |       | <b>Date:</b>      | 1/2/2020                  |
| <b>Location:</b>                                   | South Treatment Plant                |          |       | <b>Estimator:</b> | Steve Krugel and Trung Le |
| <b>Description:</b>                                | THP-MAD System at South Plant        |          |       | <b>Version:</b>   | Revision 01               |
| DIRECT: SUBTOTAL CONSTRUCTION COSTS                |                                      |          |       |                   |                           |
| Item No.   | Item Description                     | Quantity | Units | Unit Cost         | Item Cost                 |
| 1  | THP-MAD Digester Upgrades            | 1        | LS    | 10720000          | \$ 10,720,000             |
| 2  | Solids Screening and Pre-dewatering  | 1        | LS    | 84000000          | \$ 84,000,000             |
| 3  | Thermal Hydrolysis (CAMBI)           | 1        | LS    | 53200000          | \$ 53,200,000             |
| 4  | Steam Boilers                        | 1        | LS    | 7910000           | \$ 7,910,000              |
| 5  | Cooling Towers                       | 1        | LS    | 4690000           | \$ 4,690,000              |
| 6  |                                      |          |       |                   | \$ -                      |
| <b>Construction Cost Markup</b>                    |                                      |          |       |                   | \$ 48,958,600             |
| <b>Subtotal Construction Costs</b>                 |                                      |          |       |                   | \$ 209,478,600            |
| Allowance for Indeterminates (Design Allowance)    |                                      |          |       |                   | \$ 31,421,790             |
| Street Use Permit                                  |                                      |          |       |                   | \$ -                      |
| <b>ESTIMATED PROBABLE COST OF CONSTRUCTION BID</b> |                                      |          |       |                   | \$ 240,900,390            |
| DIRECT: SUBTOTAL ADDITIONAL CONSTRUCTION COSTS     |                                      |          |       |                   |                           |
| Mitigation Construction Contracts                  |                                      |          |       |                   | \$ -                      |
| Construction Change Order Allowance                |                                      |          |       |                   | \$ 24,090,039             |
| Material Pricing Uncertainty Allowance             |                                      |          |       |                   | \$ -                      |
| <b>Subtotal Primary Construction Amount</b>        |                                      |          |       |                   | \$ 264,990,429            |
| Construction Sales Tax                             |                                      |          |       |                   | \$ 26,764,033             |
| Owner Furnished Equipment                          |                                      |          |       |                   | \$ -                      |
| Outside Agency Construction                        |                                      |          |       |                   | \$ -                      |
| <b>Subtotal KC Contribution to Construction</b>    |                                      |          |       |                   | \$ 291,754,462            |
| DIRECT: SUBTOTAL OTHER CAPITAL CHARGES             |                                      |          |       |                   |                           |
| KC/WTD Direct Implementation                       |                                      |          |       |                   | \$ -                      |
| Misc. Capital Costs                                |                                      |          |       |                   | \$ 529,981                |
| <b>TOTAL DIRECT CONSTRUCTION COSTS</b>             |                                      |          |       |                   | \$ 292,284,000            |
| INDIRECT: NON-CONSTRUCTION COSTS                   |                                      |          |       |                   |                           |
| Design and Construction Consulting                 |                                      |          |       |                   | \$ 71,072,436             |
| Other Consulting Services                          |                                      |          |       |                   | \$ -                      |
| Permitting & Other Agency Support                  |                                      |          |       |                   | \$ 2,649,904              |
| Right-of-Way                                       |                                      |          |       |                   | \$ -                      |
| Misc. Service & Materials                          |                                      |          |       |                   | \$ 2,119,923              |
| Non-WTD Support                                    |                                      |          |       |                   | \$ 2,252,419              |
| WTD Staff Labor                                    |                                      |          |       |                   | \$ 26,324,583             |
| <b>Subtotal Non-Construction Costs</b>             |                                      |          |       |                   | \$ 104,419,266            |
| Project Contingency                                |                                      |          |       |                   | \$ 119,011,113            |
| Initiatives  |                                      |          |       |                   | \$ 4,731,621              |
| <b>TOTAL INDIRECT NON-CONSTRUCTION COSTS</b>       |                                      |          |       |                   | \$ 228,162,000            |
| <b>TOTAL PROJECT COST</b>                          |                                      |          |       |                   | \$ 520,446,443            |

| Base Year | Estimate Year |
|-----------|---------------|
| 2019      | 2020          |



|                  |                      |
|------------------|----------------------|
| <b>Base Year</b> | <b>Estimate Year</b> |
| 2019             | 2020                 |

| Estimate - AACEI Class 5                            |   |          |       |                   |                           |
|---|---|----------|-------|-------------------|---------------------------|
| <b>Project Name:</b>                                | KC Class A Biosolids Tech Evaluation  |          |       | <b>Date:</b>      | 1/2/2020                  |
| <b>Location:</b>                                    | South Treatment Plant   |          |       | <b>Estimator:</b> | Steve Krugel and Trung Le |
| <b>Description:</b>                                 | THP-MAD System at South Plant   |          |       | <b>Version:</b>   | Revision 01               |
| CONSTRUCTION COSTS                                  |   |          |       |                   |                           |
| Item No.  | Item Description  | Quantity | Units | Unit Cost         | Item Cost                 |
| 1   | THP-MAD Digester Upgrades   | 1        | LS    | \$ 10,720,000.00  | \$ 10,720,000             |
| 2   | Floating Cover to Fixed Cover Upgrade   | 4        | EA    | \$ 1,000,000.00   | \$ 4,000,000              |
| 3   | Digester Cleaning, Repairs, and General Upgrades, and New Mixing (Draft Tube) | 4        | EA    | \$ 1,680,000.00   | \$ 6,720,000              |
| 4   | Solids Screening and Pre-dewatering   | 1        | LS    | \$ 84,000,000.00  | \$ 84,000,000             |
| 5   | Thermal Hydrolysis (CAMBI)  | 1        | LS    | \$ 53,200,000.00  | \$ 53,200,000             |
| 6   | Steam Boilers   | 1        | LS    | \$ 7,910,000.00   | \$ 7,910,000              |
| 7   | Cooling Towers  | 1        | LS    | \$ 4,690,000.00   | \$ 4,690,000              |
| <b>Item Subtotal Construction Costs (Year 2020)</b> |   |          |       |                   | \$ 160,520,000            |
| DIRECT: CONSTRUCTION COST MARK-UPS                  |   |          |       |                   |                           |
|   | General Conditions  | 10%      |       | 1.1               | \$ 16,052,000             |
|   | Mobilization/Demobilization   | 10%      |       | 1.1               | \$ 16,052,000             |
|   | Overhead & Profit (OHP)   | 8%       |       | 1.08              | \$ 12,841,600             |
|   | Insurance   | 1.5%     |       | 1.015             | \$ 2,407,800              |
|   | Bonding   | 1.0%     |       | 1.01              | \$ 1,605,200              |
|   | Escalation Multiplier from ENR-CCI  | 0%       |       | 1.0000            | \$ -                      |
| <b>Item Subtotal Construction Costs (Year 2020)</b> |   |          |       |                   | \$ 209,478,600            |
| <b>Direct: Subtotal Construction Costs</b>          |   |          |       |                   | \$ <b>209,479,000</b>     |

| Estimate - AACEI Class 5                           |   |          |       |                   |                       |
|--|---|----------|-------|-------------------|-----------------------|
| <b>Project Name:</b>                               | KC Class A Biosolids Tech Evaluation  |          |       | <b>Date:</b>      | 12/30/2019            |
| <b>Location:</b>                                   | King County - South End, Site To be Determined                                      |          |       | <b>Estimator:</b> | Trung Le              |
| <b>Description:</b>                                | ASP Composting Facility   |          |       | <b>Version:</b>   | Revision 01           |
| DIRECT: SUBTOTAL CONSTRUCTION COSTS                |   |          |       |                   |                       |
| Item No.   | Item Description  | Quantity | Units | Unit Cost         | Item Cost             |
| 1  | Primary Composting  | 44,018   | SF    | \$ 157            | \$ 6,905,580          |
| 2  | Secondary Composting  | 69,728   | SF    | \$ 125            | \$ 8,747,068          |
| 3  | Process/Maintenance Buildings   | 67,750   | SF    | \$ 75             | \$ 5,081,231          |
| 4  | Office/Administration Building  | 7,500    | SF    | \$ 150            | \$ 1,125,000          |
| 5  | Admin Parking, Roads, Truck Access, Maintenance Yard, Curing and Storage, Screening | 178,153  | SF    | \$ 8              | \$ 1,425,221          |
| 6  | Dry Wood Storage  | 26,999   | SF    | \$ 25             | \$ 674,963            |
| 7  | Ponds and Collection System   | 111,409  | SF    | \$ 20             | \$ 2,228,184          |
| 8  | Equipment Purchases (ECS)   | 1        | LS    | \$ 1,955,000      | \$ 1,955,000          |
| 9  | Install Equipment Purchases (ECS)   | 1        | LS    | \$ 1,225,000      | \$ 1,225,000          |
| 10   | Site Preparation / Demolition   | 629,055  | SF    | \$ 1              | \$ 933,091            |
| 11   | Site Mass Grading (whole site using avg. of 2.5' of cut to fill)                    | 58,246   | CY    | \$ 5              | \$ 262,106            |
| 12   | Water / Sewer / Electrical Services to Site   | 1        | LS    | \$ 250,000        | \$ 312,500            |
| 13   | Site Perimeter - Chain Link Fencing   | 4,496    | LF    | \$ 30             | \$ 133,995            |
| 14   | Site Perimeter - New Landscape  | 170,023  | SF    | \$ 8              | \$ 1,428,194          |
| <b>Construction Cost Markup</b>                    |   |          |       |                   | \$ 9,893,326          |
| <b>Subtotal Construction Costs</b>                 |   |          |       |                   | \$ <b>42,330,460</b>  |
| Allowance for Indeterminates (Design Allowance)    |   |          |       |                   | \$ 11,288,865         |
| Street Use Permit                                  |   |          |       |                   | \$ -                  |
| <b>ESTIMATED PROBABLE COST OF CONSTRUCTION BID</b> |   |          |       |                   | \$ <b>53,619,325</b>  |
| DIRECT: SUBTOTAL ADDITIONAL CONSTRUCTION COSTS     |   |          |       |                   |                       |
| Mitigation Construction Contracts                  |   |          |       |                   | \$ -                  |
| Construction Change Order Allowance                |   |          |       |                   | \$ 5,644,432          |
| Material Pricing Uncertainty Allowance             |   |          |       |                   | \$ -                  |
| <b>Subtotal Primary Construction Amount</b>        |   |          |       |                   | \$ <b>59,263,757</b>  |
| Construction Sales Tax                             |   |          |       |                   | \$ 5,985,639          |
| Owner Furnished Equipment                          |   |          |       |                   | \$ 2,825,000          |
| Outside Agency Construction                        |   |          |       |                   | \$ -                  |
| <b>Subtotal KC Contribution to Construction</b>    |   |          |       |                   | \$ <b>68,074,396</b>  |
| DIRECT: SUBTOTAL OTHER CAPITAL CHARGES             |   |          |       |                   |                       |
| KC/WTD Direct Implementation                       |   |          |       |                   | \$ -                  |
| Misc. Capital Costs                                |   |          |       |                   | \$ 124,178            |
| <b>TOTAL DIRECT CONSTRUCTION COSTS</b>             |   |          |       |                   | \$ <b>68,199,000</b>  |
| INDIRECT: NON-CONSTRUCTION COSTS                   |   |          |       |                   |                       |
| Design and Construction Consulting                 |   |          |       |                   | \$ 14,228,182         |
| Other Consulting Services                          |   |          |       |                   | \$ -                  |
| Permitting & Other Agency Support                  |   |          |       |                   | \$ 310,444            |
| Right-of-Way                                       |   |          |       |                   | \$ -                  |
| Misc. Service & Materials                          |   |          |       |                   | \$ 1,117,598          |
| Non-WTD Support                                    |   |          |       |                   | \$ 527,754            |
| WTD Staff Labor                                    |   |          |       |                   | \$ 6,941,389          |
| <b>Subtotal Non-Construction Costs</b>             |   |          |       |                   | \$ <b>23,125,367</b>  |
| Project Contingency                                |   |          |       |                   | \$ 27,482,780         |
| Initiatives  |   |          |       |                   | \$ 1,099,310          |
| <b>TOTAL INDIRECT NON-CONSTRUCTION COSTS</b>       |   |          |       |                   | \$ <b>51,707,457</b>  |
| <b>TOTAL PROJECT COST</b>                          |   |          |       |                   | \$ <b>119,906,031</b> |

| Base Year | Estimate Year |
|-----------|---------------|
| 2020      | 2020          |

| Base Year | Estimate Year |
|-----------|---------------|
| 2020      | 2020          |

| Estimate - AACEI Class 5                            |   |  |           |                 |                      |
|---|---|--|-----------|-----------------|----------------------|
| Project Name:                                       |   | KC Class A Biosolids Tech Evaluation           |           | Date:           | 12/30/2019           |
| Location:   |   | King County - South End, Site To be Determined |           | Estimator:      | Trung Le             |
| Description:  |   | ASP Composting Facility                        |           | Version:        | Revision 01          |
| CONSTRUCTION COSTS                                  |   |  |           |                 |                      |
| Item No.  | Item Description  | Quantity                                       | Units     | Unit Cost       | Item Cost            |
| 1   | <b>Primary Composting</b>   | <b>44,018</b>                                  | <b>SF</b> | \$ 156.88       | \$ <b>6,905,580</b>  |
| 2   | Primary Compost Process Area  | 1  | LS        | \$ -            | \$ -                 |
| 3   | <b>Secondary Composting</b>   | <b>69,728</b>                                  | <b>SF</b> | \$ 125.45       | \$ <b>8,747,068</b>  |
| 4   | Secondary ASP Area  | 1  | LS        | \$ -            | \$ -                 |
| 5   | <b>Process/Maintenance Buildings</b>                                    | <b>67,750</b>                                  | <b>SF</b> | \$ 75.00        | \$ <b>5,081,231</b>  |
| 6   | Pre-process & Tip Building  | 44,821   | SF        | \$ 75.00        | \$ 3,361,594         |
| 7   | Maintenance Building  | 5,000  | SF        | \$ 75.00        | \$ 375,000           |
| 8   | Bagging Building  | 17,929   | SF        | \$ 75.00        | \$ 1,344,638         |
| 9   | <b>Office/Administration Building</b>                                   | <b>7,500</b>                                   | <b>SF</b> | \$ 150.00       | \$ <b>1,125,000</b>  |
|   | Admin Parking, Roads, Truck Access, Maintenance Yard, Curing and        |  |           | \$ 8.00         |                      |
| 10  | <b>Storage, Screening</b>   | <b>178,153</b>                                 | <b>SF</b> |                 | \$ <b>1,425,221</b>  |
| 11  | Admin Parking   | 2,500  | SF        | \$ 8.00         | \$ 20,000            |
| 12  | Roads   | 59,112   | SF        | \$ 8.00         | \$ 472,896           |
| 13  | Truck Access  | 26,893   | SF        | \$ 8.00         | \$ 215,142           |
| 14  | Maintenance Yard  | 8,964  | SF        | \$ 8.00         | \$ 71,714            |
| 15  | Screening Area  | 13,446   | SF        | \$ 8.00         | \$ 107,571           |
| 16  | Curing and Storage Area   | 67,237   | SF        | \$ 8.00         | \$ 537,898           |
| 17  | <b>Dry Wood Storage</b>   | <b>26,999</b>                                  | <b>SF</b> | \$ 25.00        | \$ <b>674,963</b>    |
| 18  | <b>Ponds and Collection System</b>                                      | <b>111,409</b>                                 | <b>SF</b> | \$ 20.00        | \$ <b>2,228,184</b>  |
| 19  | Contact Water Pond and Collection System                                | 36,409   | SF        | \$ 15.00        | \$ 546,138           |
| 20  | Storm water Pond  | 75,000   | SF        | \$ 5.00         | \$ 375,000           |
| 21  | <b>Equipment Purchases (ECS)</b>  | <b>1</b>                                       | <b>LS</b> | \$ 1,955,000.00 | \$ <b>1,955,000</b>  |
| 22  | Wood Grinder (mid-large Horizontal)                                     | 1  | EA        | \$ 500,000.00   | \$ 500,000           |
| 23  | Mixer System (ECS/LuckNow 2295)   | 2  | EA        | \$ 260,000.00   | \$ 520,000           |
| 24  | Screen (MultiStar L3 Type)  | 1  | EA        | \$ 550,000.00   | \$ 550,000           |
| 25  | Bagging Equipment (RotoChopper Go-Bagger 250)                           | 2  | EA        | \$ 60,000.00    | \$ 120,000           |
| 26  | Radial Stacking Conveyors   | 3  | EA        | \$ 195,000.00   | \$ 585,000           |
| 27  | <b>Install Equipment Purchases (ECS)</b>                                | <b>1</b>                                       | <b>LS</b> | \$ 1,225,000.00 | \$ <b>1,225,000</b>  |
| 28  | Install Mixer System (ECS/LuckNow 2295)                                 | 2  | EA        | \$ 520,000.00   | \$ 1,040,000         |
| 29  | Install Bagging Equipment (RotoChopper Go-Bagger 250)                   | 1  | EA        | \$ 120,000.00   | \$ 120,000           |
| 30  | Install Radial Stacking Conveyors                                       | 3  | EA        | \$ 195,000.00   | \$ 585,000           |
| 31  | <b>Site Preparation / Demolition</b>                                    | <b>629,055</b>                                 | <b>SF</b> | \$ 1.48         | \$ <b>933,091</b>    |
| 32  | Demo Existing Building (1/4 of site size)                               | 1,315,759                                      | CF        | \$ 0.50         | \$ 657,879           |
| 33  | Demo Existing Hard Surfaces (1/2 of site size)                          | 314,528  | SF        | \$ 0.75         | \$ 235,896           |
| 34  | Demo Existing Landscape/Trees (1/4 of site size)                        | 157,264  | SF        | \$ 0.25         | \$ 39,316            |
| 35  | <b>Site Mass Grading (whole site using avg. of 2.5' of cut to fill)</b> | <b>58,246</b>                                  | <b>CY</b> | \$ 4.50         | \$ <b>262,106</b>    |
| 36  | <b>Water / Sewer / Electrical Services to Site</b>                      | <b>1</b>                                       | <b>LS</b> | \$ 250,000.00   | \$ <b>312,500</b>    |
| 37  | <b>Site Perimeter - Chain Link Fencing</b>                              | <b>4,496</b>                                   | <b>LF</b> | \$ 29.80        | \$ <b>133,995</b>    |
| 38  | <b>Site Perimeter - New Landscape</b>                                   | <b>170,023</b>                                 | <b>SF</b> | \$ 8.40         | \$ <b>1,428,194</b>  |
| <b>Item Subtotal Construction Costs (Year 2020)</b> |   |  |           |                 | \$ <b>32,437,134</b> |
| <b>DIRECT: CONSTRUCTION COST MARK-UPS</b>           |   |  |           |                 |                      |
|   | General Conditions  | 10%  |           | 1.1             | \$ 3,243,713.38      |
|   | Mobilization/Demobilization   | 10%  |           | 1.1             | \$ 3,243,713.38      |
|   | Overhead & Profit (OHP)   | 8%   |           | 1.08            | \$ 2,594,970.71      |
|   | Insurance   | 1.5%   |           | 1.015           | \$ 486,557.01        |
|   | Bonding   | 1.0%   |           | 1.01            | \$ 324,371.34        |
|   | Escalation Multiplier from ENR-CCI                                      | 0%   |           | 1.0000          | \$ -                 |
| <b>Item Subtotal Construction Costs (Year 2020)</b> |   |  |           |                 | \$ <b>42,330,460</b> |
| <b>Direct: Subtotal Construction Costs</b>          |   |  |           |                 | \$ <b>42,330,000</b> |

| <b>Estimate - AACEI Class 5</b>                 |  |          |                   |              |                     |
|---|--|----------|-------------------|--------------|---------------------|
| <b>Project Name:</b>                            | KC Class A Biosolids Tech Evaluation           |          | <b>Date:</b>      | 12/30/2019   |                     |
| <b>Location:</b>                                | King County - South End, Site To be Determined |          | <b>Estimator:</b> | Trung Le     |                     |
| <b>Description:</b>                             | ASP Composting Facility                        |          | <b>Version:</b>   | Revision 01  |                     |
| <b>CONSTRUCTION COSTS</b>                       |  |          |                   |              |                     |
| Item No.  | Item Description                               | Quantity | Units             | Unit Cost    | Item Cost           |
| 1   | <b>Equipment Purchases (ECS)</b>               | 1        | LS                | \$ 2,825,040 | \$ 2,825,040        |
| 2   | Large Front End Loader (Cat 980, Type)         | 4        | EA                | \$ 550,000   | \$ 2,200,000        |
| 3   | Small Front End Loader (Cat 950, Type)         | 1        | EA                | \$ 300,000   | \$ 300,000          |
| 4   | Compost Turner (X67 Type)                      | 0        | EA                | \$ 600,000   | \$ -                |
| 5   | Forklift                                       | 1        | EA                | \$ 50,000    | \$ 50,000           |
| 6   | Repair Shop Tools                              | 1        | LS                | \$ 200,000   | \$ 200,000          |
| 7   | Sport Utility Vehicle                          | 1        | EA                | \$ 36,960    | \$ 36,960           |
| 8   | Pickup Truck                                   | 1        | EA                | \$ 38,080    | \$ 38,080           |
| 9   |  |          |                   |              |                     |
| <b>Item Subtotal Construction Costs (Year )</b> |  |          |                   |              | \$ 2,825,040        |
| <b>DIRECT: CONSTRUCTION COST MARK-UPS</b>       |  |          |                   |              |                     |
|   | General Conditions                             | 10%      |                   | 1.1          | included            |
|   | Mobilization/Demobilization                    | 10%      |                   | 1.1          | included            |
|   | Overhead & Profit (OHP)                        | 10%      |                   | 1.1          | included            |
|   | Insurance                                      | 1.5%     |                   | 1.015        | included            |
|   | Bonding  | 1.0%     |                   | 1.01         | included            |
|   | Escalation Multiplier from ENR-CCI             | 0%       |                   | 1.0000       | \$ -                |
| <b>Item Subtotal Construction Costs (Year )</b> |  |          |                   |              | \$ 2,825,040        |
| <b>Direct: Subtotal Construction Costs</b>      |  |          |                   |              | <b>\$ 2,825,000</b> |

|                  |                      |
|------------------|----------------------|
| <b>Base Year</b> | <b>Estimate Year</b> |
| 2020             | 2020                 |

| Estimate - AACEI Class 5                              |  |          |       |                   |               |
|---|--|----------|-------|-------------------|---------------|
| <b>Project Name:</b>                                  | KC Class A Biosolids Tech Evaluation                             |          |       | <b>Date:</b>      | 12/30/2019    |
| <b>Location:</b>                                      | King County - South End, Site To be Determined                   |          |       | <b>Estimator:</b> | Trung Le      |
| <b>Description:</b>                                   | <b>Soil Blending Facility (Adjacent to Composting)</b>           |          |       | <b>Version:</b>   | Revision 01   |
| <b>DIRECT: SUBTOTAL CONSTRUCTION COSTS</b>            |  |          |       |                   |               |
| Item No.  | Item Description   | Quantity | Units | Unit Cost         | Item Cost     |
| 1   | Process Building (Prefab Building)                               | 22,400   | SF    | 157               | \$ 3,516,800  |
| 2   | Feedstock Storage (Tensile Membrane)                             | 24,600   | SF    | 20                | \$ 492,000    |
| 3   | Finished Product Storage (Tensile Membrane)                      | 15,000   | SF    | 20                | \$ 300,000    |
| 4   | Misc Buildings   | 15,000   | SF    | 75                | \$ 1,125,000  |
| 5   | Office/Administration Building                                   | 5,000    | SF    | 75                | \$ 375,000    |
|   | Admin Parking, Roads, Truck Access, Maintenance Yard,            |          |       |                   |               |
| 6   | Screening, Finished Product Storage (Uncovered)                  | 150,000  | SF    | 8                 | \$ 1,200,000  |
| 7   | Ponds and Collection System                                      | 60,000   | SF    | 22                | \$ 1,300,000  |
| 8   | Equipment Purchases  | 1        | LS    | 2,200,000         | \$ 2,200,000  |
| 9   | Install Equipment Purchases                                      | 1        | LS    | 1,510,000         | \$ 1,510,000  |
| 10  | Site Preparation / Demolition                                    | 438,000  | SF    | 2                 | \$ 1,012,875  |
| 11  | Site Mass Grading (whole site using avg. of 2.5' of cut to fill) | 40,556   | CY    | 5                 | \$ 182,500    |
| 12  | Water / Sewer / Electrical Services to Site                      | 1        | LS    | 250,000           | \$ 250,000    |
| 13  | Site Perimeter - Chain Link Fencing                              | 4,000    | LF    | 30                | \$ 119,200    |
| 14  | Site Perimeter - New Landscape                                   | 95,000   | SF    | 8                 | \$ 798,000    |
|   | <b>Construction Cost Markup</b>                                  |          |       |                   | \$ 4,386,319  |
|   | <b>Subtotal Construction Costs</b>                               |          |       |                   | \$ 18,767,694 |
|   | Allowance for Indeterminates (Design Allowance)                  |          |       |                   | \$ 5,360,674  |
|   | Street Use Permit  |          |       |                   | \$ -          |
|   | <b>ESTIMATED PROBABLE COST OF CONSTRUCTION BID</b>               |          |       |                   | \$ 24,128,368 |
| <b>DIRECT: SUBTOTAL ADDITIONAL CONSTRUCTION COSTS</b> |  |          |       |                   |               |
|   | Mitigation Construction Contracts                                |          |       |                   | \$ -          |
|   | Construction Change Order Allowance                              |          |       |                   | \$ 2,680,337  |
|   | Material Pricing Uncertainty Allowance                           |          |       |                   | \$ -          |
|   | <b>Subtotal Primary Construction Amount</b>                      |          |       |                   | \$ 26,808,705 |
|   | Construction Sales Tax   |          |       |                   | \$ 2,707,679  |
|   | Owner Furnished Equipment  |          |       |                   | \$ 2,675,000  |
|   | Outside Agency Construction                                      |          |       |                   | \$ -          |
|   | <b>Subtotal KC Contribution to Construction</b>                  |          |       |                   | \$ 32,191,384 |
| <b>DIRECT: SUBTOTAL OTHER CAPITAL CHARGES</b>         |  |          |       |                   |               |
|   | KC/WTD Direct Implementation                                     |          |       |                   | \$ -          |
|   | Misc. Capital Costs  |          |       |                   | \$ 58,967     |
|   | <b>TOTAL DIRECT CONSTRUCTION COSTS</b>                           |          |       |                   | \$ 32,250,000 |
| <b>INDIRECT: NON-CONSTRUCTION COSTS</b>               |  |          |       |                   |               |
|   | Design and Construction Consulting                               |          |       |                   | \$ 7,718,967  |
|   | Other Consulting Services  |          |       |                   | \$ -          |
|   | Permitting & Other Agency Support                                |          |       |                   | \$ 147,419    |
|   | Right-of-Way   |          |       |                   | \$ -          |
|   | Misc. Service & Materials  |          |       |                   | \$ 530,707    |
|   | Non-WTD Support  |          |       |                   | \$ 250,611    |
|   | WTD Staff Labor  |          |       |                   | \$ 3,602,776  |
|   | <b>Subtotal Non-Construction Costs</b>                           |          |       |                   | \$ 12,250,480 |
|   | Project Contingency  |          |       |                   | \$ 13,431,302 |
|   | Initiatives  |          |       |                   | \$ 530,272    |
|   | <b>TOTAL INDIRECT NON-CONSTRUCTION COSTS</b>                     |          |       |                   | \$ 26,212,053 |
|   | <b>TOTAL PROJECT COST</b>  |          |       |                   | \$ 58,462,405 |

|                  |                      |
|------------------|----------------------|
| <b>Base Year</b> | <b>Estimate Year</b> |
| 2020             | 2020                 |

| Estimate - AACEI Class 5   |   |                             |           |                     |                      |
|--|---|-----------------------------|-----------|---------------------|----------------------|
| <b>Project Name:</b> KC Class A Biosolids Tech Evaluation                  |   | <b>Date:</b> 12/30/2019     |           |                     |                      |
| <b>Location:</b> King County - South End, Site To be Determined            |   | <b>Estimator:</b> Trung Le  |           |                     |                      |
| <b>Description:</b> <b>Soil Blending Facility (Adjacent to Composting)</b> |   | <b>Version:</b> Revision 01 |           |                     |                      |
| CONSTRUCTION COSTS   |   |                             |           |                     |                      |
| Item No.   | Item Description  | Quantity                    | Units     | Unit Cost           | Item Cost            |
| 1  | <b>Process Building (Prefab Building)</b>                               | <b>22,400</b>               | <b>SF</b> | <b>\$ 157</b>       | <b>\$ 3,516,800</b>  |
| 2  | Primary Mixing Area   | 20,000                      | SF        | \$ 157              | \$ 3,140,000         |
| 3  | Feedstock Day Storage   | 2,400                       | SF        | \$ 157              | \$ 376,800           |
| 4  | <b>Feedstock Storage (Tensile Membrane)</b>                             | <b>24,600</b>               | <b>SF</b> | <b>\$ 20</b>        | <b>\$ 492,000</b>    |
| 5  | Feedstock Storage (Sawdust)   | 15,000                      | SF        | \$ 20               | \$ 300,000           |
| 6  | Feedstock Storage (Biosolids and Fine Sand)                             | 9,600                       | SF        | \$ 20               | \$ 192,000           |
| 7  | <b>Finished Product Storage (Tensile Membrane)</b>                      | <b>15,000</b>               | <b>SF</b> | <b>\$ 20</b>        | <b>\$ 300,000</b>    |
| 8  | <b>Misc Buildings</b>   | <b>15,000</b>               | <b>SF</b> | <b>\$ 75</b>        | <b>\$ 1,125,000</b>  |
| 9  | Maintenance Building  | 5,000                       | SF        | \$ 75               | \$ 375,000           |
| 10   | Bagging Building  | 10,000                      | SF        | \$ 75               | \$ 750,000           |
| 11   | <b>Office/Administration Building</b>                                   | <b>5,000</b>                | <b>SF</b> | <b>\$ 75</b>        | <b>\$ 375,000</b>    |
| Admin Parking, Roads, Truck Access, Maintenance Yard, Screening,           |   |                             |           |                     |                      |
| 12   | <b>Finished Product Storage (Uncovered)</b>                             | <b>150,000</b>              | <b>SF</b> | <b>\$ 8</b>         | <b>\$ 1,200,000</b>  |
| 13   | Admin Parking   | 2,500                       | SF        | \$ 8                | \$ 20,000            |
| 14   | Roads   | 50,000                      | SF        | \$ 8                | \$ 400,000           |
| 15   | Truck Access  | 25,000                      | SF        | \$ 8                | \$ 200,000           |
| 16   | Maintenance Yard  | 5,000                       | SF        | \$ 8                | \$ 40,000            |
| 17   | Screening Area  | 7,500                       | SF        | \$ 8                | \$ 60,000            |
| 18   | Finished Product Storage (Uncovered)                                    | 60,000                      | SF        | \$ 8                | \$ 480,000           |
| 19   | <b>Ponds and Collection System</b>                                      | <b>60,000</b>               | <b>SF</b> | <b>\$ 22</b>        | <b>\$ 1,300,000</b>  |
| 20   | Contact Water Pond and Collection System                                | 20,000                      | SF        | \$ 25               | \$ 500,000           |
| 21   | Stormwater Pond   | 40,000                      | SF        | \$ 20               | \$ 800,000           |
| 22   | <b>Equipment Purchases</b>  | <b>1</b>                    | <b>LS</b> | <b>\$ 2,200,000</b> | <b>\$ 2,200,000</b>  |
| 23   | Wood Grinder (mid-large Horizontal)                                     | 1                           | EA        | \$ 500,000          | \$ 500,000           |
| 24   | Mixer System (Horizontal Rotomix 1220-20, Stationary)                   | 2                           | EA        | \$ 350,000          | \$ 700,000           |
| 25   | Screen (MultiStar L3 Type)  | 1                           | EA        | \$ 550,000          | \$ 550,000           |
| 26   | Bagging Equipment (RotoChopper Go-Bagger 250)                           | 1                           | EA        | \$ 60,000           | \$ 60,000            |
| 27   | Radial Stacking Conveyors   | 2                           | EA        | \$ 195,000          | \$ 390,000           |
| 28   | <b>Install Equipment Purchases</b>                                      | <b>1</b>                    | <b>LS</b> | <b>\$ 1,510,000</b> | <b>\$ 1,510,000</b>  |
| 29   | Install Mixer System (Rotomix 1220-20, Stationary)                      | 2                           | EA        | \$ 500,000          | \$ 1,000,000         |
| 30   | Install Bagging Equipment (RotoChopper Go-Bagger 250)                   | 1                           | EA        | \$ 120,000          | \$ 120,000           |
| 31   | Install Radial Stacking Conveyors                                       | 2                           | EA        | \$ 195,000          | \$ 390,000           |
| 32   | <b>Site Preparation / Demolition</b>                                    | <b>438,000</b>              | <b>SF</b> | <b>\$ 2.31</b>      | <b>\$ 1,012,875</b>  |
| 33   | Demo Existing Building (1/4 of site size)                               | 1,642,500                   | SF        | \$ 0.50             | \$ 821,250           |
| 34   | Demo Existing Hard Surfaces (1/2 of site size)                          | 219,000                     | SF        | \$ 0.75             | \$ 164,250           |
| 35   | Demo Existing Landscape/Trees (1/4 of site size)                        | 109,500                     | SF        | \$ 0.25             | \$ 27,375            |
| 36   | <b>Site Mass Grading (whole site using avg. of 2.5' of cut to fill)</b> | <b>40,556</b>               | <b>CY</b> | <b>\$ 4.5</b>       | <b>\$ 182,500</b>    |
| 37   | <b>Water / Sewer / Electrical Services to Site</b>                      | <b>1</b>                    | <b>LS</b> | <b>\$ 250,000</b>   | <b>\$ 250,000</b>    |
| 38   | <b>Site Perimeter - Chain Link Fencing</b>                              | <b>4,000</b>                | <b>LF</b> | <b>\$ 30</b>        | <b>\$ 119,200</b>    |
| 39   | <b>Site Perimeter - New Landscape</b>                                   | <b>95,000</b>               | <b>SF</b> | <b>\$ 8</b>         | <b>\$ 798,000</b>    |
| <b>Item Subtotal Construction Costs (Year 2020)</b>                        |   |                             |           |                     | <b>\$ 14,381,375</b> |
| DIRECT: CONSTRUCTION COST MARK-UPS   |   |                             |           |                     |                      |
| General Conditions   |   | 10%                         |           | 1.1                 | \$ 1,438,137.50      |
| Mobilization/Demobilization  |   | 10%                         |           | 1.1                 | \$ 1,438,137.50      |
| Overhead & Profit (OHP)  |   | 8%                          |           | 1.08                | \$ 1,150,510.00      |
| Insurance  |   | 1.5%                        |           | 1.015               | \$ 215,720.63        |
| Bonding  |   | 1.0%                        |           | 1.01                | \$ 143,813.75        |
| Escalation Multiplier from ENR-CCI   |   | 0%                          |           | 1.0000              | \$ -                 |
| <b>Item Subtotal Construction Costs (Year 2020)</b>                        |   |                             |           |                     | <b>\$ 18,767,694</b> |
| <b>Direct: Subtotal Construction Costs</b>                                 |   |                             |           |                     | <b>\$ 18,768,000</b> |

| Estimate - AACEI Class 5                       |  |          |       |                   |                     |
|--|--|----------|-------|-------------------|---------------------|
| <b>Project Name:</b>                           | KC Class A Biosolids Tech Evaluation                   |          |       | <b>Date:</b>      | 12/30/2019          |
| <b>Location:</b>                               | King County - South End, Site To be Determined         |          |       | <b>Estimator:</b> | Trung Le            |
| <b>Description:</b>                            | <b>Soil Blending Facility (Adjacent to Composting)</b> |          |       | <b>Version:</b>   | Revision 01         |
| CONSTRUCTION COSTS                             |  |          |       |                   |                     |
| Item No.                                       | Item Description                                       | Quantity | Units | Unit Cost         | Item Cost           |
| 1  | <b>Equipment Purchases (ECS)</b>                       | 1        | LS    | \$ 2,675,040      | \$ 2,675,040        |
| 2  | Large Front End Loader (Cat 980, Type)                 | 3        | EA    | \$ 550,000        | \$ 1,650,000        |
| 3  | Small Front End Loader (Cat 950, Type)                 | 1        | EA    | \$ 300,000        | \$ 300,000          |
| 4  | Compost Turner (X67 Type)                              | 0        | EA    | \$ 600,000        | \$ -                |
| 5  | Forklift   | 1        | EA    | \$ 50,000         | \$ 50,000           |
| 6  | Repair Shop Tools                                      | 1        | LS    | \$ 200,000        | \$ 200,000          |
| 7  | Sport Utility Vehicle                                  | 1        | EA    | \$ 36,960         | \$ 36,960           |
| 8  | Pickup Truck   | 1        | EA    | \$ 38,080         | \$ 38,080           |
| 9  | Articulating Hauler Truck                              | 1        | EA    | \$ 400,000        | \$ 400,000          |
| 10   |  |          |       |                   |                     |
| <b>Item Subtotal Construction Costs (Year)</b> |  |          |       |                   | \$ 2,675,040        |
| DIRECT: CONSTRUCTION COST MARK-UPS             |  |          |       |                   |                     |
|  | General Conditions                                     | 10%      |       | 1.1               | included            |
|  | Mobilization/Demobilization                            | 10%      |       | 1.1               | included            |
|  | Overhead & Profit (OHP)                                | 10%      |       | 1.1               | included            |
|  | Insurance  | 1.5%     |       | 1.015             | included            |
|  | Bonding  | 1.0%     |       | 1.01              | included            |
|  | Escalation Multiplier from ENR-CCI                     | 0%       |       | 1.0000            | \$ -                |
| <b>Item Subtotal Construction Costs (Year)</b> |  |          |       |                   | \$ 2,675,040        |
| <b>Direct: Subtotal Construction Costs</b>     |  |          |       |                   | <b>\$ 2,675,000</b> |



|                  |                      |
|------------------|----------------------|
| <b>Base Year</b> | <b>Estimate Year</b> |
| 2020             | 2020                 |

| Estimate - AACEI Class 5                           |   |          |       |                   |                       |
|--|---|----------|-------|-------------------|-----------------------|
| <b>Project Name:</b>                               | KC Class A Biosolids Tech Evaluation                      |          |       | <b>Date:</b>      | 12/30/2019            |
| <b>Location:</b>                                   | King County - South End, Site To be Determined            |          |       | <b>Estimator:</b> | Trung Le              |
| <b>Description:</b>                                | Thermal Drying Pyrolysis Off-site Facility                |          |       | <b>Version:</b>   | Revision 01           |
| DIRECT: SUBTOTAL CONSTRUCTION COSTS                |   |          |       |                   |                       |
| Item No.   | Item Description  | Quantity | Units | Unit Cost         | Item Cost             |
| 1  | Office/Administration Building                            | 5000     | SF    | \$ 150            | \$ 750,000            |
| 2  | Admin Parking, Roads, Truck Access                        | 50000    | SF    | \$ 8              | \$ 400,000            |
| 3  | Process/Maintenance Building                              | 175000   | SF    | \$ 218            | \$ 38,155,000         |
| 4  | Equipment Purchases                                       | 1        | LS    | \$ 94,828,600     | \$ 94,828,600         |
| 5  | Install Equipment Purchases                               | 1        | LS    | \$ 51,783,950     | \$ 51,783,950         |
| 6  | Site Preparation / Demolition                             | 270000   | SF    | \$ 2              | \$ 624,375            |
| 7  | Water / Sewer / Natural Gas / Electrical Services to Site | 1        | LS    | \$ 1,000,000      | \$ 1,000,000          |
| 8  | Site Perimeter - Chain Link Fencing                       | 2000     | LF    | \$ 30             | \$ 60,000             |
| 9  | Site Perimeter - New Landscape                            | 2000     | SF    | \$ 10             | \$ 20,000             |
| <b>Construction Cost Markup</b>                    |   |          |       |                   | \$ 57,102,687         |
| <b>Subtotal Construction Costs</b>                 |   |          |       |                   | <b>\$ 244,724,612</b> |
| Allowance for Indeterminates (Design Allowance)    |   |          |       |                   | \$ 61,181,153         |
| Street Use Permit                                  |   |          |       |                   | \$ -                  |
| <b>ESTIMATED PROBABLE COST OF CONSTRUCTION BID</b> |   |          |       |                   | <b>\$ 305,905,765</b> |
| DIRECT: SUBTOTAL ADDITIONAL CONSTRUCTION COSTS     |   |          |       |                   |                       |
| Mitigation Construction Contracts                  |   |          |       |                   | \$ -                  |
| Construction Change Order Allowance                |   |          |       |                   | \$ 30,590,577         |
| Material Pricing Uncertainty Allowance             |   |          |       |                   | \$ -                  |
| <b>Subtotal Primary Construction Amount</b>        |   |          |       |                   | <b>\$ 336,496,342</b> |
| Construction Sales Tax                             |   |          |       |                   | \$ 33,986,131         |
| Owner Furnished Equipment                          |   |          |       |                   | \$ -                  |
| Outside Agency Construction                        |   |          |       |                   | \$ -                  |
| <b>Subtotal KC Contribution to Construction</b>    |   |          |       |                   | <b>\$ 370,482,472</b> |
| DIRECT: SUBTOTAL OTHER CAPITAL CHARGES             |   |          |       |                   |                       |
| KC/WTD Direct Implementation                       |   |          |       |                   | \$ -                  |
| Misc. Capital Costs                                |   |          |       |                   | \$ 672,993            |
| <b>TOTAL DIRECT CONSTRUCTION COSTS</b>             |   |          |       |                   | <b>\$ 371,155,000</b> |
| INDIRECT: NON-CONSTRUCTION COSTS                   |   |          |       |                   |                       |
| Design and Construction Consulting                 |   |          |       |                   | \$ 57,089,958         |
| Other Consulting Services                          |   |          |       |                   | \$ -                  |
| Permitting & Other Agency Support                  |   |          |       |                   | \$ 1,682,482          |
| Right-of-Way                                       |   |          |       |                   | \$ -                  |
| Misc. Service & Materials                          |   |          |       |                   | \$ 6,056,934          |
| Non-WTD Support                                    |   |          |       |                   | \$ 2,860,219          |
| WTD Staff Labor                                    |   |          |       |                   | \$ 31,528,089         |
| <b>Subtotal Non-Construction Costs</b>             |   |          |       |                   | <b>\$ 99,217,682</b>  |
| Project Contingency                                |   |          |       |                   | \$ 141,111,944        |
| Initiatives  |   |          |       |                   | \$ 5,788,093          |
| <b>TOTAL INDIRECT NON-CONSTRUCTION COSTS</b>       |   |          |       |                   | <b>\$ 246,117,719</b> |
| <b>TOTAL PROJECT COST</b>                          |   |          |       |                   | <b>\$ 617,273,184</b> |

| Base Year | Estimate Year |
|-----------|---------------|
| 2020      | 2020          |

| Estimate - AACEI Class 5                                 |  |            |       |               |                       |
|--|--|------------|-------|---------------|-----------------------|
| Project Name: KC Class A Biosolids Tech Evaluation       |  | Date:      |       | 12/30/2019    |                       |
| Location: King County - South End, Site To be Determined |  | Estimator: |       | Trung Le      |                       |
| Description: Thermal Drying Pyrolysis Off-site Facility  |  | Version:   |       | Revision 01   |                       |
| CONSTRUCTION COSTS                                       |  |            |       |               |                       |
| Item No.   | Item Description   | Quantity   | Units | Unit Cost     | Item Cost             |
| 1  | Office/Administration Building   | 5,000      | SF    | \$ 150        | \$ 750,000            |
| 2  | Admin Parking, Roads, Truck Access                                     | 50,000     | SF    | \$ 8          | \$ 400,000            |
| 3  | Admin Parking  | 2,500      | SF    | \$ 8          | \$ 20,000             |
| 4  | Roads (Asphalt)  | 25,000     | SF    | \$ 12         | \$ 300,000            |
| 5  | Truck Access   | 10,000     | SF    | \$ 8          | \$ 80,000             |
| 6  | Process/Maintenance Building   | 175,000    | SF    | \$ 218.03     | \$ 38,155,000         |
| 7  | Pre-Fabricated Building - Process, Maintenance, Electrical, Mechanical | 175,000    | SF    | \$ 175        | \$ 30,625,000         |
| 8  | Concrete Slab  | 161,200    | SF    | \$ 25         | \$ 4,030,000          |
| 9  | Additional Electrical  | 175,000    | SF    | \$ 20         | \$ 3,500,000          |
| 10   | Equipment Purchases  | 1          | LS    | \$ 94,828,600 | \$ 94,828,600         |
| 11   | DLT 1120 Belt Dryers   | 12         | EA    | \$ 2,723,217  | \$ 32,678,600         |
| 12   | BFT P-THREE Pyrolysis Unit   | 24         | EA    | \$ 2,075,000  | \$ 49,800,000         |
| 13   | Conveyance System, Sludge Pumps, etc                                   | 1          | EA    | \$ 750,000    | \$ 750,000            |
| 14   | Hot Water Boilers  | 2          | EA    | \$ 500,000    | \$ 1,000,000          |
| 15   | Storage Hoppers  | 5          | EA    | \$ 500,000    | \$ 2,500,000          |
| 16   | Odor Control   | 1          | LS    | \$ 7,500,000  | \$ 7,500,000          |
| 17   | Storage Containers   | 2          | EA    | \$ 300,000    | \$ 600,000            |
| 18   | Install Equipment Purchases  | 1          | LS    | \$ 51,783,950 | \$ 51,783,950         |
| 19   | Install DLT 1120 Belt Dryer  | 12         | EA    | \$ 2,042,413  | \$ 24,508,950         |
| 20   | Install BFT P-THREE Pyrolysis Unit                                     | 24         | EA    | \$ 1,037,500  | \$ 24,900,000         |
| 21   | Install Hot Water Boiler   | 2          | EA    | \$ 250,000    | \$ 500,000            |
| 22   | Install Conveyance System and Hoppers                                  | 5          | EA    | \$ 375,000    | \$ 1,875,000          |
| 23   | Site Preparation / Demolition  | 270,000    | SF    | \$ 2.31       | \$ 624,375            |
| 24   | Demo Existing Building   | 1,012,500  | CF    | \$ 0.50       | \$ 506,250            |
| 25   | Demo Existing Hard Surfaces  | 135,000    | SF    | \$ 0.75       | \$ 101,250            |
| 26   | Demo Existing Landscape/Trees  | 67,500     | SF    | \$ 0.25       | \$ 16,875             |
| 27   | Water / Sewer / Natural Gas / Electrical Services to Site              | 1          | LS    | \$ 1,000,000  | \$ 1,000,000          |
| 28   | Site Perimeter - Chain Link Fencing                                    | 2,000      | LF    | \$ 30.00      | \$ 60,000             |
| 29   | Site Perimeter - New Landscape   | 2,000      | SF    | \$ 10.00      | \$ 20,000             |
| <b>Item Subtotal Construction Costs (Year 2020)</b>      |  |            |       |               | <b>\$ 187,221,925</b> |
| <b>DIRECT: CONSTRUCTION COST MARK-UPS</b>                |  |            |       |               |                       |
|  | General Conditions   | 10%        |       | 1.1           | \$ 18,722,192.50      |
|  | Mobilization/Demobilization  | 10%        |       | 1.1           | \$ 18,722,192.50      |
|  | Overhead & Profit (OHP)  | 8%         |       | 1.08          | \$ 14,977,754.00      |
|  | Insurance  | 1.5%       |       | 1.015         | \$ 2,808,328.88       |
|  | Bonding  | 1.0%       |       | 1.01          | \$ 1,872,219.25       |
|  | Escalation Multiplier from ENR-CCI                                     | 0%         |       | 1.0000        | \$ -                  |
| <b>Item Subtotal Construction Costs (Year 2020)</b>      |  |            |       |               | <b>\$ 244,324,612</b> |
| <b>Direct: Subtotal Construction Costs</b>               |  |            |       |               | <b>\$ 244,325,000</b> |



# King County

Department of Natural Resources and Parks  
**Wastewater Treatment Division**

## Project Planning and Delivery Section

### BASIS OF ESTIMATE

---

|                          |  |
|--------------------------|--|
| Project Name             | <b>King County Class A Biosolids Technology Evaluation</b> |
| Project Number           | 151084   |
| Date Prepared            | 01/24/2020   |
| Requested by             | Catherine Gowan, King County WTD                           |
| Prepared by              | Trung Le, Brown and Caldwell                               |
| Estimate Classification  | Class 5 AACE International                                 |
| Estimate Purpose         | Formulation Project  |
| Estimate ID (Version)    | 01   |
| Project Manager          | Catherine Gowan  |
| Project Control Engineer |  |
| Cc or Distribution List  | John Conway, Ashley Mihle                                  |

*Note that the accuracy of the associated cost estimate is dependent upon the various underlying assumptions, inclusions, and exclusions described herein. Actual project costs may differ and can be significantly affected by factors such as changes in the external environment, the manner in which the project is executed and controlled, and other factors that may impact the estimate basis or otherwise affect the project. Estimate accuracy ranges are only assessments based upon the cost estimating methods and data employed in preparing the estimate and are not a guarantee of actual project costs.*

**BASIS OF ESTIMATE**

|                 |                      |       |            |
|-----------------|----------------------|-------|------------|
| Project Name    | <b>Project Title</b> |       |            |
| Project Number: | 151084.452           | Date: | 01/24/2020 |

**1.0 Purpose**

The purpose of this project was to conduct a Class A biosolids technology evaluation for King County (County). This project was developed to assist the County in preparing their response to King County Council Proviso 2019-0148.P3 Version 2. The proviso calls for the identification of Class A alternatives to the current Class B biosolids application in forest and farm environments. The County is interested in diversifying the biosolids products to increase resiliency. The evaluation built upon the Solids Processing Technology Evaluation (Task 450) that was performed as part of the King County Treatment Plant Flows and Loads Study. The previous evaluation identified and screened solids treatment technologies for each of the County's three regional treatment plants. Other earlier studies conducted for the County on Class A biosolids treatment alternatives were also used as background materials for the study.

The TM documents the following subtasks:

- Class A technology screening
- Overview descriptions of the short-listed technologies, including a more detailed description of the gasification/pyrolysis technology
- Development of biosolids treatment and disposal/reuse scenarios
- Conceptual modeling of each scenario to evaluate solids production, energy usage, and greenhouse gas (GHG) emissions.
- Development of conceptual capital and operating and maintenance (O&M) cost estimates
- Evaluation of the scenarios based on triple bottom line (TBL) criteria.

Class 5 probable cost of construction estimates for the different scenarios were developed and used for the economic analysis and TBL evaluation. The expected accuracy range was +100%/-50% as typical with Class 5 estimates.

**2.0 Project Scope Definition**

The construction estimates were based on the four scenarios below. These scenarios were developed from the short-listed technologies, and each scenario provides biosolids management for all biosolids produced by King County wastewater treatment plants. They are as follows:

- **Scenario 1: Base-case** - Existing MAD with 100 percent Class B land application to western and eastern Washington
- **Scenario 2: Enhanced Class A** - Existing mesophilic digestion at Brightwater with Class B biosolids hauled to an off-site Class A composting facility and local sales; Cambi at South Plant with Class A land application in western and eastern Washington (40 percent/60 percent); and TAD with batch tanks at West Point and off-site soil blending with local sales
- **Scenario 3: Pyrolysis** - Existing mesophilic digestion at all three plants with dewatered cake hauled to off-site thermal drying and pyrolysis treatment. Biochar byproduct contracted to Bioforcetech under a public-private partnership.
- **Scenario 4: Optimized Class A** - Existing mesophilic digestion at Brightwater with Class B biosolids hauled to an off-site Class A composting facility and local sales; TAD with batch tanks at

**BASIS OF ESTIMATE**

|                 |                      |       |            |
|-----------------|----------------------|-------|------------|
| Project Name    | <b>Project Title</b> |       |            |
| Project Number: | 151084.452           | Date: | 01/24/2020 |

South Plant with Class A land application in western and eastern Washington (40 percent/60 percent); and TAD with batch tanks at West Point and off-site soil blending with local sales

The sizing for each of the scenarios was based on flows and loads that were projected to a 2050 design year. Raw influent flows and loadings for each of the three plants were provided by the County as part of flows and loads study to evaluate treatment plant capacity limitations. A plant-wide solids mass balance model calibrated during that study was used to calculate digester feed solids loading rates from the 2050 raw influent flows and loadings. **Table 1** presents a summary of the construction.

**Table 1 – Summary of Scenario Construction**

| Scenarios | Facility      | Construction  |
|-----------|---------------|---|
| S1        | West Point    | 2 New Meso Digester   |
|           | South Plant   | 1 New Meso Digester   |
|           | Brightwater   | 1 New Meso Digester   |
| S2        | West Point    | TAD Conversion (heating upgrades, mixing, cleaning)   |
|           | Soil Blending | New Off-Site Facility (buildings, site prep, machinery, utilities, etc)                                 |
|           | South Plant   | THP-MAD System (pre-dewatering, screens, steam boilers, etc)  |
|           | Brightwater   | 1 New Meso Digester   |
|           | Composting    | New Off-Site Facility (buildings, site prep, machinery, utilities, etc)                                 |
| S3        | West Point    | 2 New Meso Digester   |
|           | South Plant   | 1 New Meso Digester   |
|           | Brightwater   | 1 New Meso Digester   |
|           | Pyrolysis     | New Off-Site Facility (buildings, site prep, thermal dryers, pyrolysis equipment, odor, utilities, etc) |
| S4        | West Point    | TAD Conversion (heating upgrades, mixing, cleaning)   |
|           | Soil Blending | New Off-site Facility (buildings, site prep, machinery, utilities, etc)                                 |
|           | South Plant   | TAD Conversion (heating upgrades, mixing, cleaning)   |
|           | Brightwater   | 1 New Meso Digester   |
|           | Composting    | New Off-site Facility (buildings, site prep, machinery, utilities, etc)                                 |

**Scenario 1**

New mesophilic digesters will be required at each of the wastewater treatment plants as reflected in **Table 1**. The cost for these digesters were unit prices sourced from an average of other projects in the region. This estimate was inclusive and assumed similar sizing to existing digesters, materials, digestion mixing, floating/fixed covers, and other ancillary components.

**Scenario 2**

**BASIS OF ESTIMATE**

|                 |                      |       |            |
|-----------------|----------------------|-------|------------|
| Project Name    | <b>Project Title</b> |       |            |
| Project Number: | 151084.452           | Date: | 01/24/2020 |

West Point's conversion to a TAD system would require no additional digesters. However, the existing floating covers and mixing system would need to be upgraded. An additional two boilers would be installed to supply the heat required to maintain thermophilic digestion. A heat pump would be used to cool and recover the heat to preheating of the sludge. The cost estimates included minor repairs and cleaning of the digesters.

South Plant would utilize Cambi's thermal hydrolysis process. This system requires additional ancillary equipment that includes pre-dewatering, screening, blend tanks, and steam boilers. These systems along with the THP process would be housed in a new multi-floor building.

The soil blending facility was sized based on Tacoma's Tagro blended product that is comprised of 40:40:20 biosolids to sawdust to sand. The soil blending would occur in a prefabricated semi-closed building. Feedstocks and a portion of the blended product would be stored under a membrane canopy building. Other facilities include a bagging building. Maintenance and admin buildings would be shared with the adjacent composting facility. Major equipment includes batch auger mixers, trommel screen, front end loaders, hauling trucks, conveyors, a grinder, and bagging equipment.

Brightwater would require the additional construction of a fixed cover mesophilic digester.

The composting facility was modeled based on the aerated static pile system (Option 2) in the Compost Facility Basis of Estimation document (under King County Project 1132733). This system uses a perforated aeration pipe network floor for the active compost phase. The composting and curing process occurs under a roof. Feedstocks are also covered. Additional facilities include maintenance and admin buildings, and a bagging facility. Major equipment includes batch auger mixers, trommel screen, front end loaders, hauling trucks, conveyors, a grinder, and bagging equipment.

**Scenario 3**

Scenario 3 requires the same construction requirements as Scenario 1 but with the addition of an off-site thermal drying and pyrolysis facility. Major equipment includes thermal dryers, pyrolysis units, and odor control. The facility will be housed in an enclosed prefabricated metal facility. Construction costs were inclusive of utilities and other ancillary components.

**Scenario 4**

This scenario has the same construction requirements as Scenario 2 except for South Plant which would use TAD instead of THP-MAD. This would significantly reduce the construction requirement and only require the conversion of the MAD system to TAD. This includes replacing existing floating covers with fixed covers and upgrading the mixing system. An additional two boilers would be installed to supply the heat required to maintain thermophilic digestion. A heat pump would be used to cool and recover the heat to preheating of the sludge. The cost estimates included minor repairs and cleaning of the digesters.

**3.0 Design Basis**

The design basis of the scenarios was developed from KC Class A Biosolids Technology Evaluation Technical Memorandum. Additional information can be found in this technical memorandum.

## BASIS OF ESTIMATE

|                 |                      |       |            |
|-----------------|----------------------|-------|------------|
| Project Name    | <b>Project Title</b> |       |            |
| Project Number: | 151084.452           | Date: | 01/24/2020 |

### 4.0 Planning Basis

This project is a high-level alternative analysis of feasible Class A biosolids management programs. A more thorough alternatives analysis would need to be completed at a later date to develop further scope parameters, cost and etc.

### 5.0 Cost Basis

The cost estimate has been prepared in accordance with AACE International as a Class 5 estimation for projects with a maturity level of 0% to 2%. The cost estimate was intended for concept screening and uses costing methodologies such as capacity factored, parametric models, judgment, or analogy. The expected high side accuracy range is +30% to +100% and the low side accuracy is -20% to -50%. For this study, it is expected that the range of accuracy is within -50% to +100% of the estimate. Table 2 represents the total project capital cost for each of the scenarios and is inclusive of all KC WTD allowances.

**Table 2 – Total Project Capital Cost**

| Parameters and Scenarios             | Low Range<br>(AACE: -20% to -50%) | Total Project Capital Cost | High Range<br>(AACE: +30% to +100%) |
|--------------------------------------|-----------------------------------|----------------------------|-------------------------------------|
| Accuracy Range                       | -50%                              | -                          | +100%                               |
| <b>Scenario 1: Base-case</b>         | \$132,000,000                     | <b>\$264,000,000</b>       | \$528,00,000                        |
| <b>Scenario 2: Enhanced Class A</b>  | \$433,000,000                     | <b>\$867,000,000</b>       | \$1,734,000,000                     |
| <b>Scenario 3: Pyrolysis</b>         | \$441,000,000                     | <b>\$881,000,000</b>       | \$1,762,000,000                     |
| <b>Scenario 4: Optimized Class A</b> | \$231,000,000                     | <b>\$462,000,000</b>       | \$924,00,000                        |

Methods and sources used to determine construction costs are listed below:

- All construction, direct and indirect costs were estimated utilizing local unit price analysis. The unit price analyses were derived from other local projects or national projects which were adapted using ENR-CCI factors
- All costs are estimated in 2020 dollars unless stated.
- Vendor quotes were provided for thermal drying and pyrolysis equipment in scenario 3
- Costs for THP were derived from 100% design documents and estimations.

### 6.0 Allowances

The Allowance for Indeterminates (AFI) was applied to the construction cost and varied depending on the sourcing of the cost estimation. The AFI is an allowance that accounts for the cost of known but undefined requirements necessary for a complete and workable project. **Table 3** provides a summary of the AFI selected for each of the cost estimates.



**BASIS OF ESTIMATE**

|                 |                      |       |            |
|-----------------|----------------------|-------|------------|
| Project Name    | <b>Project Title</b> |       |            |
| Project Number: | 151084.452           | Date: | 01/24/2020 |

**Table 3 – Summary of Data Sourcing and Allowances for Indeterminates**

| Scenarios | Facility      | Modification  | Data Source   | AFI |
|-----------|---------------|---|---|-----|
| S1        | West Point    | 2 New Meso Digester   | Compiled Project Data (Various Years)   | 25% |
|           | South Plant   | 1 New Meso Digester   |   |     |
|           | Brightwater   | 1 New Meso Digester   |   |     |
| S2        | West Point    | TAD Conversion (heating upgrades, mixing, cleaning)                     | 100% Design (2018)  | 20% |
|           | Soil Blending | New Off-site Facility (buildings, site prep, machinery, utilities, etc) | Engineer's Estimate/ Project Data   | 25% |
|           | South Plant   | THP-MAD System (predewatering, screens, steam boilers, etc)             | 100% Design (2019 West Coast)   | 15% |
|           | Brightwater   | 1 New Meso Digester   | Compiled Project Data (Various Years)   | 25% |
|           | Composting    | New Off-site Facility (buildings, site prep, machinery, utilities, etc) | Scaled from King County Project (1132733) BOE Compost Facility, Engineer's Estimate/ Project Data | 25% |
| S3        | West Point    | 2 New Meso Digester   | Compiled Project Data (Various Years)   | 25% |
|           | South Plant   | 1 New Meso Digester   |   |     |
|           | Brightwater   | 1 New Meso Digester   |   |     |
|           | Pyrolysis     | New Off-site Facility (buildings, site prep, machinery, utilities, etc) | Vendor Quotes   | 25% |
| S4        | West Point    | TAD Conversion (heating upgrades, mixing, cleaning)                     | 100% Design (2018)  | 20% |
|           | Soil Blending | New Off-site Facility (buildings, site prep, machinery, utilities, etc) | Engineer's Estimate/ Project Data   | 25% |
|           | South Plant   | TAD Conversion (heating upgrades, mixing, cleaning)                     | 100% Design (2018)  | 20% |
|           | Brightwater   | 1 New Meso Digester   | Compiled Project Data (Various Years)   | 25% |
|           | Composting    | New Off-site Facility (buildings, site prep, machinery, utilities, etc) | Scaled from King County Project (1132733) BOE Compost Facility, Engineer's Estimate/ Project Data | 25% |

**7.0 Assumptions**

General assumptions are documented below if not already explicitly stated elsewhere in the estimate basis. Some assumptions were carried over from the BOE 20% Composting Facility estimate previously completed under Project 1132733.

**BASIS OF ESTIMATE**

|                 |                      |       |            |
|-----------------|----------------------|-------|------------|
| Project Name    | <b>Project Title</b> |       |            |
| Project Number: | 151084.452           | Date: | 01/24/2020 |

- Off-site facilities (blending, composting, and pyrolysis) are assumed to be located within King County but separate from any existing King County WTD facilities. Impacts to project cost may occur based on the selection of locations.
- Assumptions related to potential South King County site preparation will require:
  - Existing Building Demolition – assumed building covers ¼ of the site and is 15' tall.
  - One half of the existing site is covered by asphalt/concrete requiring removal of same.
  - It is assumed that ¼ of the site will be covered by vegetation/trees that will require removal.
  - Earthwork – the estimate assumes that the site will require rough grading. An assumption of a need to cut and fill the site to obtain required grades would be an average of 2.5 feet in depth across the whole site.
- The WTD Prism cost model default values were used to included costs for permitting, easements, and WTD costs.
- It is assumed that the project generally aligns with WTD's Treatment PRISM cost model.
- It is assumed that all work will be performed utilizing safe work methods at all times.
- It is assumed that work will be sequenced to minimize process, service, and community interruptions.
- Any additional work discovered during project excavation would need to be either a supplemental approval or be approved as an additional project.
- It is assumed that any community impact costs are minimal. Any substantial impacts and their subsequent costs are beyond the scope of this project.
- It is assumed that this project will be engineered to meet any normal area seismic requirements.
- It is assumed that the current site selection is only conceptual, at this time and will be further analyzed under Alternative Analysis.
- Contractor project mark-ups have been included as add-ons to the construction estimates and were left as default values.
- This estimate does not include any allowances for ESJ. It is assumed that ESJ opportunities will be explored at project initiation and that any associated costs will be budgeted for at that time.

**8.0 Exclusions**

All potential items of cost which might be associated with the project but for which no costs have been included are listed below:

- No land acquisition/purchase costs were included.
- No hazardous waste removal costs such as asbestos, lead paint, or contaminated soils were included.

**BASIS OF ESTIMATE**

|                 |                      |       |            |
|-----------------|----------------------|-------|------------|
| Project Name    | <b>Project Title</b> |       |            |
| Project Number: | 151084.452           | Date: | 01/24/2020 |

- Site specific concerns or difficulties unique to a specific site.
- Geotechnical requirements or special foundations.
- Additional work/costs related with neighborhood and homeowners association requirements.
- No estimated costs are included for any potential delays due to interferences.
- No estimated costs were included for sequencing of offline digesters.
- No costs are included for any additional scope beyond that as detailed in the current scope of work.
- No additional estimating allowances for WTD indirect costs have been included in the Total Project Cost estimate since a Routine degree of complexity rating was applied for Construction Management, Permitting & Licenses, Operations Support, Project Management, and Project Controls.
- No allowances for tariffs have been included.

**9.0 Exceptions**

---

Not Applicable.

**10.0 Risks (Threats and Opportunities)**

---

The magnitude of this evaluation has risks in costing. Siting of off-site facilities can potentially result in unknow costs for preparation, remediation, and permitting requirements.

Pyrolysis represents a new technology that has financial risks due to the uncertainty of operation and market acceptance.

**11.0 Contingency**

---

A contingency is a cost element intended to cover uncertainties and unforeseeable elements of cost within the defined project scope. Contingency covers inadequacies in project scope definition, estimating methods, and estimating data.

Contingency specifically excludes changes in project scope, and unforeseen major events such as earthquakes, prolonged labor strikes, etc.

A 30% Project Contingency was added to the base estimate of Total Project Costs (direct and indirect) in accordance with the King County WTD project delivery process. The total project cost at a 50% confidence level is typically used for funding and baselining of a project at this stage of engineering and project development.

**12.0 Management Reserve**

---

Management reserves are an owner's contingency and have not been applied per the default County Prism model.

**BASIS OF ESTIMATE**

|                 |                      |       |            |
|-----------------|----------------------|-------|------------|
| Project Name    | <b>Project Title</b> |       |            |
| Project Number: | 151084.452           | Date: | 01/24/2020 |

**13.0 Reconciliation**

---

Not Applicable.

**14.0 Benchmarking**

---

Not Applicable.

**16.0 Attachments**

---

Not Applicable.

## **Attachment D: Triple Bottom Line**

---



### TBL Evaluation

King County Class A Biosolids Technology Evaluation  
Brown and Caldwell  
1/28/2020

Scenario 1 - Base Case  
Scenario 2 - Enhanced Class A  
Scenario 3 - Pyrolysis  
Scenario 4 - Optimized Class A

| Class A Biosolids Technology Evaluation |  |                  |                |                       |                               |                        |                                | Notes  |
|---|--|------------------|----------------|-----------------------|-------------------------------|------------------------|--------------------------------|--|
| ID                                      | Evaluation Criteria                              | Weighting Factor | Possible Score | Scenario 1- Base Case | Scenario 2 - Enhanced Class A | Scenario 3 - Pyrolysis | Scenario 4 - Optimized Class A |  |
| <b>Social and Equity Category</b>       |  |                  |                |                       |                               |                        |                                | <p>S2, S3, S4 have more local noise generation due to the operation of offsite facilities. Off-site facilities assumed to be located in South Plant region (based on previous composting study) which has a high ESJ opportunity and high SVI score, impacts to these communities would be more severe.</p> <p>Compost, Soil Blending, Pyrolysis will generate some additional odor. More odor generated from soil-blending and composting. Pyrolysis has odors but a smaller footprint. Off-site facilities assumed to be located in South Plant region (based on previous composting study) which has a high ESJ opportunity and high SVI score, impacts to these communities would be more severe.</p> <p>S1 is mostly long haul trucking. S2 has more local trucking and less long haul. Limited long haul trucking in S3 but more local traffic. Off-site facilities assumed to be located in South Plant region (based on previous composting study) which has a high ESJ opportunity and high SVI score, impacts to these communities would be more severe.</p> <p>For Economic Development and Jobs: S2 and S4 would require the greatest amount of additional staff to operate and maintain facilities. S3 would require additional staff to operate offsite facility but less than S2 and S4. S1 would require the least amount of additional staff. Additionally, retail sales of compost and soil blended products would help to support the local economy via nurseries, landscapers, garden stores, and donations. Working Conditions would be the worst for S2 and S4 due to outdoor facility and odors. S3 would deal with odors and potentially hazardous environments</p> <p>Although S1 contributes the most to agriculture, it is located in Eastern Washington and used for mostly wheat, grains, and hops. S2 and S4 products will be largely sold locally for use in gardens and lawns which would likely see increase in local agriculture production. Biochar is intended for more niche applications such as cannabis production and less on agriculture. Blending into a product may make it more economic for agriculture use.</p> <p>S1 and S4 have the lowest GHG emissions and are less than 10% from each other. S2 is close to S1 and S4. S3 has significantly higher GHG emissions than any of the other scenarios Refer to Figure 4-1 in the report or Appendix B</p> <p>Energy Production is the same across the scenarios due to no changes in the gas utilization strategy. Electricity was consumed in the order from high to low S2, S3, S4, S1</p> <p>Fossil fuel usage was greatest in S3 with double the fossil fuel usage as S1 and S4. S2 is approximately 20% higher than S1. S1 and S4 are less than 5% of a difference. Refer to Appendix B</p> <p>S3 has the highest risk in not meeting 100% beneficial reuse due to the market uncertainty and putting 100% of product into one processing market/customer. There is no redundancy or flexibility through this P3. If the facility fails or BFT can't sell their product, biosolids would likely send to landfill. S3 also has a bit of uncertainty with WA DOE evaluating biosolids biochar on a case-by-case basis for beneficial reuse. S1 has the second lowest score due to limited market diversity and single product. S2 and S4 are more resilient in meeting 100% beneficial reuse goals.</p> <p>Current research suggests that biological treatment such as MAD only degrade some contaminants of emerging concern (CEC). TAD has improvements over MAD for degradation of some addition CECE. Composting and THP have been shown to decrease a larger group of CEC while Pyrolysis has been shown to significantly decrease a wide range of different types of CEC. Compost and soil blending can also decrease concentrations through dilution with clean feedstocks .</p> <p>S1 was given 4 because it still represents a high cost. S2 and S3 are almost double the cost and given a 2. S4 was given a 3 as it was 50% more of the cost. Refer to Section 5 of the report or Appendix C</p> <p>S1 has lowest capital cost. S4 is two times the capital cost of S1. S2 and S3 is 4 times the capital cost of S1. Refer to Section 5 of the report or Appendix C</p> <p>S2 and S4 have the most product and market diversity compared to S1 and S3. Less risk that comes with single market exposure. S3 has a potentially large market diversity due to uses in non traditional biosolids applications such as industrial and commercial uses but greater risk due to unproven demand for product and single entity handling the biosolids. S1 has the least amount of market diversity but already large available market for product</p> <p>S3 has the lowest process reliability given that only one pyrolysis system is in operation in the United States and few in the rest of the world. One THP-MAD facility in the United States but there are more than 30+ facilities in the world with THP-MAD from Cambi</p> <p>Constructability/footprint assessed at the treatment plant only. S4 has the least plant footprint requirement and most constructible design. S4 Less footprint than S2. S1 and S3 requires additional digesters which would consume more plant footprint. Constructability issues for additional digesters for S1 and S4.</p> <p>Off-site permitting challenging for S2, S3, and S4. S3 air permitting challenging to acquire.</p> <p>S1 and S3 do not address capacity increases at WP. S2 and S4 provides significant digestion capacity increase at WP and SP</p> <p>S1 has the lowest capital requirements and does not impact future nutrient programs. S2 has increased high capital and ammonia recycle. S3 has increased high capital requirements. S4 has increased ammonia recycle (S4) but lower capital than (S2, S3)</p> <p>Additional processes would result in greater complexity. THP-MAD in S2 and thermal drying and pyrolysis in S3 are the most complex systems. S4 has soil blending and composting process and TAD which increases system complexity compared to S1</p> |
|   | Built & Natural Environment                      |                  |                |                       |                               |                        |                                |  |
| S1                                      | Noise  | 2                | 5              | 5                     | 2                             | 3                      | 2                              |  |
| S2                                      | Odor   | 3                | 5              | 4                     | 2                             | 2                      | 2                              |  |
| S3                                      | Traffic  | 2                | 5              | 4                     | 2                             | 3                      | 2                              |  |
| S4                                      | Economic Development/Jobs                        | 5                | 5              | 3                     | 4                             | 3                      | 4                              |  |
| S5                                      | Food Systems                                     | 3                | 5              | 3                     | 4                             | 2                      | 4                              |  |
|   | <b>Subtotal</b>                                  | <b>15</b>        |                | <b>10.8</b>           | <b>9.2</b>                    | <b>7.8</b>             | <b>9.2</b>                     |  |
| <b>Environmental Category</b>           |  |                  |                |                       |                               |                        |                                |  |
|   | Sustainability                                   |                  |                |                       |                               |                        |                                |  |
| C1                                      | Greenhouse Gas Emissions                         | 10               | 5              | 5                     | 4                             | 1                      | 5                              |  |
| C2                                      | Energy Production/Usage                          | 5                | 5              | 5                     | 3                             | 2                      | 4                              |  |
| C3                                      | Fossil Fuel Use                                  | 5                | 5              | 5                     | 4                             | 2                      | 5                              |  |
| C4                                      | 100% Beneficial Reuse Regulatory Compliance/Risk | 5                | 5              | 3                     | 5                             | 2                      | 5                              |  |
| C5                                      | Flexibility to Meet Future Regulations           | 5                | 5              | 2                     | 4                             | 5                      | 3                              |  |
|   | <b>Subtotal</b>                                  | <b>30</b>        |                | <b>25</b>             | <b>24</b>                     | <b>13</b>              | <b>27</b>                      |  |
| <b>Economic Category</b>                |  |                  |                |                       |                               |                        |                                |  |
| E1                                      | Lifecycle Cost                                   | 10               | 5              | 4                     | 2                             | 2                      | 3                              |  |
| E2                                      | Total Project Capital Cost                       | 5                | 5              | 5                     | 1                             | 1                      | 3                              |  |
| E3                                      | Market Diversification/Risk                      | 10               | 5              | 2                     | 5                             | 2                      | 5                              |  |
|   | <b>Subtotal</b>                                  | <b>25</b>        |                | <b>17</b>             | <b>15</b>                     | <b>9</b>               | <b>19</b>                      |  |
| <b>Technical Category</b>               |  |                  |                |                       |                               |                        |                                |  |
| T1                                      | Process Reliability                              | 10               | 5              | 5                     | 4                             | 2                      | 5                              |  |
| T2                                      | Constructability/Footprint                       | 3                | 5              | 3                     | 4                             | 3                      | 5                              |  |
| T3                                      | Site Permitting                                  | 2                | 5              | 5                     | 3                             | 2                      | 3                              |  |
| T4                                      | Addressing Solids Handling Capacity              | 5                | 5              | 3                     | 5                             | 3                      | 5                              |  |
| T5                                      | Compatibility with Capital and Planning Projects | 5                | 5              | 4                     | 2                             | 3                      | 3                              |  |
| T6                                      | Operational Complexity                           | 5                | 5              | 5                     | 2                             | 3                      | 4                              |  |
|   | <b>Subtotal</b>                                  | <b>30</b>        |                | <b>25.8</b>           | <b>20.6</b>                   | <b>15.6</b>            | <b>26.2</b>                    |  |
|   | <b>Total</b>                                     | <b>100</b>       |                | <b>78.6</b>           | <b>68.8</b>                   | <b>45.4</b>            | <b>81.4</b>                    |  |

### **Social and Equity Category**

The social and equity criteria category factors how each scenario can increase or decrease the quality of life of King County residents, taking into account the differing baselines for the communities around South, West Point, and Brightwater Treatment Plants.

The Center for Disease Control has developed a Social Vulnerability Index (SVI) as an indicator of how resilience communities are to external stresses on human health caused by natural or human-caused disaster, or disease pandemic. The rating is from 0 to 1, with 1 being completely vulnerable and unable to handle external stresses and 0 being very resilient. SVI can be directly correlated to the community's socioeconomic, racial, and language diversity statuses. Less affluent and more diverse communities are often closer to a value of 1. Equity opportunities exist in communities with high diversity and low socioeconomic status. SVI is a tool that King County has used to identify those opportunities for improvement. The table below summarizes the SVI values for the communities around King County's treatment plants.

|                                  | West Point | South Plant | Brightwater |
|----------------------------------|------------|-------------|-------------|
| Community by Plant (Overall SVI) | 0.04       | 0.69-0.92   | 0.18        |
| Service Area Average             | 0.33       | -           | 0.33        |
| County Average SVI               | 0.36       |             |             |

Based on this information, the communities surrounding South Plant have more vulnerabilities to external stresses due to greater diversity and low socioeconomic environment. This would indicate that the impacts of projects to the community would be more severe. Therefore for this study, impacts to the community in the South Plant area was scored lower than impacts in other areas.

**Built & Natural Environment** (Ordinance Definition: Healthy built and natural environments for all people that include mixes of land use that support: jobs, housing, amenities and services; trees and forest canopy; clean air, water, soil and sediment)

**Noise (2)** – increases in noise is a generally a result of the use of heavy machinery as well as the addition of processes outside the current boundaries of the treatment plants

**Traffic (2)** – Greater volumes of biosolids will require additional trucking and hauling. These additional vehicles can impact local and regional traffic

**Odor/Air Quality (3)** – Odor, dust, fumes, and smoke can create a nuisance to surrounding community

**Economic Development/Jobs (5)** The addition of treatment processes will require an increase in staff to operate and maintain the new facilities, which will create local jobs for the community.

Additionally, consideration was given scenarios that were able to increase economic opportunities for farmers, nursery owners, contractors, or other businesses, which in turn could stimulate the local economy, and return benefits to the community through increased capital.

**Working conditions** for King County public works staff can be impacted based on indoor and outdoor facilities, system complexity, and hazardous and nuisance working conditions.

**Food Systems (3)**



- Includes information about increased or decreased opportunities for local (<100 miles) food production

### **Environmental Category**

#### ***Sustainability***

**Greenhouse Gas Emissions (10)** - King County has developed a Strategic Climate Action Plan with a goal to achieve carbon-neutral operations by 2025. Management of a biosolids program with a focus on energy recovery, low energy solutions, increase in carbon sinks, and the reduction in sources of greenhouse gas (GHG) emissions will aid King County in reaching these goals. A GHG inventory was used to track emissions from the scenarios and include fugitive emissions, carbon sequestration, fertilizer offsets, energy use, and material consumption.

**Net Energy Use/Production (5)** - The generation and use of renewable energy is one of the major goals of King County's Energy Plan. With a target to reduce normalized energy consumption by at least 10 percent by 2025 and energy neutrality in operations and purchasing by the same deadline, renewable energy production and the reduction in external power consumption is vital to meeting those targets.

**Fossil Fuel Use (5)** - The non-renewable and limited supply of fossil fuels in the world make its use unsustainable. To conserve energy for future generations, fossil fuel usage will be considered for each scenario. Increased fossil fuel usage will generate a lower rating for the scenario.

#### **100% Beneficial Reuse Regulatory Compliance and Risk (5)**

This criterion was intended to evaluate the risks of failing to meet 100% Beneficial reuse regulatory compliance from an environmental standpoint. This criterion is based on the assumption that Class B biosolids would have limited options other than landfill. Landfilling of biosolids has a significant environmental impact as result of GHG emissions several times larger than other sources of GHG emissions.

#### **Flexibility to Meet Future Regulations (5)**

Increasing concern over emerging contaminants has become a hot topic for biosolids management programs. As research and studies continue develop the understanding of the health and environmental risk of these compounds, future regulations may be a possible outcome. This criterion considers whether the selected scenarios have any potential to reduce these compounds. General research has suggested that biological processes are less capable of removal of CEC when compared to thermal and chemical based processes.

### **Economic Category**

#### **Lifecycle Cost (10)**

Net present worth (NPW) lifecycle costs for capital cost and operations and maintenance (O&M) for each scenario was considered. This cost reflects a 20-year useful service life of each scenario and reflect the potential impacts of O&M to a project. Estimated O&M costs included annual salaries for King County staff to operate and maintain the proposed facilities, general equipment maintenance, energy and material costs, and other related costs.

#### **Capital Cost (5)**

Capital costs are the costs associated with the procurement of equipment and construction for each scenario. These costs reflect the upfront cost of the project. Capital cost and O&M can have different impacts on utilities based on available funds and funding sources.

### **Market Diversification and Risk (10)**

Market diversification is indicative of a more sustainable biosolids management program as there is flexibility to shift to different markets when circumstances can reduce demand in others. Exposure to only a single market can put a program at risk. This situation has been seen around the country as a result of legal action, climate change, or negative media. When demand changes unexpectedly for a single market program, the only viable option tends to be landfilling which has financial implications. For this criterion, favorable ratings are given to scenarios that can generate a diversified biosolids program. This criterion considers the financial risk of low market diversification. Class A biosolids generally have more alternative avenues for end-users compared to Class B biosolids and will receive higher scores.

### **Technical Category**

#### **Process Reliability (10)**

Process reliability refers to the resiliency of a technology or process. Proven and mature technologies have long track records, wide adoption, and comprehensive experience. These generally reflect a decrease in risk in the adaption and long-term use of a technology or process.

#### **Constructability/Footprint (3)**

The limitation of space and high cost of land can make it challenging to implement projects of large scale. This criterion is intended to take into consideration the challenges of construction and the required amount of footprint of each scenario.

#### **Site Permitting (2)**

Site permitting can be challenging due to a variety of different regulations including, stormwater, air, and site restrictions. This criterion is intended to consider the challenge of permitting on-site and off-site locations.

#### **Solids Handling Capacity Impact (5)**

King County has seen a drastic increase in population over the last two decades and is projected to continue to grow. As population grows, available capacity will decrease resulting in required improvements in solids handling capacity. Intensification processes can increase capacity without significant construction requirements. Scenarios will be rated based on their abilities to increase capacity.

#### **Compatibility with Capital and Planning Projects (5)**

This criterion is intended to evaluate the compatibility of the scenarios with future capital and planning projects. This can include impacting future processes/projects such as nitrogen removal.

#### **Operational Complexity (5)**

The addition of processes and technologies can increase the complexity of the plant making it more challenging to operate.

## Appendix B

### Combined Financial, Environmental, and Social Costs and Benefits

#### Triple Bottom Line (TBL)

The triple bottom line, an analysis method to account for environmental, economic, and social factors, and is commonly used in planning or feasibility studies to evaluate King County alternatives, options, and projects. This triple bottom line analysis was adapted from the [King County Biosolids Program Strategic Plan 2018-2037](#) completed in 2018. The triple bottom line analysis was modified to be more robust and to better align with King County priorities, through the addition of a technical category, consideration of market risk and continuation of 100 percent beneficial reuse, and expanded equity and social justice criteria. Four criteria categories were developed for this effort: social, environmental, economic, and technical. The criteria include King County priorities as well as the Biosolids Program's objectives, especially around risk reduction and resiliency.

#### Social and Equity Criteria Category

The social and equity criteria category considered how each scenario could increase or decrease the quality of life of King County residents, taking into account the differing baselines for the communities around South, West Point, and Brightwater Treatment Plants. The criteria were adapted from the County's [The Determinants of Equity Report](#). *Scenario One: Base-case Class B* scored highest in this category because it did not require any additional construction in overburdened areas. The other two scenarios' scores were similar. However, *Scenario Two: 100 Percent Class A* is better able to support the production of healthy, local food and community education programs and opportunities.

#### Environmental Criteria Category

King County is dedicated to environmental stewardship and has adopted several initiatives to tackle climate change. As part of the *2015 Strategic Climate Action Plan*, the County has committed to meeting countywide GHG emissions reduction targets of 50 percent by 2030 and 80 percent by 2050. Additionally, WTD has set a target goal of carbon-neutral operations by 2025. The environmental criteria category takes into consideration these goals and other environmental criteria. *Scenario One: Base-case Class B* and *Scenario Two: 100 Percent Class A* both scored well in this category. *Scenario Three: Pyrolysis* scored significantly lower due to high greenhouse gas emissions and high energy and fossil fuel use, as well as a higher risk of not 100 percent beneficially reusing biosolids, as required by Washington State Regulations.

#### Economic Criteria Category

The economic criteria category considers the capital and operation and maintenance costs of the scenarios, including transportation. This category also evaluates the long-term sustainability of the biosolids management program in terms of diversification of outlets for biosolids application and risks associated with the single option program. *Scenario Two: 100 Percent Class A* scored highest in this category, despite moderate capital costs due to high diversification of products and consequently lower risks. *Scenario 3: Pyrolysis* scored lowest in this category, due to lack of diversification, high capital costs, and uncertain market conditions for biochar.

#### Technical Criteria Category

Different technologies offer varying levels of operation, footprints, permitting requirements, and improvements to existing processes. This category considers the technical components of each scenario. *Scenario One: Base-case Class B* and *Scenario Two: 100 Percent Class A* both scored well in this category. Both scenarios use reliable processes and are operationally feasible. *Scenario Two: 100 Percent Class A*

scored well due to addressing solids handling capacity effectively and being relatively simple (if costly) to construct. *Scenario Three: Pyrolysis* scored lower due to lack of process reliability, potential difficulty in site permitting, and high operational complexity.

#### Triple Bottom Line Score Summary

The scores for the four criteria categories were combined for the total scores for each scenario. High weighted scores represent the best scenarios. Total scores were out of 100 points, with 80-100 representing “very high”, 60-80 representing “high”, 40-60 representing “medium”, 20-40 representing low, and 0-20 representing “very low”.

Triple bottom line total score was very high for *Scenario Two: 100 Percent Class A*, high for *Scenario One: Base-case Class B*, and medium for *Scenario Three: Pyrolysis*.

- *Scenario Two: 100 Percent Class A* had the highest overall score due to very high scores in greenhouse gas emissions, flexibility to meet future regulations, market diversification/risk and solids handling capacity. This scenario had high to very high scores in all other criterion except noise, odor, traffic and capital costs. Noise, odor, and traffic are equity impacts that would need to be considered and properly mitigated in siting of a facility.
- *Scenario One: Base-case Class B* had high to very high scores in all criterion except flexibility to meet future regulations and market diversification/risk, a highly weighted criterion.

*Scenario Three: Pyrolysis* scored low to medium in each individual criteria category. Lower scoring criterion for pyrolysis included greenhouse gas emissions, energy use, regulatory compliance and beneficial use, capital cost, market risk/diversification, process reliability, and permitting.

## Certificate Of Completion

|  |                              |
|--|------------------------------|
| Envelope Id: E20FD4A9EFDD4FFFB2F5F17D142CD84D                              | Status: Completed            |
| Subject: Please DocuSign: Motion 15694.docx, Motion 15694 Attachment A.pdf |                              |
| Source Envelope:   |                              |
| Document Pages: 2  | Signatures: 2                |
| Supplemental Document Pages: 154   | Initials: 0                  |
| Certificate Pages: 2   | Envelope Originator:         |
| AutoNav: Enabled   | Angel Allende                |
| Envelopeld Stamping: Enabled   | 401 5th Ave                  |
| Time Zone: (UTC-08:00) Pacific Time (US & Canada)                          | Suite 100                    |
|  | Seattle, WA 98104            |
|  | Angel.Allende@kingcounty.gov |
|  | IP Address: 198.49.222.20    |

## Record Tracking

|                                      |                                 |                    |
|--------------------------------------|---------------------------------|--------------------|
| Status: Original                     | Holder: Angel Allende           | Location: DocuSign |
| 10/28/2020 10:31:17 AM               | Angel.Allende@kingcounty.gov    |                    |
| Security Appliance Status: Connected | Pool: FedRamp                   |                    |
| Storage Appliance Status: Connected  | Pool: King County General (ITD) | Location: DocuSign |

## Signer Events

Claudia Balducci  
 claudia.balducci@kingcounty.gov  
 King County General (ITD)  
 Security Level: Email, Account Authentication (None)

## Signature

DocuSigned by:  
  
 7E1C273CE9994B6...  
 Signature Adoption: Pre-selected Style  
 Using IP Address: 198.49.222.20

## Timestamp

Sent: 10/28/2020 10:32:06 AM  
 Resent: 10/28/2020 10:32:24 AM  
 Viewed: 10/30/2020 1:30:49 PM  
 Signed: 10/30/2020 1:31:12 PM

## Electronic Record and Signature Disclosure:

Not Offered via DocuSign  
 Supplemental Documents:

Motion 15694 Attachment A.pdf

Viewed: 10/30/2020 1:30:55 PM  
 Read: Not Required  
 Accepted: Not Required

Melani Pedroza  
 melani.pedroza@kingcounty.gov  
 Clerk of the Council  
 King County Council  
 Security Level: Email, Account Authentication (None)

DocuSigned by:  
  
 8DE1BB375AD3422...  
 Signature Adoption: Uploaded Signature Image  
 Using IP Address: 198.49.222.20

Sent: 10/30/2020 1:31:19 PM  
 Viewed: 10/30/2020 1:36:05 PM  
 Signed: 10/30/2020 1:36:22 PM

## Electronic Record and Signature Disclosure:

Not Offered via DocuSign  
 Supplemental Documents:

Motion 15694 Attachment A.pdf

Viewed: 10/30/2020 1:36:09 PM  
 Read: Not Required  
 Accepted: Not Required

## In Person Signer Events

## Signature

## Timestamp

## Editor Delivery Events

## Status

## Timestamp

## Agent Delivery Events

## Status

## Timestamp

## Intermediary Delivery Events

## Status

## Timestamp

## Certified Delivery Events

## Status

## Timestamp

| <b>Carbon Copy Events</b> | <b>Status</b> | <b>Timestamp</b> |
|---------------------------|---------------|------------------|
|---------------------------|---------------|------------------|

| <b>Witness Events</b> | <b>Signature</b> | <b>Timestamp</b> |
|-----------------------|------------------|------------------|
|-----------------------|------------------|------------------|

| <b>Notary Events</b> | <b>Signature</b> | <b>Timestamp</b> |
|----------------------|------------------|------------------|
|----------------------|------------------|------------------|

| <b>Envelope Summary Events</b> | <b>Status</b> | <b>Timestamps</b> |
|--------------------------------|---------------|-------------------|
|--------------------------------|---------------|-------------------|

|                     |                  |                        |
|---------------------|------------------|------------------------|
| Envelope Sent       | Hashed/Encrypted | 10/28/2020 10:32:06 AM |
| Certified Delivered | Security Checked | 10/30/2020 1:36:05 PM  |
| Signing Complete    | Security Checked | 10/30/2020 1:36:22 PM  |
| Completed           | Security Checked | 10/30/2020 1:36:22 PM  |

| <b>Payment Events</b> | <b>Status</b> | <b>Timestamps</b> |
|-----------------------|---------------|-------------------|
|-----------------------|---------------|-------------------|