

ATTACHMENT A:

LEASE AGREEMENT

THE SUQUAMISH TRIBE
PORT MADISON INDIAN RESERVATION
RESOLUTION 2016-139

Approving and Authorizing the Execution of a Lease Agreement
Between the Suquamish Tribe and King County Puget Sound Emergency Radio Network

WHEREAS, the Suquamish Tribal Council is the duly constituted governing body of the Port Madison Indian Reservation by authority of the Constitution and Bylaws for the Suquamish Tribe of the Port Madison Indian Reservation, Washington as approved on July 2, 1965, by the Under-Secretary of the United States Department of the Interior; and

WHEREAS, under Article III of the Constitution and Bylaws of the Suquamish Tribe, the Suquamish Tribal Council ("Tribe or Tribal Council") is charged with the general governance of the Port Madison Reservation and to this end, has the power, right and authority under the Tribe's Constitution to enter into agreements with other entities, to acquire, manage, lease, use and contract with for all Tribal real property together with all improvements, and to take all actions necessary to carry such duties into effect, which promote the social and economic welfare of the Suquamish people; and

WHEREAS, the Tribal Council has determined that leasing a cell tower located at 22063 Dewberry Rd. NE, Indianola, WA 98342 on Allotment 114-T1045 to King County for the Puget Sound Emergency Radio Network ("PSERN") promotes the general welfare of the Tribe and its members and the Suquamish Community; and

WHEREAS, the Tribe and King County PSERN (the "Parties") have each agreed to lease said Premises for a twenty-five (25) year term at an initial rental rate of \$34,101.12 with an annual increase of 2.25% of the previous year's rent; and

WHEREAS, the Parties have negotiated a Business Lease.

NOW, THEREFORE, BE IT RESOLVED that the Suquamish Tribal Council hereby authorizes the Tribal Chairman and Vice-Chairman, or their designees, to approve and execute the Agreement between King County PSERN and the Tribe and any necessary amendments thereto and to submit the executed lease for approval by the Bureau of Indian Affairs as required by 25 CFR 162, Subpart D.

CERTIFICATION

The foregoing resolutions were duly adopted on August 29, 2016, at a regular meeting of the Suquamish Tribal Council at which a quorum was present, by a vote of 4 for and 0 against, with 0 abstention(s), in accordance with and pursuant to the authority vested in it by the Constitution and Bylaws of the Suquamish Indian Tribe.

By:

Leonard Forsman, Chairman

Attest:

Nigel Lawrence, Secretary

SUQUAMISH TRIBE
AND
KING COUNTY

LEASE AGREEMENT

THIS LEASE AGREEMENT ("Lease"), made and entered into by and between the Suquamish Tribe of the Port Madison Indian Reservation, a federally recognized Indian Tribe organized pursuant to Section 16 of the Indian Reorganization Act of 1934 (25 U.S.C. § 476), hereinafter referred to as the LESSOR or TRIBE, owner of trust lands located within the exterior boundaries of the Port Madison Indian Reservation, acting by and through the Superintendent, Puget Sound Agency, Bureau of Indian Affairs, Department of the Interior, pursuant to the provisions of Federal law, and King County, a political subdivision of the State of Washington, hereinafter referred to as the LESSEE, collectively referred to as the "Parties," is established to provide for the following:

1. LEASED FACILITIES.

A. The Lessor, whose address is 18490 Suquamish Way, Suquamish, WA 98392, hereby leases to Lessee, whose address is 500 Fourth Avenue, Suite 830, Seattle, Washington 98104, those premises reasonably necessary for the Lessee to install, operate, and maintain structures, equipment and other property necessary to operate an emergency radio network communication site, to include ingress and egress at the Indianola Forest and Cell Tower Site ("Site"), Allotment 114-T1045, which Site is situated on Parcel No. 112602-2-007-2000 ("Property"), 22063 Dewberry Rd NE, Indianola, WA, located on the Port Madison Indian Reservation, Kitsap County, State of Washington, and legally described in Exhibit A and depicted in Exhibit B, attached hereto and incorporated herein by this reference (hereinafter designated as the "Leased Premises").

B. The portion of the Leased Premises leased by Lessor to Lessee shall include those portions of the real property described above, and of an existing tower owned by Lessor on that real property, that are reasonably necessary for Lessee to fulfill its obligations under this Lease, but no more. Lessee's rights to use the real property described above, and the existing tower on that Property, are not exclusive but are shared with the Tribe and with pre-existing and/or future Lessees.

C. Lessor hereby acknowledges that Lessee plans to fund, procure sites for such emergency radio network communication facilities, and along with other municipalities in King County establish the Puget Sound Emergency Radio Network (the "PSERN System") to eventually provide service in King County as authorized by Proposition 1 and King County Ordinances 17993, 18074 and 18075.

2. TERM.

The "Effective Date" of this Lease is the date the Lease is approved by the Superintendent, Bureau of Indian Affairs – Puget Sound Agency, and signed by both Lessor and Lessee. The term

of this Lease is twenty-five (25) years, beginning on the first day of the month after the date Lessee commences construction of the Communication Facilities (defined below) or twenty-four (24) months after the Effective Date of this Lease, whichever is earlier ("Lease Commencement Date") and ending on the twenty-fifth anniversary of the Lease Commencement Date.

3. RENT.

A. Upon the Lease Commencement Date, Lessee shall pay Lessor \$34,101.12, in advance, as Annual Rent for the first year of this Lease. Upon the first anniversary of the Lease Commencement Date and each anniversary thereafter, the Annual Rent shall increase by 2.25% annually throughout the entire Lease term. See the Lease Rate Schedule attached hereto as Exhibit C and incorporated herein by this reference.

B. Rent for partial lease years shall be prorated and if Rent is ever overpaid it shall be either refunded or applied to future payments at Lessee's discretion. Rent shall be made payable to Lessor and sent to Lessor's address as set forth in Section 35 herein, or as directed by Lessor from time to time.

4. PERMITTED USES.

A. Lessee shall have the right to use and possess the Site for purposes involving, relating to or supporting telecommunications (the "Permitted Uses"). The term "Permitted Uses" expressly includes, without limitation, the right to install and maintain on the Site communication facilities, including, without limitation, radio and other storage structures and other improvements relating thereto (collectively, "Communication Facilities"). All Communication Facilities installed by Lessee shall be deemed personal property, and Lessee shall retain title to all such Communication Facilities. Lessee shall comply with all applicable laws in connection with the Permitted Uses and Communication Facilities.

B. Lessee shall have the right to modify, supplement, replace, upgrade or relocate the Communication Facilities on the Site at any time during the Lease term so long as such activity is consistent with the Permitted Uses and the Lessee receives written consent from the Lessor, which consent shall not be unreasonably withheld, delayed or conditioned. Lessee may erect fences or other barriers to prevent interference with its Communication Facilities.

C. Lessee shall have the right to install necessary utilities, including without limitation conduit and sleeving, for its Communication Facilities to the point of connection within its equipment shelter. Lessee may install a separate electric meter for its electric service on the Leased Premises.

D. Lessee shall have the right to use the existing access road connecting to Dewberry Road for purposes of vehicular and pedestrian access to the Site without Lessor's consent. Lessor shall provide Lessee with access to the Site twenty-four (24) hours per day, seven (7) days per week. Lessor has fenced the exterior of the tower base and will provide Lessee with two (2) keys to the Site. Additional keys will be provided at a cost of \$10 per key.

5. NON-INTERFERENCE.

A. Lessee shall not use the Site in any way that interferes with the existing use by (i) Lessor or (ii) tenants or licensees of Lessor holding rights to the Lessor's Property on the Effective Date ("Existing Tenants").

B. Lessor warrants to Lessee the use and quiet enjoyment of the Site. Lessor agrees that it shall not use, or shall it permit its tenants, employees, invitees or agents to use, any portion of the Site or Lessor's Property in any way which would interfere with Lessee's telecommunications operations, provided that continued use by Lessor or Existing Tenants in the same manner as existed as of the Effective Date shall not constitute interference with Lessee's telecommunications operations.

C. In the event Lessor elects to permit a third party to use any of Lessor's Property for the purpose of installing communication facilities, Lessor shall, thirty (30) days prior to the issuance of such authority, deliver to Lessee engineering studies or other appropriate evidence that such use will not interfere with Lessee's operations at the Site. Should Lessee determine, based on such materials or on its own studies, that the third party will interfere with Lessee's operations, and so notifies Lessor in writing, then Lessor shall not permit the third party to use the Lessor's Property.

6. ENVIRONMENTAL MATTERS.

A. Lessor represents and warrants to Lessee that Lessor is not aware of any Hazardous Substances located on the Property in soil, groundwater, or other environmental media, or in violation of applicable laws. Lessee and Lessor agree that they will not place, dispose of or store any Hazardous Substances on the Leased Premises or the Property in violation of applicable laws. The Parties acknowledge that, consistent with this Section, Lessee may be installing on the Leased Premises backup power devices such as batteries and generators with petroleum or propane fuel storage tanks.

B. Lessee shall indemnify, defend and hold harmless Lessor with respect to any and all claims, demands, suits, causes of action, judgments, damages, costs, attorney fees, government orders, penalties, or other requirements (hereafter "Claims") arising from the release of any Hazardous Substances on the Leased Premises caused by Lessee, its employees or agents, except to the extent that a Claim is caused by the Lessor, its employees or agents, another tenant, its employees or agents, or a third party.

C. Lessor shall indemnify, defend and hold harmless Lessee with respect to any and all Claims arising from the presence or release of any Hazardous Substances on the Property, except to the extent that a Claim is caused by Lessee, its employees or agents.

D. For purposes of this Lease, "Hazardous Substances" shall mean any substance subject to regulation under the Washington Hazardous Waste Management Act (Ch. 70.105 RCW) and implementing regulations, any "hazardous substance" under the Washington Model Toxics Control Act (Ch. 70.105D RCW) and implementing regulations, and any "hazardous substance" or "hazardous waste" as defined by the Comprehensive

Environmental Response, Compensation and Liability Act of 1980 (42 USC §§ 9602 et seq.) and implementing regulations, as these laws are amended from time to time; underground storage tanks, whether empty, filled or partially filled with any substance; asbestos; urea formaldehyde foam insulation; PCBs; and any other substance, waste, material or chemical deemed or defined as hazardous, toxic, a pollutant, contaminant, dangerous or potentially dangerous, noxious, flammable, explosive, or radioactive, the removal of which is required or the manufacture, preparation, production, generation, use, maintenance, treatment, storage, transfer, handling, or shipment of which is restricted, prohibited, regulated or penalized by any federal, state, county, municipal or other local governmental statute, regulation, ordinance or resolution as these laws are amended from time to time.

E. The obligations of this Section shall survive the expiration or other termination of this Lease.

F. Prior to commencement of construction of the Communication Facilities on the Site, Lessee shall perform any environmental assessment required for Lessee's Permitted Use by any local, state, tribal or federal authorities.

7. RENEWAL/CANCELLATION/DEFAULT.

A. This Lease may be renewed for an additional twenty-five (25) year term or for a term of less than twenty-five (25) years by mutual agreement in writing. The consideration for this Lease is subject to adjustment at the time of any such renewal by agreement of the parties.

B. This Lease may be terminated by Lessee for any reason or no reason by giving ninety (90) days notice in writing to Lessor, and if the effective termination date is after the Lease Commencement Date Lessee shall pay Lessor an early termination fee equal to three (3) months of the then current Rent on or before the effective termination date. Lessee may also terminate this Lease upon thirty (30) days written notice to Lessor if (i) Lessee determines that it cannot obtain the Government Approvals required to employ the Site for the use described in this Lease, or if any necessary approval is revoked or terminated, or (ii) if Lessee or Lessee's vendor of the PSERN System determines that, for technical, design, interference, environmental, economic or title reasons, the Site is not necessary or suitable for the operation of the PSERN System or the use described in this Lease.

C. In the event that Lessor elects to no longer use the Property as a communication facility, Lessor shall have the right to terminate this Lease by giving one (1) year prior written notice thereof to Lessee.

D. In accordance with Federal law the Secretary of the United States Department of the Interior ("Secretary") may terminate this Lease for Lessee's failure to comply with any material term or condition of this Lease or applicable Federal law; *provided*, that this Lease shall not be terminated if: (a) Lessee's failure is cured within thirty (30) days of notice of

such failure; or (b) Lessee's failure pertains to a matter other than the payment of any monies due under this Lease, Lessee promptly commences to cure the failure, Lessee diligently pursues such action with continuity to completion, and completion takes place within such reasonable time as may be specified by the Secretary.

E. If Lessor should fail to remedy any default in the keeping of any term, covenant or condition herein with all reasonable dispatch, within a reasonable period of time no sooner than thirty (30) days after receipt of written notice within which time frame said default has not been cured, then in any of such event(s), Lessee shall have the right, at its option, in addition to and not exclusive of any other remedy Lessee may have by operation of applicable laws, to remedy Lessor's failure to perform or terminate this Lease upon written notice to Lessor.

F. Subject to Sections 8.B and 28 herein, upon termination or expiration of this Lease, Lessee shall remove its equipment and/or improvements and will restore the Site to substantially the same condition existing as of the Lease Commencement Date, normal wear and tear and damage beyond Lessee's reasonable control excepted.

8. OWNERSHIP OF PERSONAL PROPERTY PLACED BY LESSEE.

A. Title to any improvements, including but not limited to a building or equipment, installed and/or located on the Leased Premises by the Lessee shall vest and remain with the Lessee. Lessor hereby waives any and all lien rights it may have, under any theory of law, statute or otherwise, concerning the Lessee's improvements or any portion thereof on the Leased Premises. All buildings, tower, equipment or other improvements existing on the Leased Premises prior to the Effective Date of this Lease, or placed by Lessor on the Leased Premises subsequent to the Effective Date of this Lease, shall be and remain the property of the Lessor during the term of this Lease, including any renewal thereof.

B. Lessee shall have the right to remove its improvements at any time prior to and within sixty (60) days after the expiration or earlier termination of this Lease, subject to Section 28 below; provided, however, upon receipt of Lessor prior written consent, Lessee may elect not to remove all or any of its improvements from the Property.

9. EXISTING AUTHORIZED USES.

Lessee's rights under this Lease are subject to any prior valid existing right or adverse claim. Lessee's rights under this Lease are subject to existing authorized uses of the Leased Premises (including existing use for the installation, operation and transmission of utility services by the Tribe and/or by third parties authorized by the Tribe, including Tribal utilities, water, sewer, electric, natural gas, television, telephone, fiber optic and data); *provided*, however, such existing authorized uses do not interfere with Lessee's activities that are authorized by this Lease.

10. COMPLIANCE WITH LAW.

Lessee, its employees, agents, and contractors (including subcontractors) shall comply with all applicable Tribal, Federal and State laws when conducting any activity pursuant to this Lease that occurs upon or affects the Leased Premises.

11. UTILITIES.

Lessor shall furnish power to the Lessee's Communication Facilities as of the Lease Commencement Date. In the event that the Lessee requires other utilities, Lessee shall have the right to obtain such utilities from a servicing utility provider, the installation and maintenance thereof shall be the Lessee's sole obligation, provided that the location of such installation shall be subject to the written consent of the Lessor, which the Lessor will not unreasonably withhold, delay or condition. The Lessee shall pay, as they become due, all bills for electricity and other utilities that are furnished to the Communication Facilities. In the event Lessee cannot secure its own metered electrical supply, Lessee may submeter from Lessor, in which event Lessee will read the submeter on an annual basis and will reimburse Lessor on each anniversary of the Lease Commencement Date for the electricity used by Lessee during the prior lease year.

12. EXISTING UTILITIES.

Lessee will seek to locate all existing utilities prior to, and avoid any damage to existing utilities during, use of the rights granted under this Lease. Lessee will cooperate with utility owners and/or operators to arrange for the prompt repair of any such damage, and shall promptly reimburse the utility owner and/or operator for the cost of such repair.

Lessee shall comply with RCW 19.122 "Underground Utilities" (or any future successor of or replacement for RCW 19.122), in connection with this Lease and any activity it undertakes or utilities it installs pursuant to this Lease. Such compliance shall be in addition to, and not a replacement for or excuse from, compliance with any otherwise applicable existing or future Tribal law or requirement of this Lease.

13. LESSOR'S USE OF PROPERTY.

Lessee shall have exclusive use of those areas on the Site where the Communication Facilities are installed, provided that Lessee's use of access and utility easements and routes on the Property shall be non-exclusive. Lessor reserves the right to use the Leased Premises for those purposes set out in Section 24 herein below, provided such use is not inconsistent with the rights herein granted. Lessee agrees not to interfere with the use of the Leased Premises for any purpose not inconsistent with the primary purpose for which this Lease was entered into.

14. WORKMANLIKE MANNER.

Lessee and its employees, agents and contractors (including subcontractors) shall exercise the rights conveyed by this Lease in a workmanlike manner.

15. PERMITS.

Before beginning any activity on the Leased Premises, Lessee, its employees, agents, and contractors (including subcontractors) shall obtain all necessary permits, including all necessary Tribal, Federal or State permits, licenses and approvals ("Government Approvals"), in connection with Lessee's occupancy and use of the Leased Premises, including any survey, construction, operation, inspection, alteration, improvement, maintenance, replacement, or repair activity in the Leased Premises. Lessee, its employees, agents and contractors (including subcontractors) shall comply with any and all conditions of said Government Approvals and shall conform all activity and work to applicable site plans associated with Government Approvals. Lessor hereby authorizes Lessee to make and sign as Lessor's agent any and all applications and/or submissions necessary to obtain all Government Approvals from all applicable governmental and/or regulatory entities required for Lessee's Permitted Use of the Communication Facilities within the Site. Lessor agrees to reasonably assist Lessee with such applications and with obtaining and maintaining the Government Approvals during the term of this Lease.

16. FIRE CONTROL.

Lessee will conduct its activities on and near the Leased Premises so as to reasonably prevent fires on or near the Leased Premises.

17. CULTURAL RESOURCES.

Lessee agrees that during the term of this Lease, if any previously unidentified cultural resources are discovered within the Leased Premises, that any activity that disturbs or threatens to disturb such cultural resources shall be halted immediately and the Tribe shall be contacted immediately.

18. HOLD HARMLESS.

A. Lessee agrees to indemnify and hold Lessor harmless as provided herein to the maximum extent possible under law. Accordingly, Lessee agrees for itself, its successors, and assigns, to defend, indemnify, and hold harmless Lessor, its appointed and elected officials, and employees from and against liability for all Claims, including costs of defense thereof for injury to persons, death, or property damage which is caused by or arises out of Lessee's exercise of rights and privileges granted by this Lease, except to the extent of the Lessor's negligence.

B. Lessor agrees to indemnify and hold Lessee harmless as provided herein to the maximum extent possible under law. Accordingly, the Lessor agrees for itself, its successors, and assigns, to defend, indemnify, and hold harmless Lessee, its appointed and elected officials, and employees from and against liability for all Claims, including costs of defense thereof for injury to persons, death, or property damage which is caused by or

arises out of Lessor's exercise of rights and privileges granted by this Lease, except to the extent of the Lessee's negligence.

C. Where such Claims result from the concurrent negligence of the Parties, the provisions provided in this Section shall be valid and enforceable only to the extent of each party's negligence.

D. Each of the Parties agrees that its obligations under this Section 18 extend to any Claim brought by, or on behalf of, any of its employees or agents. For this purpose, each of the Parties, by mutual negotiation, hereby waives, with respect to the other party only, any immunity that would otherwise be available against such Claims under the industrial insurance provisions of Title 51 RCW; provided that such waiver of immunity shall apply only in the event that both parties carry industrial insurance in compliance with Title 51 RCW.

E. In the event that any of the Parties incurs any judgment, award, and/or cost arising therefrom, including attorney fees, expenses, and costs shall be recoverable from the responsible party to the extent of that party's negligence.

F. The provisions of this Section 18 do not apply to Claims that are subject to Section 6.

19. FEDERAL SUPERVISION.

A. As long as the Leased Premises is held in trust or restricted status by the Secretary, all of Lessee's obligations under this Lease, and the obligations of its sublessees, assignees and sureties, shall be to the United States as well as to Lessor. Nothing contained in this Lease shall operate to delay or prevent a termination of federal trust responsibilities with respect to the Leased Premises by the issuance of a fee patent or otherwise during the term of the Lease; however, such termination shall not serve to abrogate the Lease. In the event of such termination, all powers, duties or other functions of the United States or its authorized representative shall terminate, and the responsibilities for enforcing compliance with the covenants of this Lease shall be assumed by the Lessor or successors in interest. The owners of the Leased Premises and the Lessee, its sublessees and assigns and their sureties shall be notified of any such change in the status of the Leased Premises.

B. No member of Congress or any delegate thereto shall be admitted to any share or part of this Lease or to any benefit that may arise here from.

C. It is understood and agreed that violations of this Lease shall be acted upon in accordance with the regulations in 25 CFR 162.

D. It is understood and agreed that this Lease shall be valid and binding only after approval by the Secretary of the Interior as evidenced by the Secretary's signature on this Lease below.

20. ASSIGNMENT AND SUBLEASE.

A. Lessee shall not assign or sublet this Lease, in whole or in part, without the prior written consent of the Lessor and the United States, which consent shall not be unreasonably withheld, delayed or conditioned.

B. Any sublessee or assignee shall comply with all applicable laws of the Tribe and the United States.

C. Lessor acknowledges that Lessee and other municipalities participating in the PSERN System intend to establish a new governmental non-profit entity that will eventually own and operate the PSERN System. Notwithstanding anything in this Lease to the contrary, Lessee may assign its interest in this Lease, without the United States or Lessor's consent, to that governmental non-profit entity or to any entity existing now or in the future that will be responsible for the operation, maintenance, management, updating and upgrade or replacement of the PSERN System as authorized by law.

D. In the event of an assignment, the assignee shall assume all liability of the assignor and Lessee will be relieved of all future performance, liabilities and obligations under this Lease to the extent of such assignment.

21. MODIFICATIONS AND AMENDMENTS.

Any modifications or amendments to this Lease must be approved in writing by the Lessor, Lessee and the Secretary.

22. LATE PAYMENT INTEREST.

It is understood and agreed between the parties hereto that, if any installment of rent is not paid within sixty (60) days after becoming due, interest will be assessed at twelve percent (12%) per annum, from the date due until paid in full.

23. INSURANCE.

A. Lessee maintains a fully funded Self-Insurance program for the protection and handling of the Lessee's liabilities including injuries to persons and damage to property.

B. Lessor acknowledges, agrees and understands that Lessee is self-funded for all of its liability exposures. Lessee agrees, at its own expense, to maintain, through its fully funded Self-Insurance program, coverage for all of its liability exposures for this Lease. Lessee

agrees to provide Lessor with at least thirty (30) days prior written notice of any material change in Lessee's self-funded insurance program and will provide Lessor with a letter of self-insurance as adequate proof of coverage. Lessor further acknowledges, agrees and understands that Lessee does not purchase Commercial General Liability insurance and is a self-insured governmental entity; therefore Lessee does not have the ability to name Lessor as an additional insured.

C. If Lessor is not a governmental agency which maintains a fully funded Self-Insurance program in accordance with applicable law, Lessor will maintain Commercial General Liability insurance in the amount of One Million Dollars (\$1,000,000) per occurrence and Two Million Dollars (\$2,000,000) general aggregate, based on ISO Form CG 00 01 or equivalent, and will include Lessee as an additional insured with respect to claims arising out of or related to this Lease.

D. Lessor shall carry "All Risk" property insurance in an amount equal to the full replacement value of its improvements on the Property, including Lessor's existing tower.

E. Lessee shall maintain "All Risk" property insurance in an amount equal to the full replacement value of all its improvements and personal property located on the Premises or shall self-insure improvements and personal property on the Premises.

24. RESERVATIONS.

Lessee shall use the Site exclusively for purposes of communications, except as otherwise agreed to by the parties in writing. Any rights not expressly provided are reserved by the Lessor, including:

Minerals: The Lessor reserves all rights, as owned by the Lessor, to all mineral rights, including but not limited to oil, gas, or hydrocarbon substances, excluding those brought onto the Property by or at Lessee's direction for its use of the Communication Facilities.

Timber: The Lessor reserves all rights, as owned by the Lessor to timber and forest products on the Leased Premises.

Water: The Lessor reserves all rights, as owned by the Lessor, to water on, under, for the use of or reserved by the United States in connection with the reservation of the Leased Premises.

Easements and Rights of Way: The Lessor reserves the right to establish and utilize such easements, rights of way or service line areas as shall be reasonably necessary from time to time for the provision and installation of public infrastructure including but not limited to conveyances for water, sewer, gas, electrical, cable television, fiber optic, telephone and any other utility benefiting the Lessor.

25. ASSENT NOT WAIVER OF FUTURE BREACH OF COVENANTS.

No assent, express or implied, to any breach of any of the Lessee's covenants, shall be deemed to be a waiver of any succeeding breach of any covenants.

26. VIOLATIONS OF LEASE.

The negotiation and execution of this Lease shall be deemed by the Parties to have occurred within the Port Madison Indian Reservation and Lessee acknowledges that it has voluntarily entered into a consensual contractual relationship with the Tribe. Except for resolution of disputes, as provided in Section 33 herein, it is understood and agreed by the Parties that violations of this Lease shall be acted upon according to the laws of the Suquamish Tribe and, in the absence of any applicable Suquamish Tribal authority, according to the regulations in 25 C.F.R. Part 162 and all other applicable Federal statutory and regulatory provisions. Notwithstanding the forgoing, if there are any discrepancies between the terms of Section 33, Dispute Resolution, and the terms set forth in this Section, the terms of Section 33 shall control.

27. CARE OF PREMISES.

A. It is understood and agreed that the Lessee is to keep its Communication Facilities and those areas of the Site used exclusively by Lessee in good condition and repair. Lessee shall not commit or permit to be committed any waste whatever on the Leased Premises and shall not remove or tear down any building or other improvements thereto owned by another. Lessee shall not destroy or permit to be destroyed any trees, except with the consent of the Lessor, and shall not permit the Leased Premises to become unsightly. The Lessee will be held financially responsible for all unrepaired damages to improvements or appearance caused by Lessee, except for the usual wear, tear and decay.

B. Lessor shall maintain its tower, the Leased Premises and the Property (except for Lessee's Communication Facilities), including access to the Leased Premises from Dewberry Road, in good repair and tenantable condition during the term of this Lease.

C. Notwithstanding anything in this Lease to the contrary, Lessor shall not maintain, repair or otherwise touch or interfere with Lessee's Communication Facilities without Lessee's prior consent; provided that, in the event of an emergency posing an imminent threat of bodily injury or property damage, Lessor may take action necessary to abate the threat and shall give Lessee notice of such actions taken as soon as is reasonably possible thereafter.

28. SITE RESTORATION.

The Lessee shall surrender possession of the Leased Premises upon the expiration or termination of this Lease and, if required by the Lessor, shall within sixty (60) days thereafter, or within such additional time as may be mutually agreed upon, return the Leased Premises in as

good condition as is possible as that existing at the time of entering upon the same under this Lease, normal wear and tear and damage beyond Lessee's reasonable control excepted; provided that, if the Lessor requires the return of the Leased Premises in such condition, the Lessor shall give written notice thereof to the Lessee at least thirty (30) days before the expiration or termination of the Lease. The restoration of the Leased Premises as aforesaid shall include, but not be limited to, the removal of all debris, concrete slabs and foundations placed by Lessee; the filling of holes and depressions created by Lessee; and grading as required in conjunction with the foregoing. Failing to comply with this stipulation, Lessee agrees to bear all expenses and costs incurred by the Tribe and/or the United States in accomplishing said restoration.

29. INSPECTION OF THE PREMISES.

The Lessor and the Secretary, and their authorized representative shall have the rights, at any reasonable times during the term of this Lease, and with reasonable notice, to enter upon the Leased Premises, or any part thereof, to inspect the same and all buildings and other improvements erected and placed thereon.

30 COMPLETE AGREEMENT AND CONSTRUCTION.

A. This Lease contains the complete statement of the understanding of the Parties with respect to the subject matter of this Lease. There are no other representations, agreements, or understandings, oral or written, by the Parties relating to the subject matter of this Lease that are not fully expressed in this Lease. Each party acknowledges and represents to the other party that it is executing this Lease solely in reliance upon its own judgment and knowledge and that it is not executing this Lease based upon the representation or covenant of the other party, or anyone acting on such party's behalf, except as expressly stated herein.

B. This Lease has been freely and fairly negotiated by the Parties hereto, each of whom has had the full opportunity to consult legal counsel and to modify the draftsmanship hereof, and, therefore, the terms of this Lease shall be construed and interpreted without any presumption or other rule requiring constructional interpretation against the party causing the drafting of the Lease.

31. SEVERABILITY.

In the event any term or condition of this Lease or application thereof to any person or circumstance is held invalid, such invalidity shall not affect other terms, conditions, or applications of this Lease, which can be given effect without the invalid term, condition, or application. To this end, the terms and conditions of this Lease are declared severable; *provided*, however, that this paragraph is not applicable to the following paragraph 32 of this Lease.

32. TRIBAL SOVEREIGNTY.

This Lease shall in no manner diminish, affect or limit any aspect of the Tribe's jurisdiction, dominion or control, whether civil, criminal, regulatory, adjudicatory, licensing, taxation or otherwise, over the Leased Premises, or over anyone or anything thereon or therein, or any activities taking place on, over or under the Leased Premises, without regard to whether the person or entity being regulated is a Tribal member, other Native American or non-Indian person or entity, or State or local governmental authority. This provision is an essential and indivisible part of this Lease; should this provision, at the request of Lessee or its employees, agents, or contractors (including subcontractors), or any person or entity acting in concert with Lessee, be struck down, ruled unenforceable, or ineffective, or in any manner limited, this Lease shall be void and the rights granted by this Lease shall terminate immediately. Nothing whatsoever in this Lease constitutes or shall be construed as a waiver of Tribe's sovereign immunity, except to the extent the Tribe consents to the dispute resolution provisions provided in Section 33 below.

33. DISPUTE RESOLUTION.

A. Purpose. The Parties intend to resolve their disputes through direct discussion and, if such is not possible, then the Parties consent and will use the dispute resolution framework established in this Section. All stated time frames for resolving disputes may be lengthened by mutual consent.

B. Direct Discussions. To initiate dispute resolution under this Section, the complaining party will first submit a written complaint letter to the respective Parties' Representative (defined in Section 35) against whom a dispute is lodged, stating therein the nature of the dispute, the requested resolution, and the factual basis supporting the requested resolution. The responding party will, within ten (10) business days of receiving the complaint letter, provide a written response, stating its agreement or disagreement with the nature of the dispute and the requested resolution. If the responding party disagrees with the complaint or the proposed resolution, the written response must provide at least one alternate resolution and the factual basis supporting such resolution(s). Thereafter, the Representatives of each party will, for fifteen (15) business days, make a good faith attempt to resolve the dispute through one or more direct discussions. If no mutually acceptable resolution is reached, the Representatives will prepare a joint statement within five (5) business days, which includes a chronology, a synopsis of the discussions that took place and the last stated positions of each party.

C. Mediation. If direct discussions between the Parties fail to resolve the dispute, any participating party may, within five (5) business days of completing the direct discussion process, make a written request for mediation to be conducted in Seattle, Washington or at another place as the Parties may agree in writing. If all participating Parties agree to engage in mediation, the Parties shall seek a mutually acceptable mediator. If the Parties cannot reach agreement on the selection of the mediator within fifteen (15) business days of the date the written mediation request letter was received by the other party or Parties, the mediation will be administered by J.A.M.S., Seattle, Washington Office using a J.A.M.S. mediator and protocol, or another mutually agreeable dispute resolution service and

protocol. Enforcement of a mediation agreement reached shall be the same as enforcement of an arbitration decision as set forth herein. If a party objects to proceeding with mediation, then mediation may be bypassed, and the dispute resolved pursuant to arbitration as set forth herein.

D. Binding Arbitration. Should direct discussions prove unsuccessful in resolving the dispute, and either mediation is not requested, is bypassed, or is also unsuccessful, either the complaining or responding party may make a written demand for arbitration before a single arbitrator in Poulsbo, Washington or at another place as the Parties may agree in writing. If the Parties cannot reach agreement on the selection of the single arbitrator within fifteen (15) business days of the date the written demand letter was received, the arbitration will be administered by J.A.M.S., Seattle, Washington Office using a J.A.M.S. arbitrator, or another mutually agreeable dispute resolution service. Any arbitrator selected must have a fundamental knowledge of and at least five (5) years' legal experience in contract and construction law and a working knowledge of Indian law. The arbitrator shall have the power to establish a schedule for the hearing, which hearing shall be limited to no more than two (2) consecutive business days to be equally divided between the Parties, including preliminary discovery to the extent the arbitrator deems it necessary and proper under the circumstances, and there shall not be more than two (2) depositions allowed per party, to make reasonable rules and issue orders necessary for a fair and efficient conduct of the hearing, and to conduct the hearing and administer oaths and affirmations. The arbitrator's decision shall be accompanied by an explanation as to the basis for the award. Washington State contract law shall apply and govern with regard to any dispute over the interpretation of this Lease. Each party will pay for its own attorneys' fees, and both Parties shall share equally of cost of the arbitrator's fees. All arbitration awards shall be binding upon the Parties and except for a showing of fraud, collusion, or incapacity of the arbitrator, said award cannot be appealed. Relief may include temporary, injunctive or other provisional remedies, along with all other remedies available at law or in equity, except as expressly limited elsewhere in this Lease.

E. Enforcement of Arbitration Award. Upon the issuance of an arbitration award or mediation agreement, the prevailing party may seek the entry of judgment upon the award in any court of competent jurisdiction, which for purposes of Lessee's enforcement against Tribe means the Suquamish Tribal Court and for Tribe's enforcement against Lessee means federal court based upon diversity or other theory of jurisdiction. If federal court jurisdiction is not available, both Lessee and Tribe agree to submit to Kitsap County Superior Court for enforcement of the award against Lessee. The court of competent jurisdiction shall enforce the decision of the arbitrator and shall not modify, correct, alter or vacate said decision in any way, unless the court finds after notice and hearing upon application of a party to the arbitration, one or more of the following: (1) the arbitration decision was procured by corruption, fraud or undue means, (2) there was evident of corruption in the arbitrator, or (3) the arbitrator was guilty of the specific misconduct of refusing to hear evidence pertinent and material to the controversy which prejudiced the rights of a party. No court shall have jurisdiction to interfere in any way with any pending

arbitration. No party may seek from such court any provisional remedy pending appointment of the arbitrator or the arbitrator's rendition of the award. If the court vacates the arbitration decision, then the court shall direct a rehearing either before the same arbitrator or before a new arbitrator to be chosen in the manner provided in this Section.

F. Limited Waiver of Sovereign Immunity by the Tribe. Except for the limited waiver of sovereign immunity provided in this Section, nothing in this Lease shall be construed as a general or specific waiver of the Tribe's sovereign immunity, which immunities are expressly asserted. The Tribe hereby grants Lessee a limited waiver of sovereign immunity solely for the purpose of dispute resolution as provided in this Section, and such waiver shall not be extended to any other person, agency or entity, except a surety performing under the conditions set out in this Lease ("Limited Waiver"). This Limited Waiver applies only to contractual claims arising out of or under this Lease and does not apply to any non-contractual claims or to claims under any other agreement between the Parties. Furthermore, nothing contained in this Limited Waiver shall be construed to create a contractual relationship with or a cause of action in favor of any third party against the Tribe. This Limited Waiver applies only to the enforcement of a mediation agreement or an arbitration award against the Tribe, provided such mediation agreement or arbitration award has been secured in accordance with the provisions of this Lease.

G. No Requirement of Exhaustion of Tribal Court Remedies. The Parties acknowledge that under the limited waiver of sovereign immunity provided for herein, the assumption of jurisdiction by any arbitrator or court of competent jurisdiction shall not be delayed or curtailed by any doctrine requiring exhaustion of Tribal court remedies.

H. No Consent to Washington State Court. The Tribe expressly states and the Lessee understands and acknowledges that the Tribe does not consent to the jurisdiction of the State of Washington or any other state court for any purpose, except if necessary to enforce an award against Lessee as set forth above.

I. Provisional Remedy Pending Arbitration. The Parties hereby acknowledge and agree that the intent of the PSERN System is to provide dispatch services for first-responders and that any shut-down of Lessee's Communication Facilities, as a result of a dispute between the parties, would result in a failure of such emergency dispatch services in the geographic area covered by this Site. Therefore, notwithstanding anything to the contrary contained in this Lease, the Parties hereby agree that, so long as no emergency exists that would result in immediate bodily injury or death or sever property damage if the Communication Facilities remains operational, Lessee shall have the right to do all work necessary to maintain and operate the Communication Facilities, unobstructed, at all times when a dispute is ongoing between the parties, until the dispute has been resolved and enforced in accordance with the terms of this Section.

34. SUCCESSORS.

This Lease shall be binding upon and inure to the benefit of successors of both Parties.

35. NOTICES AND COMMUNICATIONS.

Lessee shall at all times keep Lessor and the Secretary informed of its address. The Tribe shall at all times keep Lessee informed of its address. Currently, all official notices required under this Lease shall be sent by certified mail, return receipt requested, or reliable overnight courier to the address listed below, and shall be deemed effective upon receipt, refusal or if returned undeliverable:

A. Notice to LESSEE:

King County Facilities Management Division
Real Estate Services
Attention: Leasing Supervisor
Re: Suquamish PSERN Lease
500 Fourth Avenue, Suite 830
Seattle, WA 98104

With Copy To:

King County Facilities Management Division
Director's Office
Attention: Gail Houser
RE: Suquamish PSERN Lease
500 Fourth Avenue, Suite 800
Seattle, WA 98104

With Copy To:

King County Department of Information Technology
Puget Sound Emergency Radio Network
Attention: Marlin Blizinsky
RE: Suquamish PSERN Lease
401 Fifth Avenue, Suite 600
Seattle, WA 98104

B. Notice to LESSOR:

Suquamish Tribe
Attn: Executive Director/Deputy Executive Director
PO Box 498
Suquamish, WA 98392

With a copy to:

Suquamish Tribal Attorney
PO Box 498
Suquamish, WA 98392

And, so long as the Leased Premises are held in trust or restricted status, a copy to:

United States Department of the Interior
Bureau of Indian Affairs
Puget Sound Agency
2707 Colby Avenue, Suite 1101
Everett, WA 98201

Both Parties shall appoint a representative to have responsibility for activities carried out under this Lease and to resolve any disputes that may arise between the Parties ("Representative"), which shall be resolved in accordance with Section 33, Dispute Resolution.

36. DISASTER. In the event the Leased Premises is destroyed or damaged by fire, earthquake or other casualty so as to render the Site unfit for Lessee's use as provided for herein, Lessee may terminate this Lease and shall be reimbursed for any unearned Rent that has been paid less any utility costs owing. If the Lessee believes it is feasible to relocate the Communication Facilities to a different location on the Property, the Parties agree that the Site will be relocated. Lessor will provide an interim site for Lessee to locate temporary, mobile Communication Facilities and equipment as necessary to continue service during repair or relocation of the of the Site or Communication Facilities. A survey will be prepared for the relocated Site (including access and utility easements) and the survey will replace Exhibit B attached hereto.

37. REPRESENTATIONS AND WARRANTIES

Lessor represents, warrants and agrees that: (i) the Property is held in trust by the United States of America, for the benefit of Lessor, and Lessor has the full right, power and authority to grant this Lease to Lessee subject to approval by the Bureau of Indian Affairs; (ii) the Property is not and will not be encumbered by any liens, restrictions, mortgages, covenants, conditions, easements, leases, or any other agreements of record or not of record, which would adversely affect Lessee's rights under this Lease; and (iii) Lessor's execution and performance of this Lease will not violate any laws, covenants or the provisions of any mortgage, lease or other agreement binding on Lessor.

38. NON-DISCRIMINATION.

Lessee and Lessor, for themselves, their successors, and assigns as a part of the consideration hereof, do hereby covenant and agree to comply with all civil rights and anti-discrimination requirements of federal, state or local laws applicable to the Property, including, without limitation, Chapter 49.60 RCW. Lessee and Lessor shall not discriminate on the basis of

race, color, marital status, national origin, religious affiliation, disability, sexual orientation, gender identity or expression or age except by minimum age and retirement provisions, unless based upon a bona fide occupational qualification, in the employment or application for employment or in the administration or delivery of services or any other benefits under King County Code Ch. 12.16.125. Lessee shall comply fully with all applicable federal, state and local laws, ordinances, executive orders and regulations that prohibit such discrimination. These laws include, but are not limited to, Chapter 49.60 RCW, and Titles VI and VII of the Civil Rights Act of 1964. Any violation of this provision shall be considered a default of this Lease and shall be grounds for cancellation, termination, or suspension, in whole or in part, of the Lease and may result in ineligibility for further agreements between the Parties.

39. MISCELLANEOUS.

A. COUNTERPARTS: This Lease may be executed in any number of counterparts, each of which, when so executed and delivered, shall be an original, but such counterparts shall together constitute but one and the same.

B. MEMORANDUM OF LEASE: Lessor agrees to sign a short form Memorandum of Lease that Lessee may record at Lessee's expense.

C. LIMITATION OF LIABILITY. Except for the indemnity obligations set forth in this Lease, and otherwise notwithstanding anything to the contrary contained in this Lease, Lessee and Tribe each waives any claims that each may have against the other with respect to consequential, incidental or special damages, however caused, based on any theory of liability.

[SIGNATURES ON FOLLOWING PAGE]

LESSOR: Suquamish Tribe of the Port Madison Indian Reservation

Leonard Forsman
By: Leonard Forsman

Its: Chairman

Date: August 29, 2016

STATE OF WASHINGTON)
) ss.
COUNTY OF KITSAP)

On this 29th day of August, 2016, before me personally appeared Leonard Forsman who acknowledged that he has authority to execute this instrument and acknowledged it as the Chairman of the Suquamish Tribe of the Port Madison Indian Reservation to be the free and voluntary act of such party for the uses and purposes mentioned in the instrument.

In witness whereof I have hereunto set my hand and affixed my official seal the day and year first above written.



Meg Daly
Meg Daly
Notary Public in and for the State of Washington
Residing at Suquamish
My commission expires 2/9/2020

APPROVED:

Secretary of the Interior

Date

Approved pursuant to 209 DM 8, 230 DM 1,3 IAM 4, 4A

EXHIBIT A

Indianola Forest and Cell Tower Site
Legal Description

A portion of the Southwest quarter of the Northwest quarter of Section 11, Township 26 North, Range 2 East, W.M., Kitsap County, Washington, described as follows:

Beginning at the Northwest corner of said Section 11;
Thence along the North line of said Section 11, South 88° 27' 12" East 666.36 feet;
Thence South 01° 21' 38" West 2037.49 feet to the Southeast corner of the Northwest quarter of said Southwest quarter of the Northwest quarter of Section 11 and the True Point of Beginning;
Thence along the East line of said subdivision, North 01° 21' 38" East 67.11 feet;
Thence South 88° 38' 22" East 136.21 feet;
Thence South 01° 21' 38" West 452.97 feet;
Thence North 88° 38' 22" West 421.39 feet;
Thence North 01° 21' 38" East 383.68 feet to a point on the South line of said Northwest quarter of the Southwest quarter of the Northwest quarter of Section 11;
Thence along said South line South 89° 04' 37" East 285.19 feet to the True Point of Beginning.

EXHIBIT B

Construction Diagrams

SHEET INDEX

ARCHITECTURAL
 T-1 TITLE SHEET
 SP-1 GENERAL NOTES
 SP-2 SPECIAL INSPECTIONS
 C-1.0 CIVIL SURVEY
 C-1.1 CIVIL SURVEY
 A-1 ADJACENT PARCEL & ZONING
 A-2 OVERALL EXISTING SITE PLAN
 A-3 ENLARGED PROPOSED SITE PLAN
 A-4 ANTENNA PLAN
 A-5.0 SOUTH ELEVATIONS
 A-5.1 NORTH ELEVATIONS
 A-5.2 DETAILS
 A-6 EQUIPMENT SHELTER PLAN AND ELEVATIONS
 A-7 FUEL TANK DETAIL AND SIGNAGE

CIVIL
 C1.1 COVER SHEET AND GENERAL NOTES
 C2.1 TEMPORARY EROSION CONTROL PLAN
 C2.2 TEMPORARY EROSION CONTROL DETAILS
 C3.1 GRADING AND DRAINAGE PLAN

STRUCTURAL
 FT.1 BUILDING AND FUEL TANK FOUNDATIONS STRUCTURAL NOTES
 FT.2 BUILDING AND TANK FOUNDATION PLANS AND DETAILS

MECHANICAL
 MT.0 MECHANICAL PLAN

ELECTRICAL
 E-1 ELECTRICAL ONE LINE DIAGRAM
 E-2 ELECTRICAL SITE PLAN
 E-3 GROUNDING PLAN & NOTES
 E-4 ANTENNA GROUNDING PLANS & NOTES
 E-5 GROUNDING DETAILS & NOTES

REGULATORY STATE FEES COMPLIANCE
 2012 RCW STANDARDS AND AMENDMENTS, WAC 61-60
 2012 IAC STANDARDS AND AMENDMENTS, WAC 31-62
 2012 ITC STANDARDS AND AMENDMENTS, WAC 51-64
 2012 UPC STANDARDS AND AMENDMENTS, WAC 61-66, 61-67
 2014 NEC STANDARDS AND AMENDMENTS, NEC 285-488

PROJECT SUMMARY

DESIGN PARTNER KING COUNTY DEPARTMENT OF INFORMATION TECHNOLOGY (KIT) 401 5TH AVENUE, 8TH FLOOR SEATTLE, WA 98101 CONTACT: JIM PHILLIPS PHONE: 206-320-3200 FAX: 206-320-3200 EMAIL: jim.phillips@kingcounty.gov	CLIENT OFFICER SUQUAMISH COMMUNITY DEVELOPMENT 22063 DEWBERRY RD. NE INDIANOLA, WA 98342 CONTACT: DAN COPE PHONE: 425-240-4300 FAX: 425-240-4300 EMAIL: dan@suquamish.com
DESIGN PARTNER KING COUNTY DEPARTMENT OF INFORMATION TECHNOLOGY (KIT) 401 5TH AVENUE, 8TH FLOOR SEATTLE, WA 98101 CONTACT: JIM PHILLIPS PHONE: 206-320-3200 FAX: 206-320-3200 EMAIL: jim.phillips@kingcounty.gov	CLIENT OFFICER SUQUAMISH COMMUNITY DEVELOPMENT 22063 DEWBERRY RD. NE INDIANOLA, WA 98342 CONTACT: DAN COPE PHONE: 425-240-4300 FAX: 425-240-4300 EMAIL: dan@suquamish.com

SITE NAME: SUQUAMISH
SITE ADDRESS: 22063 DEWBERRY RD. NE INDIANOLA, WA 98342
LAND OWNERS: UNITED STATES IN TRUST FOR THE SUQUAMISH TRIBE OF INDIANS P.O. BOX 460 SUQUAMISH, WA 98342
JURISDICTION: UNINCORPORATED KING COUNTY
PARCEL NUMBER: 118508-2-007-0000
PAPER SIZE: 31.23 ACRES
ZONING: T (TRIBAL LAND)
COMPANY: U (UNOCCUPIED)
CONSTRUCTION TYPE: V-B
PROJECT AREA: 4,250.38 SQ. FT.
NEAR NEIGHBORHOOD SURFACES: 1,889.80 SQ. FT.
EXISTING PRESERVATION:
 (THE SCOPE OF WORK INCLUDES) KING COUNTY PROJECT SUQUAMISH EMERGENCY RADIO NETWORK (PSERN) CO-LOCATION ON AN EXISTING 400' GUYED TOWER AND ASSOCIATED EQUIPMENT TO PROVIDE EMERGENCY RADIO COMMUNICATIONS TO REACH AND COORDINATE WITH EMERGENCY RESPONDERS.

PUGET SOUND EMERGENCY RADIO NETWORK

(NEW BUILD)

SUQUAMISH
 22063 DEWBERRY RD. NE
 INDIANOLA, WA 98342

LATITUDE: 47°45'35.17" N (NAD 83)
 LONGITUDE: 122°31'03.46" W (NAD 83)
 GROUND ELEVATION: 309.36' (NAVD 88)

CONFIDENTIAL AND PROPRIETARY

SIGNATURE BLOCK

TITLE	SIGNATURE	DATE
CONSTRUCTION MANAGER		
RF ENGINEER		
REAL ESTATE		
SITE ACQUISITION		
PROPERTY OWNER		
TOWER OWNER		

AREA MAP

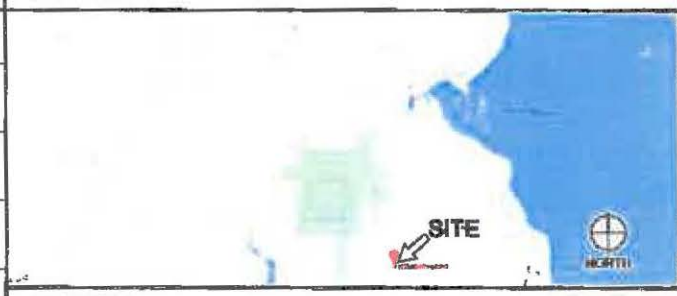

FRANCIS DIRECTIONS:
 1) HEAD SOUTHBOUND ON 5TH AVE TOWARD DEWBERRY ST. [198 FT.] 2) TURN RIGHT AT THE 1ST CROSS STREET ONTO DEWBERRY ST. [1354 FT.] 3) TURN RIGHT ONTO TUCKER HWY [2.5 MI.] 4) TURN RIGHT ONTO WESTERN AVE. [245 FT.] 5) TURN LEFT ONTO COLLETTA ST. [243 FT.] 6) TURN LEFT ONTO ALABAMA HWY 5 [340 FT.] 7) TURN RIGHT AT THE 1ST CROSS STREET ONTO SEATTLE FERRY TRAIL [628 FT.] 8) CONTINUE STRAIGHT TO STAY ON SEATTLE FERRY TRAIL [0.1 MI.] 9) TURN RIGHT [107 FT.] 10) TAKE THE SEATTLE - BANGOR ISLAND FERRY TO BANGOR ISLAND [24 FOL. - 15.9 MI.] 11) TAKE WA-206 N. WILSON HWY RD. NE AND INDIANOLA RD. NE TO DEWBERRY RD. NE IN INDIANOLA 12) CONTINUE ONTO WA-206 N. WILSON HWY RD. NE [7.9 MI.] 13) TURN RIGHT ONTO SUQUAMISH HWY RT [1.6 MI.] 14) SUQUAMISH HWY RT TURN SLIGHTLY LEFT AND CROSS AUGUSTA AVE. NE [0.6 MI.] 15) CONTINUE TOWARD SELBY HWY RD. NE [2.8 MI.] 16) TURN RIGHT ONTO INDIANOLA RD. NE [2.7 MI.] 17) TURN LEFT AT KINGSTON RD. NE [0.1 MI.] 18) CONTINUE ONTO KINGSTON RD. NE [2.8 MI.] 19) TURN RIGHT ONTO DEWBERRY RD. NE [2.1 MI.] 20) TURN LEFT TO STAY ON DEWBERRY RD. NE [APPROX. 400 FT.] 21) TURN RIGHT ON DEWBERRY RD. NE UNTIL YOU REACH THE SITE.

King County
PSERN
SUQUAMISH
 (NEW BUILD)
 22063 DEWBERRY RD. NE INDIANOLA, WA 98342

PROJECT MANAGER: SAC
PREPARED BY: LJS
APPROVED BY: PH

08/25/15 DRAWS FOR BIDDING
 08/27/15 DRAWS FOR PERMIT
 09/09/15 DRAWS FOR BIDDING
 09/24/15 DRAWS FOR PERMIT
 10/27/15 DRAWS FOR BIDDING

PLAN REVIEWING SIGNATURE

ARCHITECT'S STAMP

SHEET NAME
TITLE SHEET

SHEET NUMBER
T-1

 King County	 PERSERIN	SUQUAMISH NEW SALUDY	THESE DRAWINGS ARE TO BE SIGNED BY THE ARCHITECT	 Professional Engineer	 CART COMMUNITY AND RESIDENTS TELEPHONE: 360-885-3333 WWW.CART-OR.WA.GOV	PROJECT NUMBER: 02 DATE: 01/11/07	PREPARED BY: LM	APPROVED BY: PH	SCALE: AS SHOWN DATE: 01/11/07 DATE: 01/11/07 DATE: 01/11/07 DATE: 01/11/07	PLAN NUMBERING CONVENTION	ARCHITECT'S STAMP	SHEET NAME: ADJACENT PARCEL & ZONING	SHEET NUMBER: A-1
---	--	--------------------------------	---	--	--	---	------------------------	------------------------	---	----------------------------------	--------------------------	--	------------------------------------

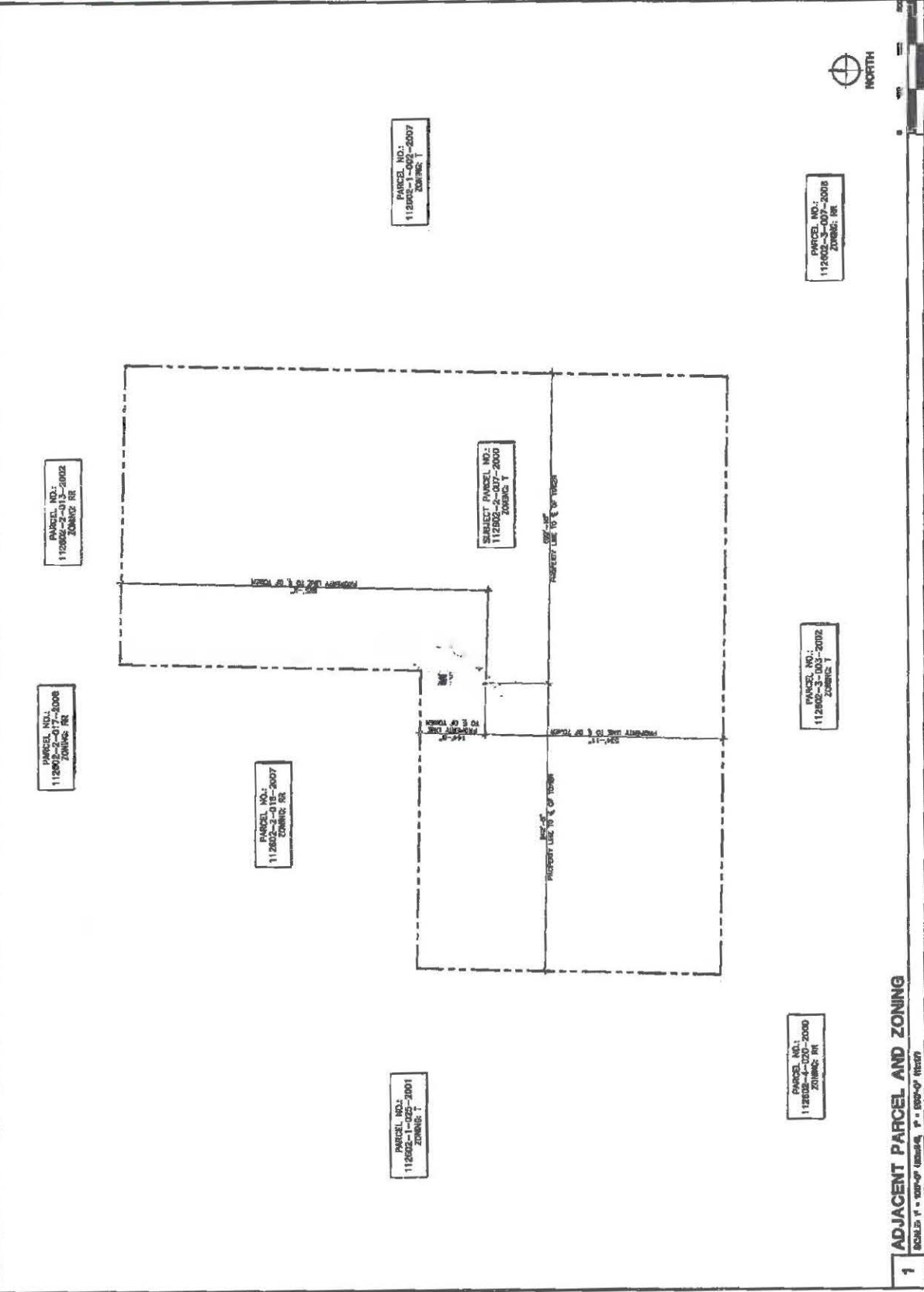

PARCEL NO.:
112802-2-017-2002
ZONING: RR

PARCEL NO.:
112802-2-017-2008
ZONING: RR

PARCEL NO.:
112802-2-007
ZONING: RR

PARCEL NO.:
112802-2-001
ZONING: T

PARCEL NO.:
112802-2-007
ZONING: T

SUBJECT PARCEL NO.:
112802-2-000
ZONING: T

PARCEL NO.:
112802-2-000
ZONING: RR

PARCEL NO.:
112802-2-013-2002
ZONING: RR

PARCEL NO.:
112802-2-007-2008
ZONING: RR

1 ADJACENT PARCEL AND ZONING
SCALE: 1" = 500'-0" (MINIMUM), 1" = 800'-0" (MAX)



SUQUAMISH
(NEW BUILD)
5000 SUQUAMISH BLVD. SE
SUQUAMISH, WA 98285



PROJECT MANAGER: SC

PREPARED BY: LM

APPROVED BY: PN

ANALYST (BASED FOR SHEET)

ANALYST (BASED FOR SHEET)

ANALYST (BASED FOR SHEET)

ANALYST (BASED FOR SHEET)

ANALYST (BASED FOR SHEET)

ANALYST (BASED FOR SHEET)

ANALYST (BASED FOR SHEET)

ARCHITECT'S STAMP

SHEET TAGS
OVERALL EXISTING SITE PLAN
SHEET NUMBER
A-2

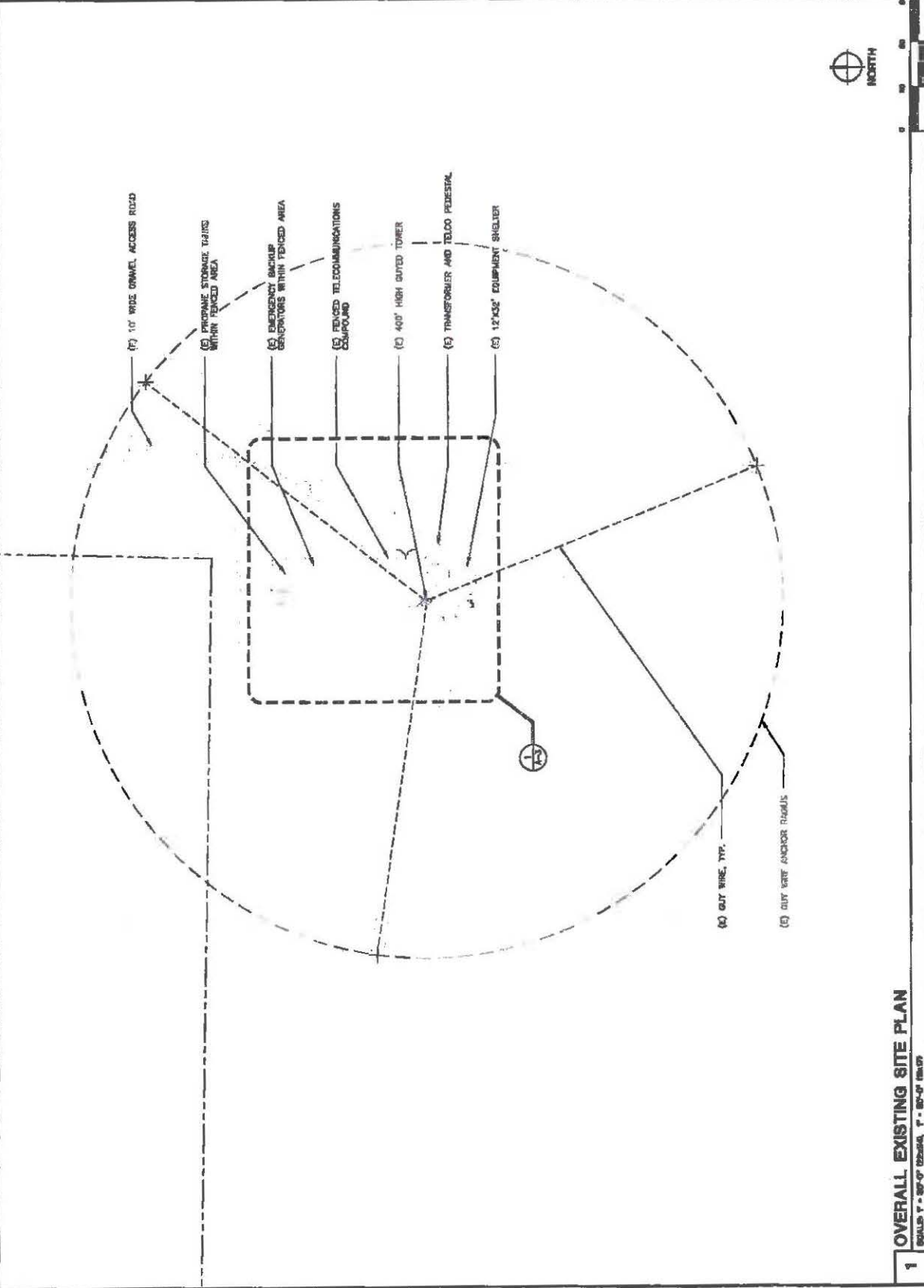

1 OVERALL EXISTING SITE PLAN
SCALE: 1" = 50'-0" EXHIBIT 1 - 50'-0" (8/17)

(C) BOLLARDS, TYP.

(E) PAD MOUNTED PROPANE STORAGE TANKS WITHIN FENCED AREA, TYP.

(E) EMERGENCY BACKUP GENERATORS WITHIN FENCED AREA

LOT 182E1 31.25 ACRES
PROJECT AREA: 4,280.38 SQ. FT.
SUPERVISOR AREA: 1,884.50 SQ. FT.

INDICATOR
CORRECTION

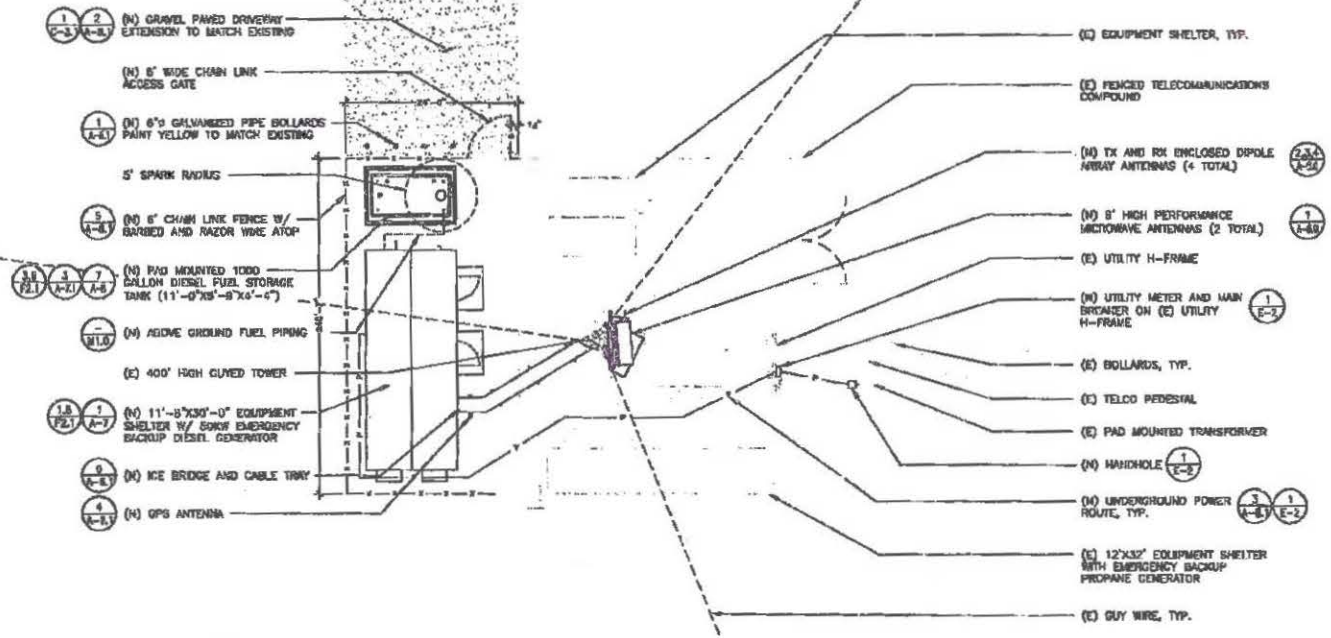

SUQUAMISH
(NEW BUILD)
2820 HANBERRY DR. SE
SUQUAMISH, WA 98285



PROJECT MANAGER: EJC
 PREPARED BY: LW
 APPROVED BY: PH

10/10/10	DESIGN FOR PERMITS
04/17/10	DESIGN FOR REVIEW
03/16/10	DESIGN FOR REVIEW
02/24/10	DESIGN FOR REVIEW
01/27/10	DESIGN FOR REVIEW

PLAN REVIEWER SIGNATURE

ARCHITECT'S STAMP

SHEET NAME
ENLARGED PROPOSED SITE PLAN

SHEET NUMBER
A-3

1 ENLARGED PROPOSED SITE PLAN
SCALE: 1/8" = 1'-0" GENERAL, 1/4" = 1'-0" DETAILS



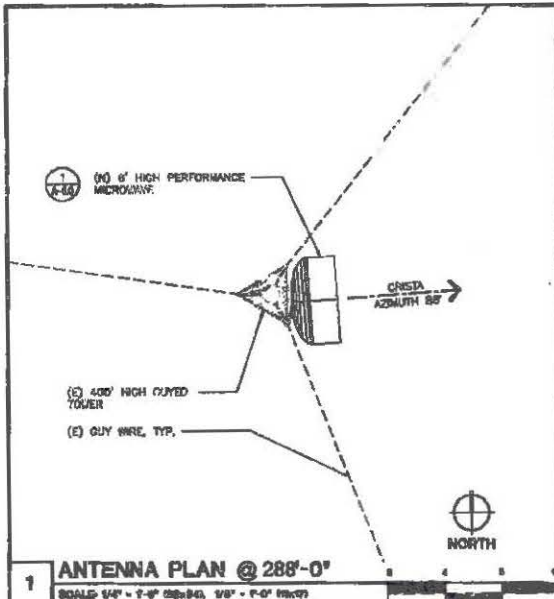

ANTENNA / COAX SCHEDULE								
W/O OWNER	F.T/E	W/OWNER HEIGHT	ASSETS	TOWER LID	QTY.	DESCRIPTION	CODE	COAX LENGTH
288'-0"	CRSDA	--	67	SC	1	6' HIGH PERFORMANCE MICROARRAY ANTENNA	EX22	4512'
240'-0"	NORTHEAST	--	117	SC	1	6' HIGH PERFORMANCE MICROARRAY ANTENNA	EX23	4272'
--	--	147'-0"	57	E FACE	1	8'-0" ENCLOSED DIPOLE ARRAY RX ANTENNA	AW3-S02A	4170'
--	--	147'-0"	75	E FACE	1	8'-0" ENCLOSED DIPOLE ARRAY RX ANTENNA	AW3-S02B	4170'
--	--	137'-0"	57	E FACE	1	8'-0" ENCLOSED DIPOLE ARRAY TX ANTENNA	AW3-S03A	4130'
--	--	137'-0"	75	E FACE	1	8'-0" ENCLOSED DIPOLE ARRAY TX ANTENNA	AW3-S03B	4130'

NOTE:
 PARTICE (1) RUN, VERIFY WHEN TOP AMPLIFIER SYSTEM.
 HEIGHT SHALL INCLUDE (1) 600' TOWER TOP AMPLIFIER 6750.
 (4) 7/8" COAXIAL CABLE (8 CABLES ARE ALLOWED FROM THE TX 13 ANTENNAS).
 (1) 1/2" COAXIAL CABLE (834-842).

- GENERAL NOTES**
- VERIFY EACH COAXIAL CABLE LENGTH, DIAMETER, INSULATION, AND ALL MOUNTING APPURTENANCES WITH OWNER PRIOR TO ORDER.
 - THE MAXIMUM COAXIAL CABLE LENGTH HAS BEEN DETERMINED BY THE TABLE ABOVE. THIS CABLE LENGTH IS APPROXIMATE AND IS TO BE USED FOR CONSTRUCTION. ACTUAL ANTENNA CABLE LENGTHS MAY VARY FROM DETERMINED MAXIMUM LENGTH AND MUST BE NOTIFIED.
 - THE ALL MAIN CABLES AT THREE (3) LOCATIONS:
 A - ANTENNAS
 B - INVERTING DISH POINT
 C - TOWERWORK CORNER
 - EACH CORN SHALL BE ORIGINATED AT (3) THREE LOCATIONS: ANTENNA, TOWER BASE AND BUILDING ENTRY POINT.

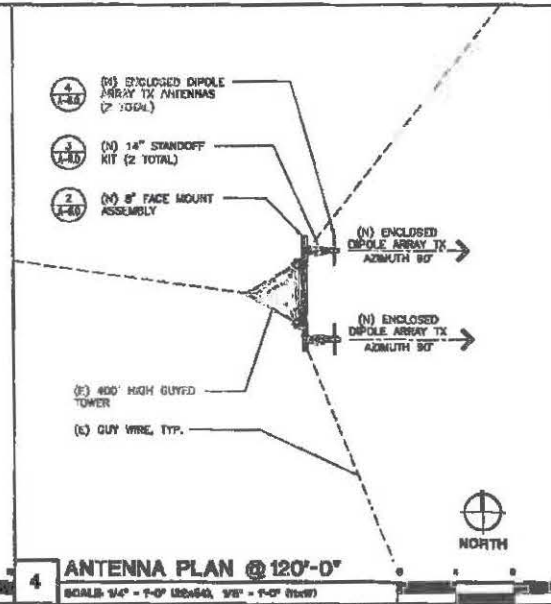
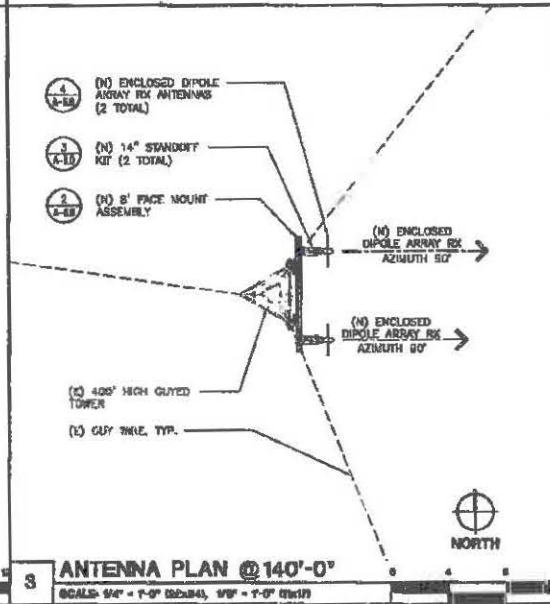
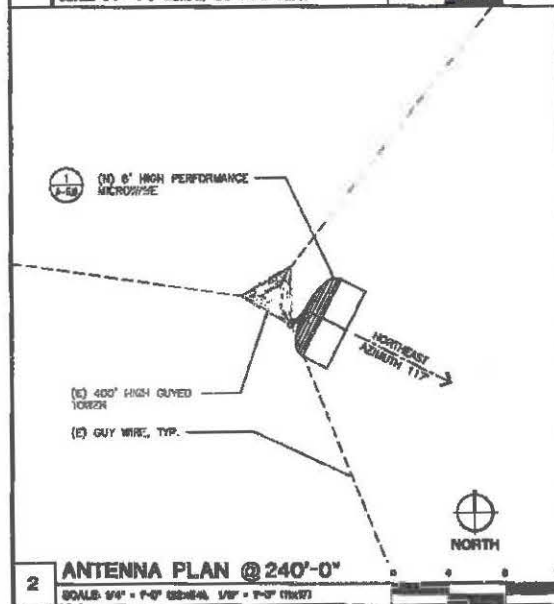

SUQUAMISH

(NEW BUILD)

3000 UNIVERSITY BL. NE
 WEDDULA WA 98048

Public Engagement

800 674 4464, 360 885 2000
 10000 1st Ave. SE
 Everett WA 98203
 PH: 425 343 2200
 WWW.SUQA.WA.GOV

CAMP+

ASSOCIATES

1000 42ND AVE. SE SUITE 100
 LYNNWOOD, WA 98036
 PH: 425 343 2200
 WWW.CAMPPLUS.COM

PROJECT MANAGER: BR

PREPARED BY: LH

APPROVED BY: PH

12/25/10 BRND FOR REVIEW
 01/17/11 BRND FOR REVIEW
 02/09/11 BRND FOR REVIEW
 02/24/11 BRND FOR REVIEW
 03/02/11 BRND FOR REVIEW

PLAN REVIEWER SIGNATURE

ARCHITECT'S STAMP

SHEET NAME

ANTENNA PLAN

SHEET NUMBER

A-4

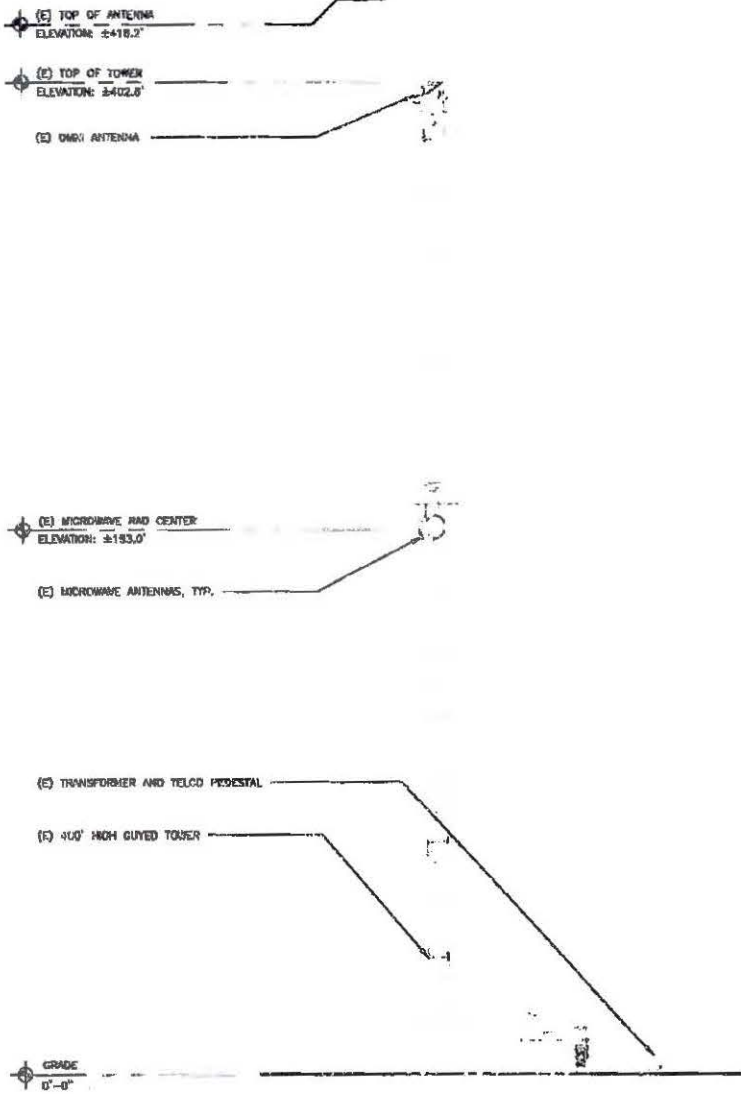

1 EXISTING SOUTH ELEVATION
SCALE: 1" = 20'-0" (25x24), 1" = 30'-0" (36x30)

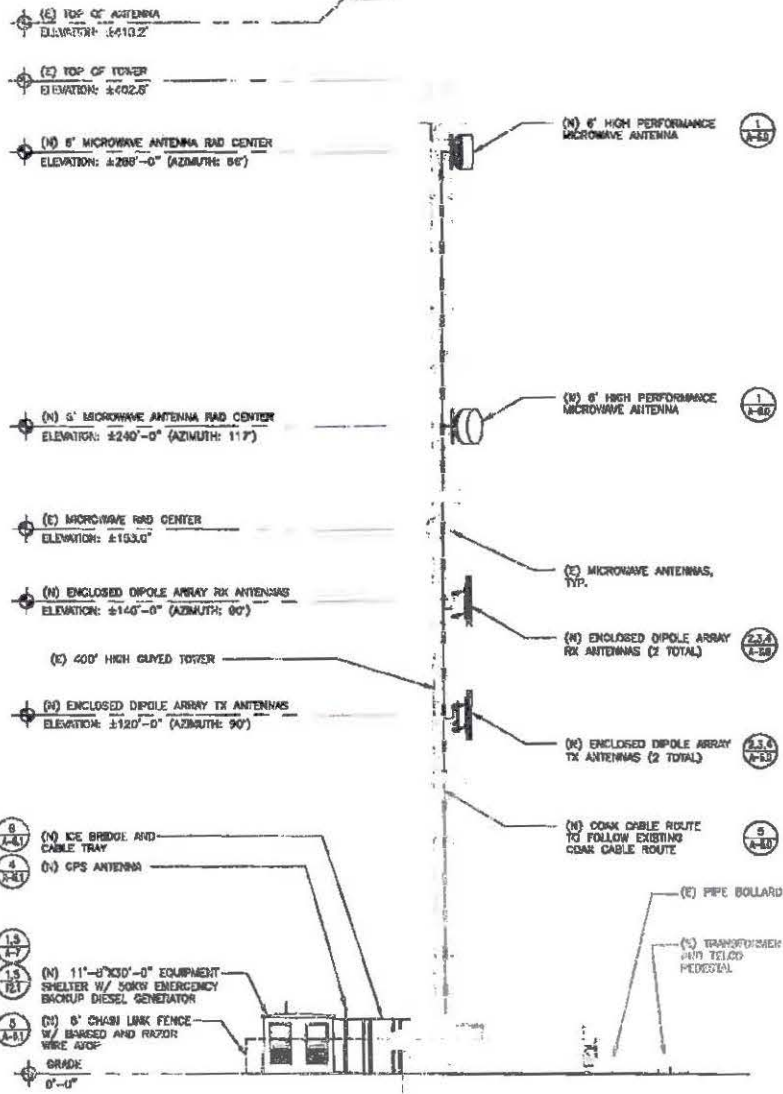

2 PROPOSED SOUTH ELEVATION
SCALE: 1" = 20'-0" (25x24), 1" = 30'-0" (36x30)

King County

WSPERR

SUQUAMISH
(NEW BUILD)
6300 DORSEY RD, SE
SPRANGLA, WA 98083

BUQUAMISH
Project Description

CAMP+
ARCHITECTS
1001 4TH AVENUE, SUITE 200
SEATTLE, WA 98101
PHONE: 206.465.2000
FAX: 206.465.2000
WWW.CAMPARCHITECTS.COM

PROJECT MANAGER: EJC

PREPARED BY: LJE

APPROVED BY: JN

10/20/10	ISSUED FOR PERMIT
08/17/10	ISSUED FOR BIDDING
02/26/10	ISSUED FOR BIDDING
08/26/10	ISSUED FOR BIDDING
05/19/10	ISSUED FOR BIDDING

PLAN REVISIONS SIGNATURE

ARCHITECT'S STAMP

SHEET NAME
SOUTH ELEVATIONS

SHEET NUMBER
A-5.0

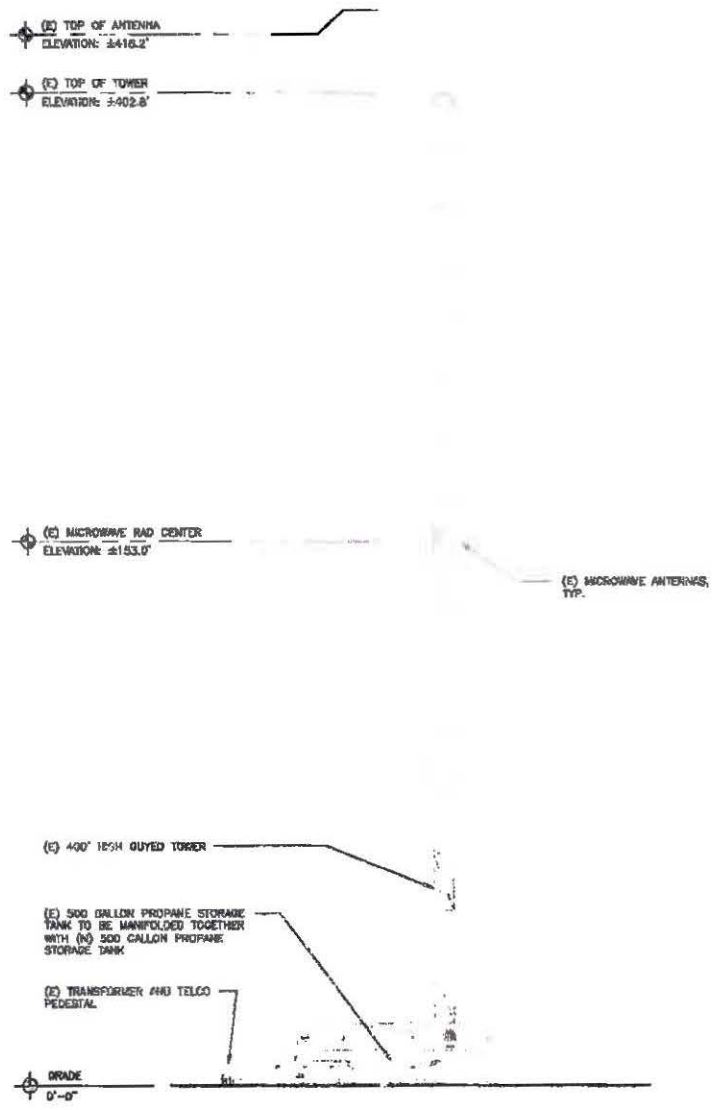

1 EXISTING NORTH ELEVATION

SCALE: 1" = 10'-0" (SEE 04), 1" = 20'-0" (SEE 07)

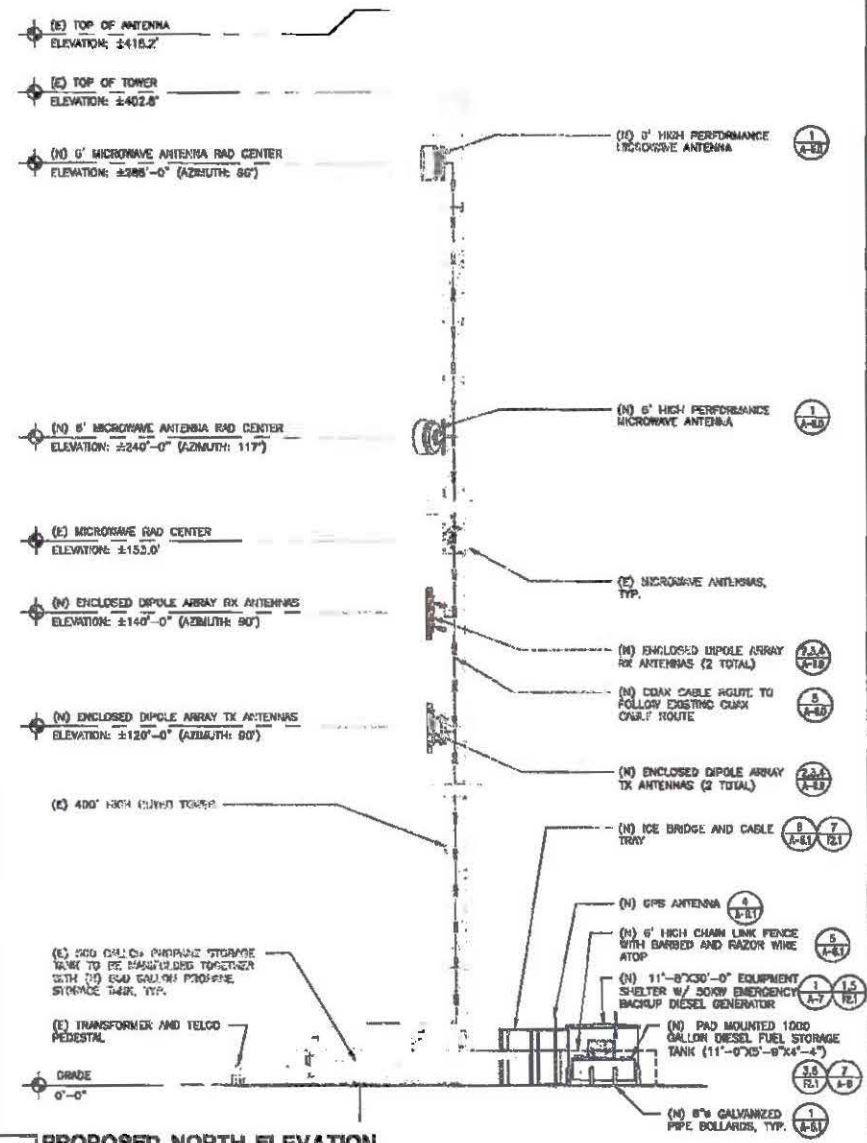

2 PROPOSED NORTH ELEVATION

SCALE: 1" = 10'-0" (SEE 04), 1" = 20'-0" (SEE 07)



King County



SUQUAMISH

(NEW BUILD)

ISSUED PERMIT FOR THE
SQUAMISH, TEL. 855-42



City of Squamish

2000 BAYVIEW BL. SUITE 200
SQUAMISH, BC V8B 0G9
PHONE: 604-938-2222
WWW.CITYOFSQUAMISH.BC.CA



CASEP
CONSULTING ENGINEERS

1000 10TH AVE. SUITE 100
LYNDEN, WA 98295
PHONE: 360-735-7888
FAX: 360-735-7889
WWW.CASEP-ENG.COM

PROJECT MANAGER: **CM**

PREPARED BY: **LM**

APPROVED BY: **PM**

10/22/10	ISSUED FOR PERMIT
11/17/10	ISSUED FOR REVIEW
11/23/10	ISSUED FOR REVIEW
02/26/11	ISSUED FOR REVIEW
05/24/11	ISSUED FOR REVIEW
09/14/11	ISSUED FOR REVIEW

PLANS REVIEWER'S SIGNATURE

ARCHITECT'S STAMP

SHEET NAME
NORTH ELEVATIONS

SHEET NUMBER
A-5.1

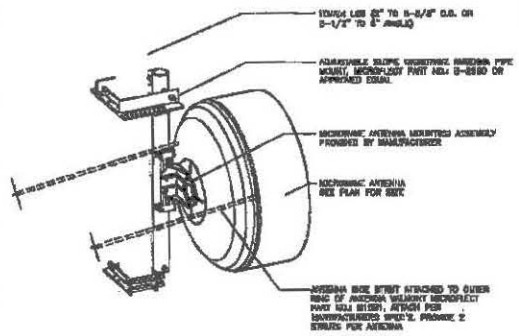

NOTE: CONDENSER TO INSTALL HORIZONTAL SUPPORT AS REQUIRED.

1 MW ANTENNA MOUNT ASSEMBLY
NOT TO SCALE

ITEM	QTY	PART NO.	DESCRIPTION	LENGTH	UNIT	NET WT.
1	1	1000000000	1/2" DIA. GALV. STEEL PIPE	10	FT.	10.0
2	1	1000000000	1/2" DIA. GALV. STEEL PIPE	10	FT.	10.0
3	1	1000000000	1/2" DIA. GALV. STEEL PIPE	10	FT.	10.0
4	1	1000000000	1/2" DIA. GALV. STEEL PIPE	10	FT.	10.0
5	1	1000000000	1/2" DIA. GALV. STEEL PIPE	10	FT.	10.0
6	1	1000000000	1/2" DIA. GALV. STEEL PIPE	10	FT.	10.0
7	1	1000000000	1/2" DIA. GALV. STEEL PIPE	10	FT.	10.0
8	1	1000000000	1/2" DIA. GALV. STEEL PIPE	10	FT.	10.0
9	1	1000000000	1/2" DIA. GALV. STEEL PIPE	10	FT.	10.0
10	1	1000000000	1/2" DIA. GALV. STEEL PIPE	10	FT.	10.0

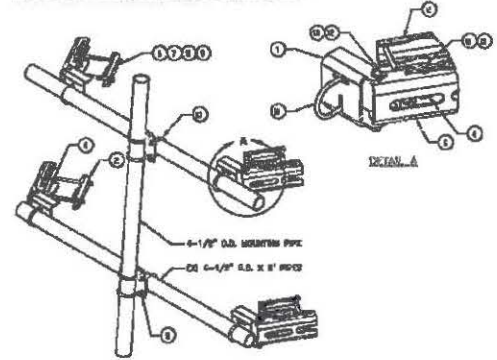

COMMSCOPE TT-14-2

2 TOWER FACE MOUNT ASSEMBLY
KEY TO SCALE

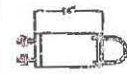

ITEM	QTY	PART NO.	DESCRIPTION	LENGTH	UNIT	NET WT.
1	1	1000000000	1/2" DIA. GALV. STEEL PIPE	10	FT.	10.0
2	1	1000000000	1/2" DIA. GALV. STEEL PIPE	10	FT.	10.0
3	1	1000000000	1/2" DIA. GALV. STEEL PIPE	10	FT.	10.0
4	1	1000000000	1/2" DIA. GALV. STEEL PIPE	10	FT.	10.0
5	1	1000000000	1/2" DIA. GALV. STEEL PIPE	10	FT.	10.0
6	1	1000000000	1/2" DIA. GALV. STEEL PIPE	10	FT.	10.0
7	1	1000000000	1/2" DIA. GALV. STEEL PIPE	10	FT.	10.0
8	1	1000000000	1/2" DIA. GALV. STEEL PIPE	10	FT.	10.0
9	1	1000000000	1/2" DIA. GALV. STEEL PIPE	10	FT.	10.0
10	1	1000000000	1/2" DIA. GALV. STEEL PIPE	10	FT.	10.0

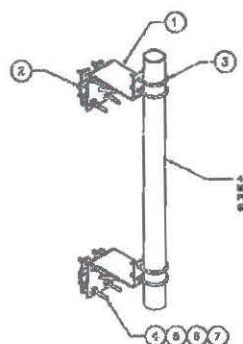

COMMSCOPE TT-ST

3 TOWER FACE MOUNT 14' STAND OFF
NOT TO SCALE

ITEM	QTY	PART NO.	DESCRIPTION	LENGTH	UNIT	NET WT.
1	1	1000000000	1/2" DIA. GALV. STEEL PIPE	10	FT.	10.0
2	1	1000000000	1/2" DIA. GALV. STEEL PIPE	10	FT.	10.0
3	1	1000000000	1/2" DIA. GALV. STEEL PIPE	10	FT.	10.0
4	1	1000000000	1/2" DIA. GALV. STEEL PIPE	10	FT.	10.0
5	1	1000000000	1/2" DIA. GALV. STEEL PIPE	10	FT.	10.0
6	1	1000000000	1/2" DIA. GALV. STEEL PIPE	10	FT.	10.0
7	1	1000000000	1/2" DIA. GALV. STEEL PIPE	10	FT.	10.0
8	1	1000000000	1/2" DIA. GALV. STEEL PIPE	10	FT.	10.0
9	1	1000000000	1/2" DIA. GALV. STEEL PIPE	10	FT.	10.0
10	1	1000000000	1/2" DIA. GALV. STEEL PIPE	10	FT.	10.0

ACCURACY	"A"	QTY	"B"	THRU	"C"	LENGTH	"D"	UNIT	"E"	TOTAL WEIGHT
1	1	1	1	1	1	1	1	1	1	1

IMPORTANT NOTES:
1. PRODUCT DATA OBTAINED FROM PUBLISHED MANUFACTURER'S DATA SHEETS AND IS SUBJECT TO CHANGE. CONSULT TO VERIFY INFORMATION PRIOR TO ORDERING.
2. THIS DRAWING INCLUDES RELATED PAGES, DETAILS AND SPECIFICATIONS. IS THE EXCLUSIVE PROPERTY OF SITE PRO I LLC AND PROVIDED ONLY FOR THE PURPOSE OF SPECIFYING AND ORDERING THE PRO I PARTS ON PROFORM DRAWINGS, BIDS AND SITE PLANS. ANY OTHER USE OF THESE MATERIALS IS EXPRESSLY PROHIBITED.

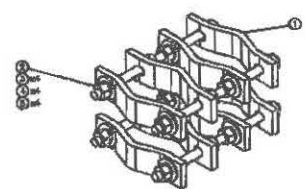
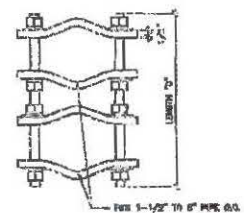

4 SITE PRO DCP12K PIPE TO PIPE CLAMP SET
NOT TO SCALE

6 CABLE ROUTING DETAIL
NOT TO SCALE



SUQUAMISH
(NEW BUILD)
2000 BERRYMAN RD. SE
SUQUAMISH, WA 98285

Planning & Engineering
1000 10TH AVE. S. SUITE 100
SUQUAMISH, WA 98285
PHONE: 360-885-4500
WWW.KCWA.COM

CAMP ASSOCIATES
1000 10TH AVE. S. SUITE 100
SUQUAMISH, WA 98285
PHONE: 360-885-4500
WWW.CAMPASSOCIATES.COM

PROJECT MANAGER: EAC
PREPARED BY: LM
APPROVED BY: PH

PLAN REVIEWING SIGNATURE

ARCHITECT'S STAMP

SHEET NAME
DETAILS

SHEET NUMBER
A-6.0

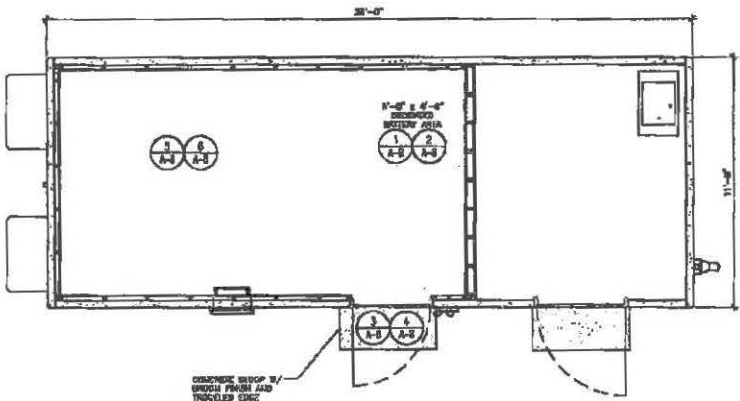

- NOTES:**
1. SHELTER IS ORDER FURNISHED, CONTRACTOR (SHELL) (S/C.A.)
 2. ALL INSTALLATIONS SHALL BE VERIFIED WITH PRELIMINARY SHELTER SHOP DRAWING PRIOR TO ANY CONSTRUCTION WORK OR DEMOLITION.
 3. REFER TO DEMO STRUCTURAL DRAWINGS FOR FOUNDATION AND DEMO FOR SHELTER ACCORDING TO FOUNDATION.
 4. CONTRACTOR TO USE EMPLOYERS WELD AT ALL WELDED JOINTS FROM TOLERANCE TO GROUND EDGE, SEE ALSO CONCRETE PLAN.

1 EQUIPMENT SHELTER PLAN
SCALE 3/8" = 1'-0" (22x34) 3/16" = 1'-0" (12x17)

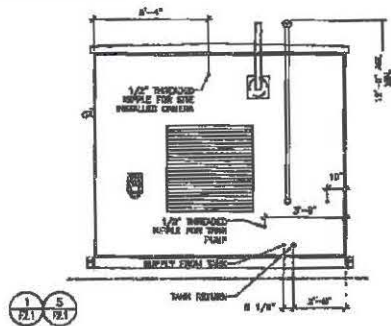

4 RIGHT ELEVATION
SCALE 3/8" = 1'-0" (22x34) 3/16" = 1'-0" (12x17)

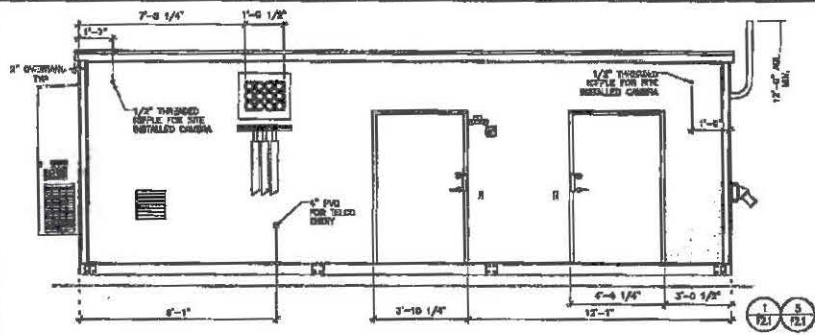

2 FRONT ELEVATION
SCALE 3/8" = 1'-0" (22x34) 3/16" = 1'-0" (12x17)

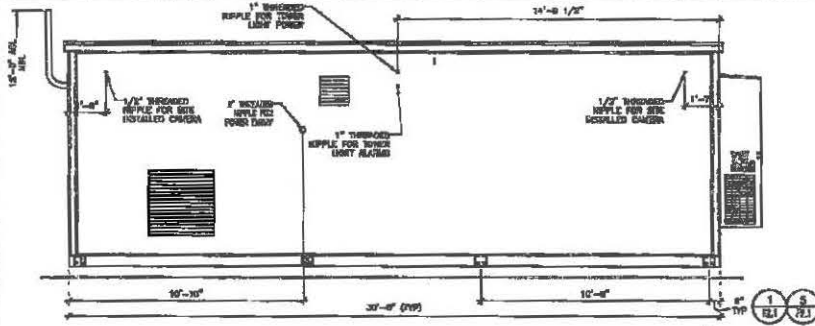

3 REAR ELEVATION
SCALE 3/8" = 1'-0" (22x34) 3/16" = 1'-0" (12x17)

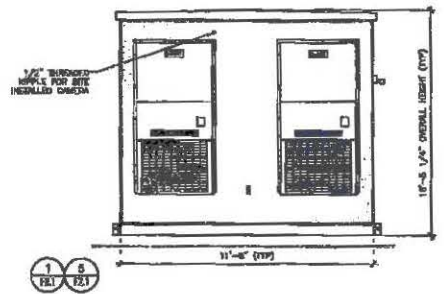

5 LEFT ELEVATION
SCALE 3/8" = 1'-0" (22x34) 3/16" = 1'-0" (12x17)

King County
INSERNO
SUQUAMISH
(NEW BUILD)
8200 CANNERY RD. SE
BRACOLA, WA 98526

PASCO ENGINEERS
680 5TH AVE. N. SUITE 200
PASCO, WA 99016
PHONE: 509.546.4500
WWW.PASCOENR.COM

CAMP ASSOCIATES
1401 ASTOR BL. SUITE 200
LYNNWOOD, WA 98037
PHONE: 425.764.6200
WWW.CAMPASSOCIATES.COM

PROJECT NUMBER: 240
PREPARED BY: LSI
APPROVED BY: PH

REVISIONS:
05/20/18 ISSUED FOR PERM
05/20/18 ISSUED FOR PERM
05/20/18 ISSUED FOR PERM
05/20/18 ISSUED FOR PERM
05/20/18 ISSUED FOR PERM

PLAN REVIEWER SIGNATURE
ARCHITECTS STAMP
SHEET NAME
EQUIPMENT SHELTER PLAN AND ELEVATIONS
SHEET NUMBER
A-7

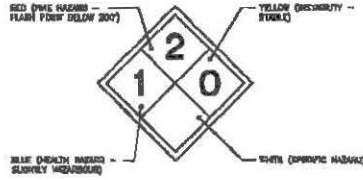

SEEK
REFUGIL FOR MANUFACTURER
SPECIFICATIONS AND FCC
GUIDELINES

Thermal Runaway Preceding Picking
 Attachment A to Thermal Runaway procedure
 Reading & handling instructions for Thermal Runaway
 A copy of this page shall be included or placed in a plastic sheet protector and posted in an
 obvious area.
 If you encounter conditions that lead to a tank fire or other emergency or activities which have the
 potential to lead to a tank fire or other emergency:
 • Do not be in a tank or near
 • If the fire starts use gas
 • If there is a strong release of hydrogen sulfide gas
 Evacuation - Take an action that will prevent a spill and leads to a tank fire or other emergency
 If you encounter conditions that lead to a tank fire or other emergency and it is not possible to
 evacuate:
 • Get low
 • Remove yourself to a safe area
 • Reduce oxygen demand by covering off enough material so that the tank is covered
 or by covering the tank with
 • Remove yourself to a safe area if possible
 • If there is a spill or other hazardous situation call the Washington Trencher at 1-800-868-7622
 Do not attempt to fight a tank fire. Evacuate unless you are specifically trained to do so. Do not
 attempt to fight a tank fire unless you are specifically trained to do so. Do not attempt to
 fight a tank fire unless you are specifically trained to do so. Do not attempt to fight a tank fire
 unless you are specifically trained to do so. Do not attempt to fight a tank fire unless you are
 specifically trained to do so. Do not attempt to fight a tank fire unless you are specifically
 trained to do so. Do not attempt to fight a tank fire unless you are specifically trained to do so.
 APPROVED: _____

8 COMBUSTIBLE LIQUIDS SIGN
NOT TO SCALE

8 HAZARDOUS MATERIAL CLASSIFICATION SIGN (DIESEL)
NOT TO SCALE

4 RF WARNING SIGN
NOT TO SCALE

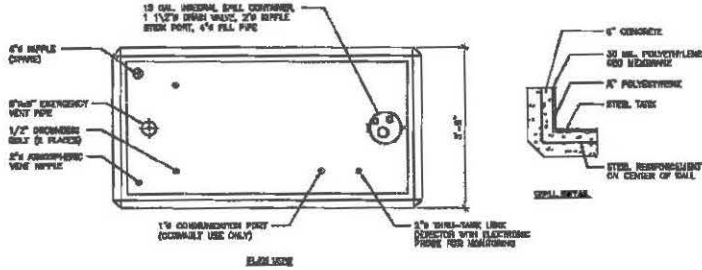
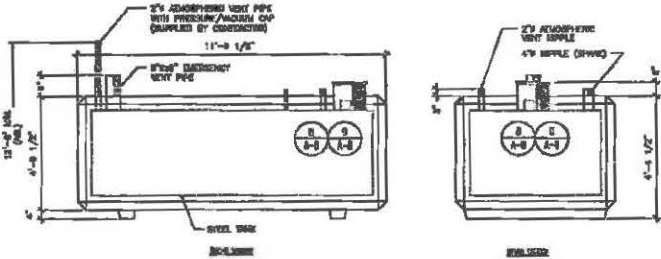

CONCRETE 1000 GAL. TANK NOTES:

1. STEEL TANK SHALL BE ULL 142 LISTED FOR ABOVE GRADE STORAGE OF FLAMMABLE LIQUIDS.
2. STEEL TANK BESS SHALL BE 3/16" THICK ASTM A-36 STEEL PLATE.
3. ALL EXPOSED METAL WITH THE EXCEPTION OF SWAGERS SHALL BE PROPER COATED TO RESIST CORROSION.
4. STEEL TANKS SHALL BE RECTANGULAR IN SHAPE AND HAVE CONTINUOUS WELDS ON THE OUTSIDE.
5. STEEL TANK AND SECONDARY CONTAINMENT SHALL BE ENCASED IN SIX INCHES OF 4000 P.S.I. REINFORCED CONCRETE.
6. STEEL TANK SHALL BE PROPERLY TESTED AT 3 P.S.I. FOR 16 HOURS WITHOUT PRESSURE DROP.
7. TANK SHALL SYSTEM SHALL BE LISTED IN ACCORDANCE WITH ULL STANDARD 142 AND SHALL BE HAVE A TWO HOUR FIRE RATING.
8. TANKS SHALL HAVE THE CAPACITY OF FURTHER MONITORING BETWEEN THE PRIMARY AND THE SECONDARY CONTAINMENT.
9. THE SECONDARY CONTAINMENT SHALL CONSIST OF A 30 GAL HIGH DENSITY POLYETHYLENE GAS MEMBRANE.
10. THE WALK SHALL BE OF A MONOLITHIC (SEAMLESS AND CONTINUOUS) CONCRETE FLOOR AND CONTAIN NO GILD JOINTS OR HEAVY
SINGS (HEAT TRANSFER POINTS) ON THE BOTTOM OR SIDES.
11. WALK SHALL HAVE COATED CONCRETE EXTERIOR TO RESIST WEAR AND REPLYCY DAMAGE.

7 CONVAULT FUEL TANK DETAIL (1000 GAL.)
NOT TO SCALE

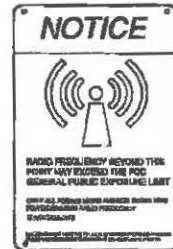

SEEK
REFUGIL FOR MANUFACTURER
SPECIFICATIONS AND FCC
GUIDELINES

6 RF WARNING SIGN
NOT TO SCALE



6 RF NOTICE SIGN
NOT TO SCALE

1 THERMAL RUNAWAY PROCEDURE
NOT TO SCALE



SEEK
REFUGIL FOR MANUFACTURER
SPECIFICATIONS &
FCC GUIDELINES

2 CORROSIVE LIQUIDS SIGN
NOT TO SCALE

IN CASE OF
EMERGENCY
CALL N.O.C.C.
1-800-264-8620

SEEK
REFUGIL FOR MANUFACTURER
SPECIFICATIONS &
FCC GUIDELINES

3 N.O.C.C. SIGN
NOT TO SCALE



SUQUAMISH
(NEW BUILD)
8000 DENVERBY RD. SE
SUQUAMISH, WA 98242



PROJECT MANAGER: SAC
 PREPARED BY: LM
 APPROVED BY: PH

02/27/10	DESIGN FOR PERMIT
03/17/10	DESIGN FOR PERMIT
03/23/10	DESIGN FOR PERMIT
05/25/10	DESIGN FOR PERMIT
05/19/10	DESIGN FOR PERMIT

PLAN REVIEWING SIGNATURE

ARCHITECT'S STAMP

SHEET NAME
FUEL TANK DETAIL & SIGNAGE

SHEET NUMBER
A-8

MISCELLANEOUS EQUIPMENT SCHEDULE

SYMBOL	ITEM DESCRIPTION	SPECIFIED MFR & MODEL NO.	AREA SERVED	EQUIPMENT CAPACITY	ELECTRICAL		REMARKS
					AMPS	VOLTS/PH	
LSP-1	TANK GAUGE AND LEAK DETECTION PANEL	FUEL SENTRY T8-EL-04A	TANK, DAY TANK	8 INPUT	-	120/1	PROVIDE NEMA 3R ENCLOSURE

PUMP SCHEDULE

SYMBOL	SPECIFIED MANUFACTURER AND SERIES NO.	TYPE	SERVICE	GPM	HEAD FT H2O	ELECTRICAL		REMARKS
						MIN. HP	VOLTS/PH	
PYP-1	TUTHILL SD8020	TRANSFER	FUEL OIL	13	8'	1/8	115/1	-

LEAK DETECTION

PROVIDE LEAK MONITORING OF THE DOUBLE-WALLED FUEL PIPING, AND THE DOUBLE-WALLED FUEL TANK.

PROVIDE LIQUID DETECTOR IN DOUBLE WALLED FUEL TANK.

PROVIDE LINE PRESSURE DETECTOR FOR DOUBLE WALLED FLEXIBLE FUEL PIPING.

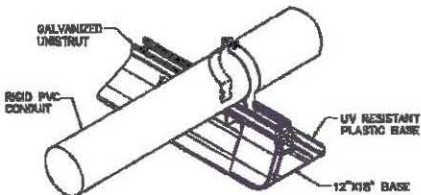

PIPE SUPPORT
NOT TO SCALE

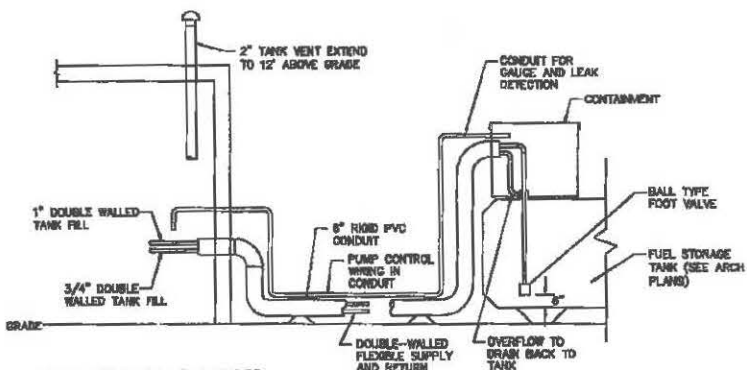

FUEL PIPING DIAGRAM
NOT TO SCALE

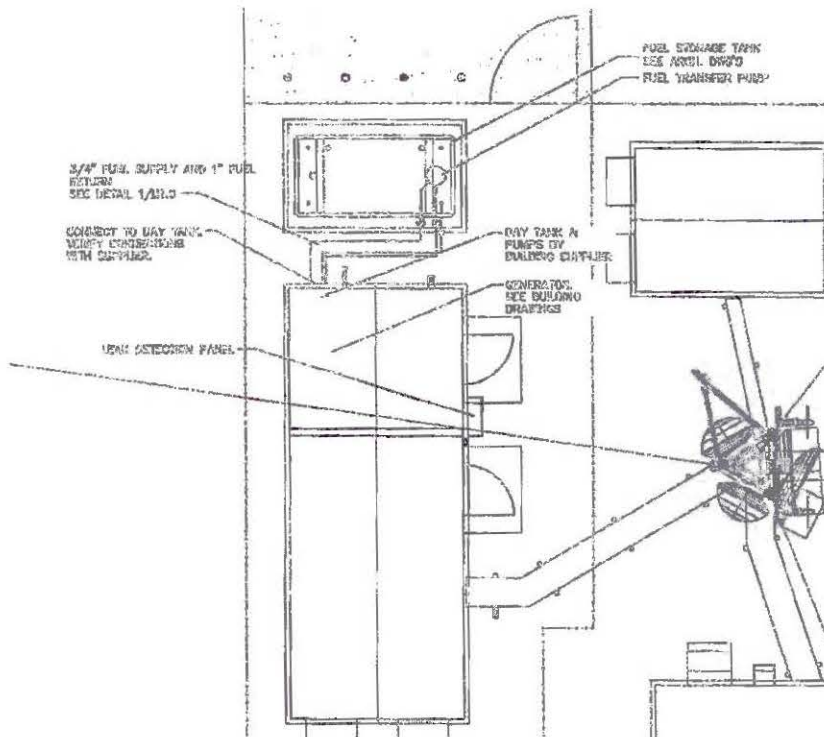

FUEL SYSTEM - SITE PLAN

SCALE: 1/4" = 1' - 0"



PRELIMINARY



SUQUAMISH
(NEW BUILD)
2283 DEWBERRY ROAD NE
HOQUIA, WA 98040



PROJECT MANAGER:
PREPARED BY: AN
APPROVED BY: TW

DATE/ISSUE

PLAN REVIEWING SIGNATURE



SHEET NAME
MECHANICAL PLAN

SHEET NUMBER
M1.0



SUQUAMISH
(AFCP FIELD)

3800 ZENITHWAY NW, SUITE 100
SUQUAMISH, WA 98285



CAMP AUTOMATION
11000 15TH AVENUE NW
SUITE 1000
LYNNWOOD, WA 98037
PH: 206.835.1234
WWW.CAMPAUTOMATION.COM

PROJECT MANAGER: GAC
PREPARED BY: LM
APPROVED BY: PH

12/21/10 ISSUED FOR PERMIT
12/21/10 ISSUED FOR PERMIT
12/21/10 ISSUED FOR PERMIT
12/21/10 ISSUED FOR PERMIT
12/21/10 ISSUED FOR PERMIT

PLAN REVIEWER'S SIGNATURE
ARCHITECT'S STAMP

SHEET NAME
**ANTENNA
GROUNDING
PLANS & NOTES**
SHEET NUMBER
E-4

GENERAL NOTES:

- ALL WORK SHALL BE IN ACCORDANCE WITH THE LATEST EDITIONS OF THE NATIONAL ELECTRICAL CODE (NEC) AND THE NATIONAL FIRE ALARM AND SIGNAL CODE (NFPA 72).
- ALL ELECTRICAL WORK SHALL BE INSTALLED IN ACCORDANCE WITH THE NATIONAL ELECTRICAL CODE (NEC) AND THE NATIONAL FIRE ALARM AND SIGNAL CODE (NFPA 72).
- ALL ELECTRICAL WORK SHALL BE INSTALLED IN ACCORDANCE WITH THE NATIONAL ELECTRICAL CODE (NEC) AND THE NATIONAL FIRE ALARM AND SIGNAL CODE (NFPA 72).
- ALL ELECTRICAL WORK SHALL BE INSTALLED IN ACCORDANCE WITH THE NATIONAL ELECTRICAL CODE (NEC) AND THE NATIONAL FIRE ALARM AND SIGNAL CODE (NFPA 72).
- ALL ELECTRICAL WORK SHALL BE INSTALLED IN ACCORDANCE WITH THE NATIONAL ELECTRICAL CODE (NEC) AND THE NATIONAL FIRE ALARM AND SIGNAL CODE (NFPA 72).
- ALL ELECTRICAL WORK SHALL BE INSTALLED IN ACCORDANCE WITH THE NATIONAL ELECTRICAL CODE (NEC) AND THE NATIONAL FIRE ALARM AND SIGNAL CODE (NFPA 72).
- ALL ELECTRICAL WORK SHALL BE INSTALLED IN ACCORDANCE WITH THE NATIONAL ELECTRICAL CODE (NEC) AND THE NATIONAL FIRE ALARM AND SIGNAL CODE (NFPA 72).
- ALL ELECTRICAL WORK SHALL BE INSTALLED IN ACCORDANCE WITH THE NATIONAL ELECTRICAL CODE (NEC) AND THE NATIONAL FIRE ALARM AND SIGNAL CODE (NFPA 72).
- ALL ELECTRICAL WORK SHALL BE INSTALLED IN ACCORDANCE WITH THE NATIONAL ELECTRICAL CODE (NEC) AND THE NATIONAL FIRE ALARM AND SIGNAL CODE (NFPA 72).
- ALL ELECTRICAL WORK SHALL BE INSTALLED IN ACCORDANCE WITH THE NATIONAL ELECTRICAL CODE (NEC) AND THE NATIONAL FIRE ALARM AND SIGNAL CODE (NFPA 72).

NOTED NOTES:

- SEE ELECTRICAL CONTRACT FOR DETAILS OF ANTENNA SYSTEM.
- SEE ELECTRICAL CONTRACT FOR DETAILS OF ANTENNA SYSTEM.
- SEE ELECTRICAL CONTRACT FOR DETAILS OF ANTENNA SYSTEM.
- SEE ELECTRICAL CONTRACT FOR DETAILS OF ANTENNA SYSTEM.
- SEE ELECTRICAL CONTRACT FOR DETAILS OF ANTENNA SYSTEM.
- SEE ELECTRICAL CONTRACT FOR DETAILS OF ANTENNA SYSTEM.
- SEE ELECTRICAL CONTRACT FOR DETAILS OF ANTENNA SYSTEM.
- SEE ELECTRICAL CONTRACT FOR DETAILS OF ANTENNA SYSTEM.
- SEE ELECTRICAL CONTRACT FOR DETAILS OF ANTENNA SYSTEM.
- SEE ELECTRICAL CONTRACT FOR DETAILS OF ANTENNA SYSTEM.

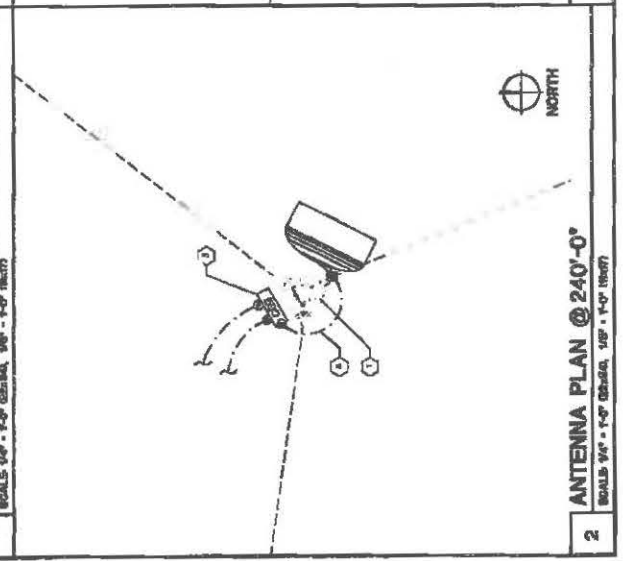
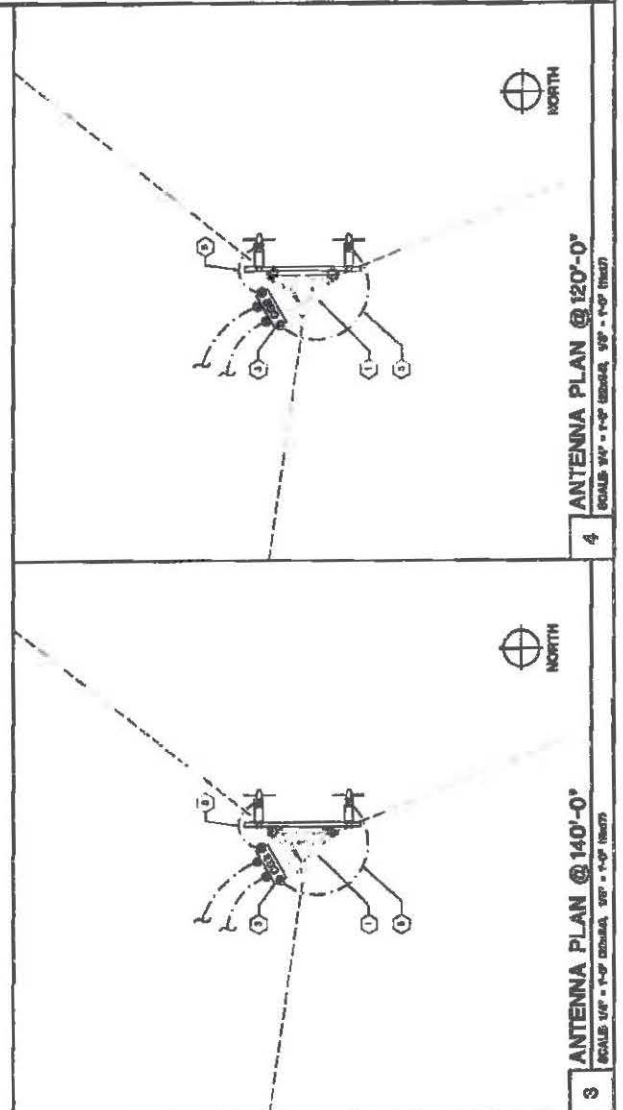
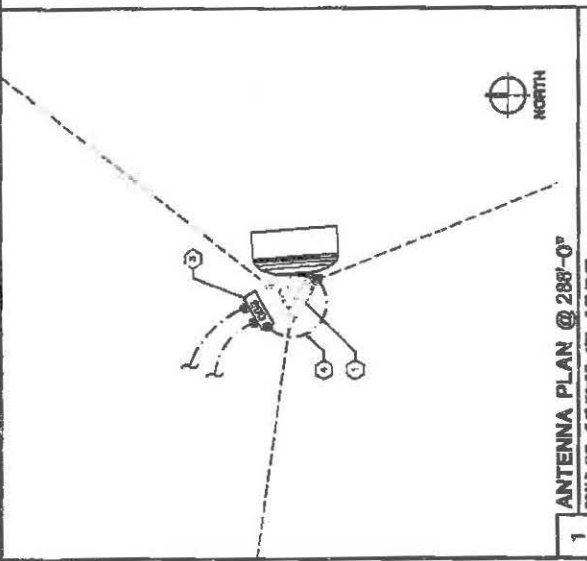

EXHIBIT C

**SUQUAMISH TOWER SITE LEASE
RATE SCHEDULE**

Description	2016	2017	2018	2019	2020	2021
Space in Building (per sq. ft.)	\$2.24	2.29	2.34	2.39	2.44	2.50
Land Space (per sq.ft.)	\$1.60	1.64	1.68	1.72	1.76	1.80
Up to 200' Antenna Height to Ground (per ft.)	0.57	0.58	0.59	0.60	0.61	0.62
Over 200' Antenna Height to Ground (per ft.)	0.83	0.85	0.87	0.89	0.91	0.93
Antennas & Sizes						
4' Enclosed Dipole Array	31.84	32.56	33.29	34.04	34.81	35.59
6' High Performance Microwave	38.31	39.17	40.05	40.95	41.87	42.81
8' Enclosed Dipole Array	44.70	45.71	46.74	47.79	48.87	49.97

NOTE: Annual increase at 2.25% each year
for each rate.

Rate Card for 2016

Antenna	Base Rate	Height	Multiplier	Ht per Mo.	Mo. Total	12 mo. Total
Tower Mounted Amplifier	24.98	140'	0.57	79.8	104.78	1257.36
4' Enclosed Dipole Array	31.84	120'	0.57	68.40	100.24	1202.88
4' Enclosed Dipole Array	31.84	120'	0.57	68.40	100.24	1202.88
6' High Performance Microwave	38.31	240'	0.83	239.04	277.35	3328.20
6' High Performance Microwave	38.31	288'	0.83	239.04	277.35	3328.20
8' Enclosed Dipole Array	44.70	140'	0.57	79.80	124.50	1494.00
8' Enclosed Dipole Array	44.70	140'	0.57	79.80	124.50	1494.00
Sub-Total Antenna					1108.96	13307.52
Leased Land Space (1083 sq. ft)	1083'		1.60		1732.80	20793.60
2016 TOTAL					\$2,841.76	\$34,101.12