

# **ATTACHMENT A: 295C0220\_scs**

**AGREEMENT  
BETWEEN  
KING COUNTY  
AND**

**KING COUNTY CORRECTIONS GUILD  
DEPARTMENT OF ADULT AND JUVENILE DETENTION**

1  
2  
3  
4  
5  
6  
7  
8  
9  
10  
11  
12  
13  
14  
15  
16  
17  
18  
19  
20  
21  
22  
23  
24  
25  
26  
27  
28

ARTICLE 1:	POLICY AND PURPOSE.....	1
ARTICLE 2:	GUILD RECOGNITION AND MEMBERSHIP .....	2
ARTICLE 3:	MANAGEMENT RIGHTS .....	4
ARTICLE 4:	GUILD REPRESENTATION.....	6
ARTICLE 5:	HOLIDAYS.....	10
ARTICLE 6:	VACATION .....	12
ARTICLE 7:	SICK LEAVE .....	17
ARTICLE 8:	WAGE RATES.....	25
ARTICLE 9:	OVERTIME AND DEFINITIONS .....	27
ARTICLE 10:	HOURS OF WORK .....	36
ARTICLE 11:	MEDICAL, DENTAL, AND LIFE INSURANCE PROGRAMS .....	39
ARTICLE 12:	MISCELLANEOUS .....	40
ARTICLE 13:	GRIEVANCE PROCEDURE .....	46
ARTICLE 14:	FURLOUGH AND SHIFT ASSIGNMENTS.....	50
ARTICLE 15:	FIREARMS .....	54
ARTICLE 16:	BULLETIN BOARDS.....	55
ARTICLE 17:	TRAINING AND EDUCATION REIMBURSEMENT.....	56
ARTICLE 18:	PAST PRACTICE .....	58
ARTICLE 19:	SAVINGS CLAUSE .....	59
ARTICLE 20:	WORK STOPPAGES AND EMPLOYER PROTECTION.....	60
ARTICLE 21:	WAIVER CLAUSE.....	61
ARTICLE 22:	REDUCTION-IN-FORCE .....	62
ARTICLE 23:	EMPLOYEE BILL OF RIGHTS.....	64
ARTICLE 24:	DURATION .....	66
APPENDIX 1	FIREARMS RE-QUALIFICATION WITH FLOWCHART .....	67
APPENDIX 2	UNIFORMS	
ADDENDUM A	WAGE RATES	
ADDENDUM B	2019-2020 JLMIC BENEFITS AGREEMENT	
Attachment 1	TRANSFER REQUEST PROCEDURES	

**AGREEMENT  
BETWEEN  
KING COUNTY  
AND**

**KING COUNTY CORRECTIONS GUILD  
DEPARTMENT OF ADULT AND JUVENILE DETENTION**

**ARTICLE 1: POLICY AND PURPOSE**

**Section 1.1. Policy.** These articles constitute an Agreement, the terms of which have been agreed upon by the parties King County, hereinafter referred to as the County, and King County Corrections Guild, hereinafter referred to as the Guild.

**Section 1.2. Purpose.** The intent and purpose of this Agreement is to promote the continued improvement of the relationship between the County and its employees by providing a uniform basis for implementing the right of public employees to join organizations of their own choosing; to be represented by such organizations in matters concerning their employment relations with the County; and to set forth the wages, hours, and other working conditions of such employees in appropriate bargaining units, provided the County has authority to act on such matters, and further provided the matter has not been delegated to any civil service commission or personnel board similar in scope, structure, and authority as defined in RCW 41.56.

**Section 1.3. Nondiscrimination.** The County and the Guild agree that they will not illegally discriminate against any employee by reason of race, color, age, sex, marital status, sexual orientation, political ideology, creed, religion, ancestry, national origin, or the presence of any sensory, mental, or physical disability.

1 **ARTICLE 2: GUILD RECOGNITION AND MEMBERSHIP**

2           **Section 2.1. Exclusive Recognition.** The King County Council recognizes the Guild,  
3 Certification No. 12491-E-96-2087, as certified on September 10, 1996 by the Public Employment  
4 Relations Commission (PERC), as representing regular full-time Corrections Officers and  
5 Corrections Sergeants employed by the King County Department of Adult and Juvenile Detention  
6 (the Department). If the County decides to use part-time positions to perform work currently  
7 performed by Guild members, those part-time employees will be represented by the Guild. The  
8 County will bargain with the Guild concerning wages, hours and working conditions for such part-  
9 time employees.

10           **Section 2.2. Guild Membership.** All employees covered under the terms of this Agreement  
11 may voluntarily join the Guild as a member.

12           **Section 2.3. Dues Deduction.** Upon written receipt from the Guild Secretary of a voluntary  
13 authorization by an employee covered under Section 2.1 of this Article, the County shall have  
14 deducted from the pay of such employee, the amount of dues, charges, assessments, and/or fees as set  
15 by the Guild and shall transmit the same to the treasurer of the Guild. If the County receives such  
16 authorization directly from an employee, it shall forward such request to the Guild as soon as  
17 practicable. The County shall end payroll deduction for an employee after it receives confirmation  
18 from the Guild Secretary regarding the employee's revocation; the termination of such deduction  
19 shall take place no later than the second payroll after receipt of the confirmation.

20           The Guild will indemnify, defend, and hold the County harmless against any claims made and  
21 against any suit instituted against the County on account of any check-off of dues, charges,  
22 assessments, and/or fees for the Guild. The Guild agrees to refund to the County any amounts paid to  
23 it in error on account of the check-off provision upon presentation of proper evidence thereof.

24           **Section 2.4. New Hires.** In accordance with RCW 41.56.037, the Parties agree that the  
25 Guild will be provided sixty (60) minutes access to new hires at the Departmental new employee  
26 orientation.

1           **Section 2.5. New Hire/Separation Information.** The Department shall supply to the Guild  
2 the following information within fourteen (14) calendar days of a new employee’s date of hire or new  
3 Guild eligibility:

- 4           • First and last names
- 5           • U.S. mailing address
- 6           • Date of hire
- 7           • Rate of pay
- 8           • FTE status

9 On a monthly basis, the Department shall also provide notice to the Guild regarding employee  
10 separations which shall contain the name of the employee, date of separation, and the basis of the  
11 separation (retirement, resignation, termination, etc.).

12           **Section 2.6. Employment Lists.** The County will transmit to the Guild a current listing of  
13 all employees in the bargaining unit within thirty (30) calendar days of request for same but not to  
14 exceed twice per calendar year. Such list shall include the name of the employee, classification,  
15 division, work location, email address, phone number if the employee provides it, and salary.

16           **Section 2.7. Overtime Reports.** No more than monthly, the Guild may request a report that  
17 describes the utilization of overtime on a voluntary and mandatory basis, which the County will  
18 thereby provide. The parties agree that copying the Guild on the distribution of the overtime report  
19 required by the proviso from County Council satisfies this obligation.

1 **ARTICLE 3: MANAGEMENT RIGHTS**

2 It is recognized that the County retains the right to manage the affairs of the County and to  
3 direct the work force. Such functions of the County include, but are not limited to:

4 A. Determine the mission, budget, organization, number of employees, and internal  
5 security practices of the Department of Adult and Juvenile Detention;

6 B. Recruit, examine, evaluate, promote, train, transfer employees of its choosing, and  
7 determine the time and methods of such action;

8 C. Discipline, including but not limited to, suspending, demoting, or dismissing  
9 employees for just cause; provided that when a transfer is intended as a disciplinary sanction, it is  
10 subject to the Just Cause requirement;

11 D. Assign, direct and reduce the work force; develop and modify class specifications  
12 and assign positions to such classes; determine the method, materials, and tools to accomplish the  
13 work; designate duty stations and assign employees to those duty stations. Management will not  
14 replace or reclassify uniform positions with non-uniform positions for the duration of this Agreement;

15 E. Establish reasonable work rules; assign the hours of work and take whatever  
16 actions may be necessary to carry out the Department of Adult and Juvenile Detention’s mission in  
17 case of emergency.

18 F. Uniforms: the Department may change or modify its requirement with respect to  
19 the uniforms worn by its employees.

20 G. Video Cameras: to enhance the utility of video cameras, the Department may add  
21 a recording capability to video cameras in all facilities. Video recordings shall only be reviewed in  
22 connection with a specific concern or a specific incident. An employee who is the subject of an on-  
23 shift investigation or IIU investigation into alleged or suspected misconduct including, but not limited  
24 to, suspected failure to report a use of force and preliminary investigations being conducted into uses  
25 of force, where there is a suspected violation of policy or procedure shall be allowed upon request to  
26 privately view the video with a Guild representative prior to their interview concerning the alleged

1 misconduct. Review of video will generally not be allowed in advance of submitting routine reports.  
2 Normally routine reports are those reports submitted by the employee prior to going off duty on the  
3 shift during which the incident occurred or during the employee's next scheduled shift.

4 **H.** Unless specifically negotiated otherwise or contradicted in a specific provision of  
5 this Agreement, the 2005 King County Personnel Guidelines in effect on March 16, 2009, shall cover  
6 all employees and classifications in this bargaining unit except with respect to promotional  
7 procedures and with respect to the Guidelines deletion of the word "confidential" in section 13.5  
8 describing the Employee Assistance Program.

9  
10  
11  
12  
13  
14  
15  
16  
17  
18  
19  
20  
21  
22  
23  
24  
25  
26  
27  
28

1 **ARTICLE 4: GUILD REPRESENTATION**

2           **Section 4.1. Appointment to Guild Position.** An employee elected or appointed to a Guild  
3 office which requires a part or all of their time shall be given a leave of absence of up to one (1) year  
4 without pay, upon application. This applies to only one (1) employee at any given time.

5           **Section 4.2. Business Leave Bank.** The Guild will establish a business leave bank for Guild  
6 activity. The business leave bank hours shall be established through the deduction of vacation,  
7 compensatory or holiday hours only (excluding probationary employees). The default deduction  
8 shall be from the employee’s vacation bank unless another leave type is specified by the employee.

9 Employees must inform payroll within two (2) weeks of the notice from the Guild if they wish to  
10 have compensatory time or holiday leave used. Notification to the employees of this option shall be  
11 the responsibility of the Guild. Up to two (2) hours annually may be deducted from each employee’s  
12 leave account to fund the leave bank. An employee who received a no-pay based on Guild leave  
13 bank deductions will not be disciplined. The County agrees to administer the business leave bank  
14 account, provided the Guild has the sole discretion to determine who may use the business leave bank  
15 and under what circumstances. The release of employees for Guild business leave shall not be  
16 unreasonably withheld as long as the employee provides the County with a minimum of two (2) days  
17 of notice of intent to use Guild leave, except in emergencies at the request of the Guild President with  
18 one (1) day of notice. Members of the Guild Board, inclusive of shift representatives and executive  
19 officers, will not be required to work mandatory overtime if doing so would prevent them from  
20 attending a Board meeting scheduled pursuant to this section, unless a non-staffing related emergency  
21 is occurring. Based on the current reimbursement process, an employee may use their accrued  
22 vacation, compensatory, or holiday time off balances as Guild leave and then be reimbursed from the  
23 Guild leave bank. An employee on approved Guild business leave shall not be subject to discipline  
24 for going into a “no pay” status. Participating Guild members will not be required to use Guild leave  
25 to attend Labor/Management meetings.

26           **Section 4.3.** An employee selected by the Department of Adult and Juvenile Detention



1 (DAJD) for temporary assignment of up to two (2) years in a facility other than a DAJD facility  
2 (including, but not limited to the State Academy, State Criminal Justice Training Commission, or the  
3 National Institute of Corrections), shall continue to be covered by all applicable Articles of this  
4 agreement.

5 An employee accepting a job with an outside agency which requires the employee to sign a  
6 personal services contract, shall be covered by the Articles of the Agreement listed in the prior  
7 paragraph. The following restrictions shall be placed on assignments that involve personal services  
8 contracts with outside agencies.

9 1. The County shall only approve personal service contracts where the job was posted  
10 and all interested, eligible persons were allowed to apply.

11 2. To be eligible for such assignment, the employee must have been a Correction  
12 Officer for at least three (3) years.

13 3. An employee is only eligible for such assignment once every six (6) years;

14 4. An employee returning from such assignment must wait at least six (6) months  
15 from the time of their return to be eligible to be promoted to Sergeant.

16 Where allowable, for temporary assignments that do not involve a personal service contract,  
17 the County shall continue its practice of selecting employees to be assigned.

18 **Section 4.4. Guild Representatives.** The Department shall afford Guild representatives a  
19 reasonable amount of time while in on-duty status to consult with appropriate management officials  
20 and/or aggrieved employees, provided that the Guild representatives and/or aggrieved employees  
21 contact their immediate supervisors, indicate the general nature of the business to be conducted, and  
22 request necessary time without undue interference with assignment duties. Time spent on such  
23 activities shall be recorded by the Guild representatives on a time sheet provided by the supervisor.  
24 Guild representatives shall guard against use of excessive time in handling such responsibilities.

25 **Section 4.5. Guild Leave Time.** Guild representatives shall indicate their use of Guild leave  
26 time on absence request forms, utilizing appropriate codes, and indicating start and end times of

1 hours used.

2           **Section 4.6. Seniority.** Seniority is established as the employee’s date of hire for all Officers  
3 and the employee’s date of promotion for all Sergeants. For employees with the same date of hire the  
4 following criteria will be used to determine seniority:

- 5                   1<sup>st</sup> - Previous DAJD Service;
- 6                   2<sup>nd</sup> - Previous WSCJTC or DOC corrections officer academy graduation date;
- 7                   3<sup>rd</sup> - Previous other adult corrections experience;
- 8                   4<sup>th</sup> - Previous other law enforcement experience;
- 9                   5<sup>th</sup> - Previous King County employment;
- 10                  6<sup>th</sup> - Approved for hire date;
- 11                  7<sup>th</sup> - Application submittal date; and
- 12                  8<sup>th</sup> - Names randomly drawn by the Guild President during an open meeting.

13           Proof of eligibility for each criterion above will be the ultimate responsibility of the  
14 employee. For Sergeants with the same date of promotion, the employee with the earlier seniority  
15 date as an Officer will be placed ahead of the other(s).

16           Employees in a no-pay status for more than ninety (90) consecutive days will have their  
17 seniority date adjusted day for day starting on the ninety-first (91<sup>st</sup>) day. This will cause the employee  
18 to fall from an earlier seniority date to a later one. In this instance when an employee falls from an  
19 earlier seniority date to a later one resulting in a tie, the employee falling from above will be placed  
20 above others.

21           For employees who leave the bargaining unit for more than two (2) years their seniority date  
22 will be the date of their return to the bargaining unit. For employees who leave the bargaining unit  
23 for two (2) years or less the number of days out of the bargaining unit will be deducted. This will  
24 cause the employee to fall from an earlier seniority date to a later one. In this instance when an  
25 employee falls from an earlier seniority date to a later one resulting in a tie, the employee falling from  
26 above will be placed below others.

1 Sergeants who are involuntarily demoted or who bump into an officer position through the  
2 Reduction-in-Force process shall combine both Officer and Sergeant seniority (original date of hire  
3 subject to above adjustments). Sergeants who elect to take a demotion retain only their seniority as  
4 an Officer (original date of hire subject to above adjustments and adjusted for time as Sergeant).  
5 Sergeants who are recalled through the Reduction-in-Force process shall have their seniority include  
6 any previous time spent as Sergeant.

7 These criteria will not be used to undo any seniority issues that were decided by criteria that  
8 were appropriately applied in the past. These criteria do not apply to other dates such as an  
9 employee's adjusted service date.

10  
11  
12  
13  
14  
15  
16  
17  
18  
19  
20  
21  
22  
23  
24  
25  
26  
27  
28

1 **ARTICLE 5: HOLIDAYS**

2 **Section 5.1. Observed Holidays.** The Parties shall continue to observe the following paid  
3 holidays:

4	5	New Year's Day	(January 1)
6	6	Martin Luther King Jr. Day	(third Monday of January)
7	7	President's Day	(third Monday of February)
8	8	Memorial Day	(last Monday of May)
9	9	Independence Day	(July 4)
10	10	Labor Day	(first Monday of September)
11	11	Veteran's Day	(November 11 or day of observance as outlined below)
12	12	Thanksgiving Day	(fourth Thursday of November)
13	13	Day after Thanksgiving Day	The Friday following Thanksgiving Day
14	14	Christmas Day	(December 25)

15  
16 If November 11 falls on a Saturday, Veteran's Day shall be observed on the preceding Friday.  
17 If November 11 falls on a Sunday, Veteran's Day shall be observed on the following Monday.

18 **Section 5.2. Holiday Observance.** All employees shall take holidays on the day of  
19 observance unless their work schedule requires otherwise, in which event they shall either be paid for  
20 the holiday or, if mutually agreed to by the employee and management, may be scheduled the same  
21 as a vacation day. If the holiday falls on an employee's furlough day and the employee does not  
22 work that day, the employee shall accrue 8.17 hours of holiday leave.

23 **Section 5.3. Existing Holiday Banks.** A maximum of 49.02 hours may be carried over from  
24 one calendar year to the next in an employee's holiday leave bank. For employees who are required  
25 to have 49.02 hours or less in their bank at the beginning of a calendar year any hours in excess of  
26 49.02 at the end of that calendar year shall be paid in cash. For employees who are grandfathered and

1 allowed to have more than 49.02 hours in their bank at the beginning of a calendar year, those hours  
2 above the maximum (49.02) must be reduced by 10% during that calendar year or the remainder of  
3 that 10% shall be paid in cash at the end of that calendar year. For the purposes of this section, “the  
4 end of the calendar year” shall indicate the end of the pay period that contains December 31, and “the  
5 beginning of the calendar year” shall indicate the start of the first full pay period of the new year.

6 **Section 5.4. Floating Holidays.** Each employee shall receive two (2) additional personal  
7 holidays to be administered through the vacation plan. One personal holiday shall be added to the  
8 vacation leave bank in the pay-period that includes the first day of October and one personal holiday  
9 will be added in the pay-period that includes the first day of November of each year. These days can  
10 be used in the same manner as any vacation day earned.

11 **Section 5.5. Holiday Time Accrual.** An employee’s paycheck will reflect the accrual of  
12 holiday time.

13 **Section 5.6. Holiday Premium Pay.** Employees whose work shift begins on the observed  
14 holidays set forth in Section 5.1 above, shall receive time-and-one-half (1.5) their Base Rate of pay  
15 for all hours worked as a holiday premium in addition to the holiday compensation described in  
16 Section 5.2.

17 **Section 5.7. Eligibility.** In order to be eligible for holiday pay or accrual, the employee must  
18 be in a paid status on the last regularly scheduled shift prior to and the first regularly scheduled shift  
19 after the holiday.

1 **ARTICLE 6: VACATION**

2 **Section 6.1. Accrual Rates.**

3 A. Benefit eligible full-time employees working forty (40) hours per week, shall  
 4 accrue vacation leave benefits as described in and further qualified by this section. Employees shall  
 5 receive vacation leave benefits based on an hourly accrual rate for each hour in pay status exclusive  
 6 of overtime up to the maximums indicated in the table below.

<b>Full Years of Service</b>	<b>Maximum Annual Leave in Days</b>
Upon hire through end of Year 5	12
Upon beginning of Year 6	15
Upon beginning of Year 9	16
Upon beginning of Year 11	20
Upon beginning of Year 17	21
Upon beginning of Year 18	22
Upon beginning of Year 19	23
Upon beginning of Year 20	24
Upon beginning of Year 21	25
Upon beginning of Year 22	26
Upon beginning of Year 23	27
Upon beginning of Year 24	28
Upon beginning of Year 25	29
Upon beginning of Year 26 and beyond	30

26 B. Part-time benefit eligible employees shall accrue vacation leave in accordance with

1 the vacation leave schedule set forth in paragraph A of this section, provided, however, such accrual  
2 rates shall be prorated (less overtime) to reflect their normally scheduled workweek.

3           **C.** Employees eligible for vacation leave shall accrue vacation leave from their date  
4 of hire. Employees shall not use or be paid for vacation leave until it has accrued, and is reflected on  
5 the employee’s pay stub, and such use or payment is consistent with the provisions of this section.

6           **D.** Full-time benefit eligible employees may accrue up to sixty (60) (490.2 hours for  
7 employees working 8.17 hours per shift) days of vacation leave per year. Part-time benefit eligible  
8 employees may accrue vacation leave up to sixty (60) (490.2 hours for employees working 8.17 hours  
9 per shift) days per year prorated to reflect their normally scheduled workweek. Such employees shall  
10 use vacation leave beyond the maximum accrual amount prior to the end of the pay period that  
11 includes December 31 of each year. Failure to use vacation leave beyond the maximum accrual  
12 amount will result in forfeiture of the vacation leave beyond the maximum amount unless the  
13 Director or designee has approved a carryover of such vacation leave because of cyclical workloads,  
14 work assignments or other reasons as may be in the best interest of the County. The maximum  
15 vacation accrual amount established in this paragraph shall apply to vacation accruals as of the  
16 effective date of this new benefit, as described in Section 6.1(A) above.

17           **E.** Employees who leave County employment prior to successfully completing their  
18 first year of County service shall forfeit and not be paid for accrued vacation leave. Full-time benefit  
19 eligible employees and part-time benefit eligible employees shall be paid for accrued vacation leave  
20 to their date of separation up to the maximum accrual amount if they have successfully completed  
21 their first year of County service. Payment shall be the accrued vacation leave multiplied by the  
22 employee’s Base Rate of pay in effect upon the date of leaving County employment less mandatory  
23 withholdings.

24           **F.** No employee shall work for compensation for the County in any capacity during  
25 the time that the employee is on vacation leave.

26           **G.** Vacation leave may be used in fifteen (15) minute increments (unless leave usage

is for a full day or will exhaust an employee’s leave balance), at the discretion of the Director/designee.

**H.** In cases of separation from County employment by death of an employee with accrued vacation leave and who has successfully completed their first year of County service, payment of unused vacation leave up to the maximum accrual amount shall be made to the employee’s estate, or, in applicable cases, as provided for by state law, RCW Title 11.

**I.** If an employee resigns from County employment in good standing or is laid off and subsequently returns to County employment within two (2) years from such resignation or layoff, as applicable, the employee’s prior County service shall be counted in determining the vacation leave accrual rate under paragraph A of this section.

**Section 6.2. Vacation Scheduling.**

**A.** Vacation preference requests for a period beginning April 1st and ending the following March 31st, will be processed after annual rotation with a goal of being completed by the end of February preceding the twelve (12) month period during which the vacation is being requested in order to receive scheduling preference. Vacation preference requests shall be granted based upon seniority within each shift, provided that essential facility operations are properly staffed at all times. Employees shall be advised by April 1st regarding approval or disapproval of their requests.

The number of vacation slots available for each shift shall be as follows:

	<u>KCCF</u>		<u>N.M. RJC</u>	
	First Shift	10	First Shift	7
	Second Shift	10	Second Shift	5
	Third Shift	8	Third Shift	4
	Fourth Shift	5	Fourth Shift	3
	<i>(Court Detail)</i>			



1           Additionally, a total leave vacation slot ratio of 1 slot per 10 FTE's will be maintained each  
2 year based on the number of FTE's provided in the annual budget. For example:

3           490 FTE's = 49 total vacation slots

4           490.1 FTE's = 50 total vacation slots

5           500 FTE's = 50 total vacation slots

6           500.1 FTE's = 51 total vacation slots

7 Changes in the number of vacation slots will be made in the month of the effective change in staffing  
8 (usually January) of each year. The specific shifts/locations for the additional slots shall be  
9 determined by management after discussing with the Guild in Labor/Management.

10           **B.** All vacation requests after annual bidding is completed shall be requested for  
11 approval from the Department at least seventy-two (72) hours prior to the time being requested in  
12 order to have consideration based upon available leave slots. Any requests within seventy-two (72)  
13 hours of the start of the shift or during the shift shall be reviewed for approval on a case-by-case basis  
14 based on available leave slots per current practice and shall be approved unless the approval would  
15 result in mandatory overtime. All requests for vacation leave must be approved by a Supervisor  
16 authorized to approve leave requests.

17           **C.** Positions that are not backfilled for shall not count against the vacation leave slots  
18 (for example: Policy and Procedures). Employees on approved Guild Leave shall not count against  
19 the vacation leave slots.

20           **D.** Employees who are transferred involuntarily, and who have already had their  
21 vacation requests approved, will be allowed to retain that vacation period regardless of their seniority  
22 within the shift to which they are transferred.

23           **E.** Employees who are determined to have inadequate leave hours available to use for  
24 annual vacation bids will be notified of their deficiency and the Department will cancel their annually  
25 bid vacation period. The vacant leave slots created due to this cancellation will be offered to the next  
26 employee on the wait list, or posted up for all eligible employees to request.

1           **F.** Employees wishing to cancel vacation days that were obtained as a result of annual  
2 vacation bidding must notify the Department of cancellation at least seventy-two (72) hours prior.  
3 This requirement does not negate an employee’s ability to cancel particular days only of annually bid  
4 vacation periods; but will support the Department’s efforts to re-distribute available leave slots to  
5 employees on the stand-by list, or to post up for all eligible employees to request.

6 Exceptions to the seventy-two (72) hour rule will be granted if:

- 7           1. Cancelling scheduled vacation would reduce/eliminate overtime for the shift.
- 8           2. Cancelling scheduled vacation would allow another employee on the wait list (in order) to  
9           take leave, or another employee to take leave when no one is on the wait list, or
- 10          3. Cancelling scheduled vacation would prevent the employee from going into a no-pay  
11          status.

12           **Section 6.3. Vacation Leave Donations.** Employees in the bargaining unit shall be allowed  
13 to donate vacation leave in accordance with the provisions set forth in King County Code 3.12.223,  
14 as amended.

15           **Section 6.4. Transfers.** If an employee with approved vacation voluntarily transfers to  
16 another assignment at a time other than annual rotation, their vacation request shall be cancelled.  
17 Employees will be notified of this policy prior to approval of the transfer request. The employee  
18 must submit a new vacation request upon transfer. Such request will be evaluated based on vacation  
19 availability at the new assignment.

20           **Section 6.5. Vacation Cancellation.** If the Department cancels an employee’s vacation once  
21 it has been approved and affected employee has incurred non-refundable expenses in planning for  
22 said vacation, the employee shall be reimbursed for any non-refunded expenses incurred by the  
23 employee. This shall include any additional costs incurred by the employee in returning home early  
24 to report to work. This reimbursement shall be conditioned on the employee informing the  
25 Department at the time of cancellation notification of the potential non-refundable expenses.

1 **ARTICLE 7: SICK LEAVE**

2 **Section 7.1. Accrual Rates.** Full-time regular, part-time regular, provisional, probationary  
3 and term limited employees (“employees eligible for comprehensive benefits”) shall accrue sick  
4 leave benefits at the rate of 0.04616 hours for each hour in pay status exclusive of overtime, except  
5 that if an hourly employee works in excess of 74 hours in one week, the employee will accrue sick  
6 leave at the rate of .025 for each hour worked in excess of 74 hours. An employee is not entitled to  
7 sick leave if not previously earned.

8 **Section 7.2. Vacation as Extension of Sick Leave.** During the first year of service,  
9 employees eligible to accrue vacation leave may, at the Director’s/designee’s discretion, use any  
10 accrued days of vacation leave as an extension of sick leave. If an employee does not work a full  
11 year, any vacation leave used for sick leave must be reimbursed to the County upon termination. The  
12 terms of this provision do not apply to employees using accrued vacation leave for a qualifying event  
13 under the Washington Family Care Act.

14 **Section 7.3. Increments of Use.** Sick leave may be used in fifteen (15) minute increments.

15 **Section 7.4. Notice.** Sick calls for all foreseeable absences must be made prior to the shift  
16 start time, in accordance with current practice, to facilitate adequate time to seek volunteers to cover  
17 posts that must be backfilled. For non-foreseeable absences, sick call must be made as soon as  
18 possible before the start of the shift, unless it is not practicable for the employee to do so.

19 **Section 7.5. Limit.** There is no limit to the hours of sick leave accrued by an employee  
20 eligible for comprehensive leave benefits.

21 **Section 7.6. Administration of Benefit.** Management is responsible for the proper  
22 administration of this benefit, in compliance with King County Ordinances, Washington Law, and  
23 Federal law.

24 **A.** Employees shall complete an absence request form on the first day back to work  
25 after an illness. Employees may be required to provide a physician’s verification (using currently  
26 approved forms) for any absence of more than three (3) consecutive work days if there is a specific

1 concern regarding the validity of an employee’s absence or ability to safely return to work.

2           **B.** It shall be the employees’ responsibility to notify the Department when submitting  
3 their required leave request forms if the leave is for a Family Medical Leave (FML) qualifying event.  
4 If sick leave is used, a statement explaining the requirement for said leave shall be included with the  
5 absence request form.

6           **C.** If verification of illness is required for an employee’s absence exceeding three (3)  
7 consecutive work days, the Department will make a reasonable effort to inform the employee of the  
8 need for such verification prior to their return to work. The employee shall be given not less than ten  
9 (10) calendar days following the first day upon which the employee used paid sick leave to provide  
10 the verification. If the County requires verification and the employee anticipates that the requirement  
11 will result in an unreasonable burden or expense, the employee may provide an oral or written  
12 explanation asserting that the employee’s use of paid sick leave was for an authorized purpose and  
13 describing how the County’s verification requirement creates an unreasonable burden or expense on  
14 the employee. The County shall consider the employee’s explanation as required by Washington law.  
15 The County shall not require that the verification provided by the employee explain the nature of the  
16 employee’s condition. The County shall treat any health information about an employee or an  
17 employee’s family member in a confidential manner.

18           **D.** Except in extraordinary circumstances, failure to notify an employee prior to their  
19 return to work relieves the employee of the responsibility to provide medical verification of illness, if  
20 so requested. “Extraordinary circumstances” for the purpose of this Article includes weekends or  
21 holidays where administrative staff is not on duty to evaluate sick leave use.

22           **E.** In addition, after an absence of more than three (3) consecutive work days, the  
23 County may require the employee to submit a FMLA/KCFML certification for leaves that may  
24 qualify as family medical leave pursuant to this Article. The limitations stated above regarding  
25 verification of illness apply to the County’s request for an FMLA/KCFML certification.

26           **Section 7.7. Separation from County Employment.**

1           A. Separation from or termination of County employment except by reason of  
2 retirement or layoff due to lack of work, funds or efficiency reasons, shall cancel all sick leave  
3 accrued to the employee as of the date of separation or termination. Should an employee return to  
4 County employment within two (2) years of separation or termination, accrued sick leave shall be  
5 restored.

6           B. Employees eligible for comprehensive leave benefits and who have successfully  
7 completed at least five (5) years of County service and who retire as a result of length of service or  
8 who terminate by reason of death shall be paid, or their estates paid or as provided for by RCW Title  
9 11, as applicable, an amount equal to thirty-five percent (35%) of their unused, accumulated sick  
10 leave multiplied by the employee's Base Rate in effect upon the date of leaving County employment,  
11 less mandatory withholdings. This pay out shall be in accordance with the Voluntary Employee  
12 Beneficiary Association (VEBA) as long as such remains accepted by the members of this bargaining  
13 unit.

14           **Section 7.8. Reasons for Use.** Accrued sick leave may be used for the following reasons:

15           A. An absence resulting from an employee's mental or physical illness, injury, or  
16 health condition: to accommodate the employee's need for medical diagnosis, care, or treatment of a  
17 mental or physical illness, injury, or health condition; or for an employee's need for preventive  
18 medical care;

19           B. To allow the employee to provide care for a family member with a mental or  
20 physical illness, injury, or health condition; a family member who needs medical diagnosis, care, or  
21 treatment of a mental or physical illness, injury, or health condition; or a family member who needs  
22 preventive medical care;

23           C. When the employee's workplace has been closed by order of a public official for  
24 any health related reason, or when the employee's child's school or place of care has been closed by  
25 order of a public official for any health-related reason.

26           D. For absences that qualify for leave under the domestic violence leave act, RCW

1 49.76.

2 **Section 7.9. Definition of Family Member.** For purposes of sick leave, “family member”  
3 includes the following:

4 **A.** a child, including a biological, adopted or foster child, stepchild, or a child to  
5 whom the employee stands in loco parentis, is legal guardian, or is a de facto parent, regardless of age  
6 or dependency status;

7 **B.** a biological, adoptive, de facto, or foster parent, stepparent, or legal guardian of an  
8 employee or the employee’s spouse or registered domestic partner, or a person who stood in loco  
9 parentis when the employee was a minor child;

10 **C.** a spouse; registered domestic partner; a grandparent; a grandchild; or sibling.

11 **Section 7.10. Sick Leave and Worker’s Compensation Payments.** An employee who  
12 suffers an occupational illness or who is injured on the job may not simultaneously collect sick leave  
13 and worker’s compensation payments in a total amount greater than the regular pay of the employee.

14 **Section 7.11.** Employees may use sick leave to care for family members if the employee has  
15 been employed by the County for more than eighty-nine (89) days and the use of sick leave is in  
16 accordance with local, state and federal law, including the Washington Family Care Act.

17 **Section 7.12.** Use of paid sick leave as provided in this Agreement shall not lead to or result  
18 in discipline of any employee. The County shall not discriminate or retaliate against any employee  
19 for the employee’s use of paid sick leave as provided in this Agreement, Washington law, or Federal  
20 law.

21 **Section 7.13. Bereavement Leave.**

22 **A.** Regular, full-time employees shall be entitled to up to three (3) days of  
23 bereavement leave per occurrence due to death of a member of the employee’s immediate family.

24 **B.** Regular full-time employees who have exhausted their bereavement leave, shall be  
25 entitled to use leave in the amount of three (3) days for each instance when death occurs to a member  
26 of the employee’s immediate family.

1                   **C. Immediate Family for Purposes of Bereavement Leave.** Immediate family is  
2 construed to mean spouse, child, parent, son-in-law, daughter-in-law, grandparent, grandchild,  
3 sibling, domestic partner and the child, parent, sibling, grandparent or grandchild of the spouse or  
4 domestic partner.

5                   **Section 7.14.** Written verification for family care may be required by management, as  
6 provided in Section 7.6 above.

7                   **Section 7.15. Federal Family and Medical Leave Act (FMLA) Entitlement.** As provided  
8 for in the FMLA, an eligible employee may take up to a combined total of twelve (12) weeks of leave  
9 for their own serious health condition (as defined by the FMLA) and for the birth or placement by  
10 adoption or foster care of a child, or for the serious health condition of an immediate family member  
11 (an employee’s child, spouse or parent), within a twelve (12) month period. To be eligible for FMLA  
12 leave, an employee must have been employed by the County for twelve (12) months or more and  
13 have worked a minimum of one thousand, forty (1040) hours in the preceding twelve (12) months.  
14 The leave may be continuous or intermittent. The leave shall run concurrently with King County  
15 Family Medical Leave benefit below.

16                   **Section 7.16. King County Family and Medical Leave (KCFML) Entitlement.** An  
17 employee may take up to a total of eighteen (18) weeks of unpaid leave for their own serious health  
18 condition (as defined by the King County Personnel Guidelines), and for family reasons (as defined  
19 in the King County Personnel Guidelines) as provided for in Sections 7.7 and 7.10 above, within a  
20 twelve (12) month period. To be eligible for KCFML leave, an employee must have been employed  
21 by the County for twelve (12) months or more and have worked a minimum of one thousand, forty  
22 (1040) hours in the preceding twelve (12) months (for a forty-hour employee).

23                   **Section 7.17.** FML leave may be continuous (which is consecutive days or weeks), or  
24 intermittent (which is taken in whole or partial days as needed). Intermittent leave is subject to the  
25 following conditions:

26                   **A.** When leave is taken after the birth or placement of a child by adoption or foster

1 care, an employee may take leave intermittently or on a reduced leave schedule only if authorized by  
2 the Department Director or designee;

3 **B.** An employee may take leave intermittently or on a reduced schedule when  
4 medically necessary due to a serious health condition of the employee or family member of the  
5 employee. If this leave is foreseeable based on planned medical treatment, the Department Director  
6 or their designee may require the employee to transfer temporarily to an available alternative position  
7 for which the employee is qualified and that has equivalent pay and benefits and that accommodates  
8 recurring period of leave.

9 **Section 7.18. Washington Family Care Act.** An employee may use accrued vacation or  
10 sick leave for a qualifying event under the Washington Family Care Act. For leave that does not  
11 qualify under the Washington Family Care Act or the Family Medical Leave Act, the following  
12 applies: An employee who has exhausted all of their sick leave may use accrued vacation leave as  
13 sick leave before going on leave of absence without pay provided after four (4) days of vacation leave  
14 have been used as an extension of sick leave during each six (6) month period of the calendar year  
15 (January through June, July through December), use of additional vacation leave for this purpose is  
16 subject to the Employer's prior approval.

17 **Section 7.19. Accrued Leave Usage.** An employee shall not be required to use all of their  
18 accrued sick leave, and any donated sick leave before taking unpaid leave for their own health  
19 reasons, at such time the employee begins utilizing short-term disability benefits. For a leave for  
20 family reasons, the employee shall choose at the start of the leave whether the particular leave would  
21 be paid or unpaid; but when an employee chooses to take paid leave for family reasons they may set  
22 aside a reserve of up to eighty (80) hours of accrued sick leave. An employee who has exhausted all  
23 of their sick leave may use accrued vacation leave before going on leave of absence without pay, if  
24 approved by the Director or designee, or as provided by Federal law. Use of donated leave shall be  
25 counted against the employee's leave entitlement under King County Family and Medical Leave.

26 **Section 7.20.** In the application of any of the foregoing provisions, when a qualifying, paid



1 holiday or furlough day falls within the prescribed period of absence, it shall not be charged against  
2 sick leave accrual.

3 **Section 7.21. Concurrent Running of Leave.** To the extent permitted by law, the leaves  
4 outlined in this Agreement (including leave for industrial injury) shall run concurrently.

5 **Section 7.22. Special Sick Leave.** All newly hired Corrections Officers shall be provided  
6 with thirty (30) days (245.1 hours for employees working 8.17 hour work shifts) special sick leave,  
7 which shall be used only to supplement the employee’s industrial insurance benefit should the  
8 employee be injured on the job during their first calendar year on the job. The special sick leave shall  
9 not be used until three (3) days (24.51 hours for employees working 8.17 hour work shifts) of regular  
10 sick leave have been used for each instance of on the job injury. After the first three (3) days (24.51  
11 hours for employees working 8.17 hour work shifts) of leave, the employee must use special sick  
12 leave prior to using regular sick leave when on an FMLA qualified industrial injury leave. During  
13 the second year of employment, and for all succeeding years, all Corrections Officers shall be  
14 provided with twenty (20) days (163.4 hours for employees working 8.17 hour work shifts) special  
15 sick leave which shall only be utilized in the circumstances as herein described. Special sick leave is  
16 non-cumulative, but is renewable annually.

17 **Section 7.23. Organ Donor Leave.** Employees shall be eligible for organ donor leave  
18 consistent with King County Code 3.12.215.

19 **Section 7.24. Sick Leave Donations.** Employees in the bargaining unit shall be allowed to  
20 donate sick leave in accordance with the provisions set forth in King County Code 3.12.223, as  
21 amended.

22 **Section 7.25. Paid Parental Leave.** Paid Parental Leave shall be granted to Employees  
23 pursuant to King County Code Section 3.12.219 and 3.12.221, for the birth of an Employee’s child,  
24 the Employee’s adoption of a child, or the foster-to-adopt placement of a child with the Employee.

25 **Section 7.26.** Pre-scheduled use of sick leave for medical appointments shall not count  
26 against leave slots.

1           **Section 7.27.** Employees needing to attend medical appointments, but who have exhausted  
2 their sick leave due to an on-the-job-injury (OJI) or FMLA/KCFML certified reasons may use any  
3 available leave banks, or leave without pay if they have no leave balances, to attend these  
4 appointments. Medical documentation may be required to be submitted to DAJD HR upon return to  
5 work after these appointments. Such employees may use vacation leave, holiday leave, or  
6 compensatory time off (CTO) for all follow-up appointments related to the OJI or FMLA/KCFML.

7  
8  
9  
10  
11  
12  
13  
14  
15  
16  
17  
18  
19  
20  
21  
22  
23  
24  
25  
26  
27  
28

1 **ARTICLE 8: WAGE RATES**

2 **Section 8.1. 2020-2021 Wage Rates.** Effective January 1, 2020, the base wage rates of  
3 bargaining unit members in effect December 31, 2019, shall be increased by 2.25%. This general  
4 wage increase is reflected in the wage rates listed in Addendum A. There shall be no general wage  
5 increase in 2021.

6 **Section 8.2. Work in Higher Classification.** Whenever an employee is assigned, in writing,  
7 by the Department Director or designee, to perform the duties of a higher classification, that  
8 employee shall be paid five percent (5%) over their Base Rate received prior to the assignment, for  
9 all time spent while so assigned. Sergeants working in the capacity of Acting Shift Commander shall  
10 be compensated at the rate of Step 5, of the Captain’s pay range. In circumstances where the  
11 Captain’s pay range is adjusted and there is a retroactive application of that adjustment, that same  
12 application shall be provided to Acting Shift Commanders for the same period of time.

13 **Section 8.3. Field Training Officer (FTO) Pay.** Employees assigned, in writing, by the  
14 Department Director or designee to perform FTO duties, shall be compensated at a rate which is five  
15 (5) percent greater than their regular rate for all time so assigned.

16 **Section 8.4. Firearms Qualified Premium.**

17 **A.** All bargaining unit employees that are gun qualified shall receive a premium of  
18 three point thirty-three percent (3.33%) of their Base Rate.

19 **B.** The Department shall determine the number of employees that may be gun  
20 qualified. Provided, however, that the Department will not limit the number of Sergeants that may  
21 attempt to become qualified for the firearms premium. Further agreement on the subject of Firearms  
22 Re-Qualification is attached hereto as Appendix 1.

23 **Section 8.5. Free Parking.** The County shall provide free parking in a King County garage  
24 for all employees regardless of their work location. Free parking is provided only to employees who  
25 are parking in connection with their work.

26 **Section 8.6. No Pay Periods and Incentive Pays.** For pay periods where employees

1 experience leave without pay, no incentives shall apply to actual hours spent in no pay status.

- 2
- 3
- 4
- 5
- 6
- 7
- 8
- 9
- 10
- 11
- 12
- 13
- 14
- 15
- 16
- 17
- 18
- 19
- 20
- 21
- 22
- 23
- 24
- 25
- 26
- 27
- 28

1 **ARTICLE 9: OVERTIME AND DEFINITIONS**

2 Overtime is that work which is directed by management. The parties acknowledge that it is the  
3 Department's policy to minimize the use of overtime and, further, that nothing in this Agreement  
4 shall be construed as a guarantee of overtime. Eligibility to work overtime shall be determined by the  
5 Department.

6 **Section 9.1. Definitions.**

7 **A. Base Rate:** An employee's hourly wage as listed under Addendum A and based on  
8 current step, excluding any and all premium pays or other wage modifiers. Wherever this Agreement  
9 calls for any multiplier of pay it shall be paid using the employee's Base Rate, unless the Article  
10 specifically states otherwise, or the Fair Labor Standards Act (FLSA) requires a higher method of  
11 compensation.

12 **B. Regular Rate:** That rate required under the FLSA when computing FLSA-  
13 qualified overtime.

14 **C. Contract Overtime:** Overtime required under the terms of the collective bargaining  
15 agreement but not required under the FLSA.

16 **D. FLSA Overtime:** Overtime required under the FLSA whether or not required  
17 under the collective bargaining agreement.

18 **Section 9.2. Payment Rate.**

19 **A. Contract Overtime.** For Contract Overtime, Corrections Officers and Sergeants  
20 shall be paid at the rate of time-and-one-half (1.5) their Base Rate for all hours paid in excess of their  
21 regularly scheduled shift, inclusive of a one-half (1/2) hour meal period, or when working on a  
22 furlough day, consistent with the other provisions of this Article.

23 **B. FLSA Overtime.** For FLSA Overtime, Officers and Sergeants shall be paid their  
24 hours worked, plus one-half (0.5) the FLSA rate (also known as the regular rate). FLSA Overtime  
25 compensation shall include all remuneration required under the FLSA which includes, but is not  
26 limited to, the Base Rate, firearms qualification, educational incentive, language translation, FTO,

1 work in higher classifications, and longevity compensation provided for under this Agreement.

2       **Section 9.3.** Employees will be paid overtime for actual hours worked in excess of their  
3 regularly scheduled shift as long as the extra hours are performed consecutively (immediately before  
4 or after, with no break in time) to the work shift. Otherwise, the regularly scheduled weekly  
5 threshold will be used.

6       **Section 9.4.** Overtime shall not be submitted or paid for work of less than five minutes  
7 beyond a full shift. The County and the Guild agree that such time is *de minimis* and, therefore is not  
8 compensable under either the FLSA or the Minimum Wage Act. For overtime worked of five (5)  
9 minutes or more, the following rules shall apply:

10           **A.** Five (5) minutes or more, up to fifteen (15) minutes, will be compensated as  
11 fifteen (15) minutes of overtime.

12           **B.** Sixteen (16) minutes or more shall be compensated minute-for-minute.

13       **Section 9.5.** The Court Detail and Special Assignments whose hours are generally Monday-  
14 Friday, 0830 - 1630, shall be allowed to attend to doctors/medical appointments in increments of less  
15 than 8 hours and have said hours treated as “hours worked” for purpose of determining overtime  
16 eligibility.

17       **Section 9.6. Callout.** A minimum of four (4) hours at the overtime rate shall be allowed for  
18 each callout. Callouts are mandatory, unscheduled/unexpected orders to return to work. Where such  
19 overtime worked exceeds four (4) hours, the actual hours worked shall be paid at the overtime rate.  
20 The provisions of this section apply only when an employee, without prior notice, is required to  
21 return to work during a time they are not scheduled to work. This does not include scheduled  
22 overtime, meetings, and training sessions requiring a return to work, provided that employees who  
23 are assigned to a shift in which the majority (i.e., five (5) hours) of working hours falls between 11:00  
24 p.m. and 7:00 a.m. shall receive a minimum of two (2) hours at time-and-one-half (1-1/2 X) their  
25 Base Rate for meetings and/or training sessions. If the callout is worked immediately prior to or  
26 immediately after the normal scheduled shift, such callout is considered a shift extension/or

1 “consecutive hours” worked, not a callout.

2           **Section 9.7. Overtime Authorization.** All overtime shall be authorized by the Department  
3 Director or designee in writing. Saturday and Sunday work is not overtime when it is a regularly  
4 scheduled workday. If an employee works overtime, the employee must submit a completed  
5 overtime sheet to their supervisor by the end of the employee’s overtime shift. If the employee’s  
6 overtime shift is worked at a location other than the King County Correctional Facility (KCCF) or  
7 Maleng Regional Justice Center (MRJC), the employee must submit a completed time sheet to their  
8 supervisor within seventy-two (72) hours after the close of shift on which the overtime was worked.  
9 Employees who choose compensatory time for overtime in an Acting Assignment shall receive time-  
10 and-a-half at their usual (not Acting) rate.

11           **Section 9.8. Voluntary Overtime Distribution.** Overtime shall be distributed to employees  
12 who have signed up to work overtime as follows:

13                   A. The County will make a reasonable effort to offer overtime to the qualified  
14 employee with the fewest number of overtime hours worked in the calendar year.

15                   B. The Department may schedule overtime assignments for shift vacancies three (3)  
16 days in advance, drawing from the overtime sign up lists and using the lowest year to date overtime  
17 hours three (3) days prior to the vacant shift. Vacant shifts in excess of employees signed up on the  
18 list, or within three (3) days of the vacancy may be filled by available volunteers. If more than one  
19 employee volunteers for the same shift vacancy during this period, lowest year to date overtime hours  
20 will be used to determine assignment.

21           **Section 9.9. Court Detail Overtime.** Any court detail assignment that will extend past the  
22 normal 17:00 end of shift work will be assigned to second shift and that shift will be responsible for  
23 filling the assignment with current staff or overtime consistent with this agreement. Any hospital or  
24 clinic assignments scheduled to extend beyond 14:20 will be filled by second shift. Court detail  
25 officers will generally not be subject to mandatory overtime past 17:00 hours, when first or second  
26 shift employees are available, and more junior.

1           **Section 9.10. Shift 4 Overtime.** Prior to posting the shift roster, when a Shift 4 Officer has  
2 signed up for overtime and is eligible based upon year to date overtime hours, the Captain or Acting  
3 captain will verify that the Shift 4 Officer is willing to work. If confirmed, a radio call will be made  
4 in an attempt to fill the front part of the shift. If there is a volunteer to cover the front part of the  
5 shift, the Shift 4 Officer will be assigned. If no volunteers respond, the Captain will continue on the  
6 Voluntary Overtime List. The Captain will notify the Shift 4 Officer whether or not they were  
7 assigned.

8           **Section 9.11. Same Day Overtime and Leave Use.** It is agreed that regular and reliable  
9 attendance is a requirement of employment. As such, employees shall be prohibited from working  
10 overtime and taking leave for their normally scheduled shift of the same day, unless making an  
11 exception to this rule would benefit the County and employees by preventing an employee from  
12 being mandatoried on overtime.

13           **Section 9.12. Mandatory Overtime.** Mandatory overtime shall be defined as anytime an  
14 employee is directed by their supervisor not to leave work at the end of their shift or if the employee  
15 is required to stay five (5) minutes or longer after their shift (resulting in overtime) as a result of late  
16 relief.

17           **A. Ten (10) Day “Wheel”.** Mandatory overtime shall be assigned in reverse  
18 seniority order; however, a less senior employee shall not be required to work mandatory overtime  
19 within ten (10) days of previously working mandatory overtime as long as there are employees  
20 eligible for mandatory overtime on that shift who have not been subject to mandatory overtime within  
21 the last ten (10) days (e.g., an employee mandated on April 10 is not eligible for mandatory overtime  
22 until April 21 unless no one else is eligible).

23           In cases where all eligible officers have worked mandatory overtime during the ten (10) day  
24 period, mandatory overtime assignment shall be based first on number of times hit for mandatory  
25 overtime (Example, all eligible shall be hit once before any are hit twice), with reverse seniority as  
26 the tiebreaker. Sergeants will not be required to work mandatory overtime more than once in a ten



1 (10) day period. Sergeants may be mandatoried to fill an Acting Shift Commander vacancy once in  
2 the same ten (10) day period as above, where no Captain can be utilized. A Sergeant who is  
3 mandatoried a maximum of twice with the above combination of Sergeant and Acting Shift  
4 Commander shall be paid double time for the second mandatory assignment.

5 **B. Mandatory Overtime before Furlough and Leave Days.** No employee shall be  
6 considered for mandatory overtime as an extension of an employee's last shift prior to (1) the  
7 employee's furlough days (weekends) or (2) pre-approved leave of a full day or more in duration. If  
8 an employee volunteers to work overtime as an extension to the last shift prior to their furlough days,  
9 and it relieves another employee from working mandatory overtime, it will count as mandatory  
10 overtime for the volunteer for the purposes of the ten (10) day wheel.

11 **C. Release from Mandatory Overtime.** Whenever possible, employees shall be  
12 relieved from their mandatory overtime shifts in order of reverse mandatory (the last person  
13 mandatoried shall be the first eligible to be relieved).

14 **D.** Any employee required to work mandatory overtime within ten (10) days of  
15 previously working mandatory overtime shall be paid double time for such mandatory overtime hours  
16 worked within ten (10) days of previous mandatory overtime.

17 **E. Tapping and Mandatory Overtime Out of Seniority Order.** The parties agree  
18 that tapping is an undesirable, but, on occasion, a necessary practice. By agreeing to this Tapping  
19 Rule the parties do not intend to increase the occasions on which employees are tapped. Unless an  
20 employee is given oral or written notice prior to being relieved from duty (having left their post, or if  
21 not assigned to a post, left their assigned work area or their shift starting-ending floor at the end of  
22 their shift) that they may be held over to work mandatory overtime, the employee shall generally not  
23 be required to work mandatory overtime even if the employee is still within the facility. When  
24 Tapping is necessary, or when an employee is required to work mandatory overtime out of seniority  
25 order, the employee will be paid an additional one-half time over and above the rate otherwise  
26 required by this Agreement. Information on the occurrences of tapping will be available to the Guild

1 upon request. Employees given notice of a potential holdover are required to check in for mandatory  
2 overtime before leaving the facility. Management will notify a reasonable number of employees of  
3 possible mandatory overtime as early in the shift as possible.

4 **F. Mandatory Overtime Passes.** Each employee will be entitled to use up to two (2)  
5 passes per calendar year when their name comes up next on the mandatory overtime list. This section  
6 provides an opportunity for the employee to use up to two (2) passes per calendar year, but does not  
7 guarantee that any requested pass will be allowed for the shift requested. Passes will be allowed on  
8 the following basis:

- 9 1. No more than two (2) passes may be used on any one (1) shift, on a seniority  
10 basis.
- 11 2. Use of a pass must be requested at the time of notification of mandatory  
12 overtime, and the Captain will determine eligibility, no requests for passes will  
13 be accepted after the schedule has been set by the Captain.
- 14 3. Passes may not be used on designated County holidays.
- 15 4. Passes may not be used if the resulting bump down causes another employee to  
16 be placed on mandatory overtime for a second time in a 10-day period.
- 17 5. Passes may be denied if a shift commander deems an emergency requiring all  
18 available officers.
- 19 6. Grievances of this sub-section shall be limited to Step 3 of the grievance  
20 procedure.

21 **G.** Employees working second shift shall not be required to work overtime pursuant to  
22 this Article on the third shift the day before going on annual Military Leave in accordance with  
23 Article 12.7.

24 **H. Mandatory on Furlough.** An employee who works a voluntary overtime shift on  
25 their furlough day shall not be required to work mandatory overtime on the shift immediately  
26 following.

1           **Section 9.13. Cancellation of Overtime.** Employees shall provide at least eight (8) hours of  
2 notice before cancelling their scheduled voluntary overtime shifts, with reasonable exceptions on a  
3 case by case basis. Cancellation of more than three (3) scheduled overtime shifts in a two (2) week  
4 period may result in an employee’s removal from the voluntary overtime list for a reasonable period  
5 not to exceed thirty (30) calendar days.

6           **Section 9.14. Court Appearances.** The following subsections depict the minimum  
7 compensation for court appearances, pretrial hearings, or conferences. Any additional time beyond  
8 the minimums will be compensated at the overtime rate, as appropriate, consistent with other  
9 provisions in this Article.

10           **A.** If the session starts less than two (2) hours before or after the shift, it will be  
11 considered a shift extension for court. Officers/Sergeants will be compensated for the amount of time  
12 spent before or after their shift.

13           **B.** If a session starts two (2) or more hours before or after the shift, compensation will  
14 be for a minimum of four (4) hours at time-and-one-half (1-1/2 X) their Base Rate.

15           **C.** Officers/Sergeants on scheduled furlough and subpoenaed for court or called in for  
16 court-related hearings, shall receive a minimum of four (4) hours overtime at the rate of time-and-  
17 one-half (1-1/2 X) their Base Rate.

18           **D.** Officers/Sergeants who are called in for court while on their vacation shall be  
19 placed on a regular, i.e., straight time, pay status and compensated for a full day’s pay. In addition,  
20 their vacation accrual shall be credited with an additional vacation day.

21           **Section 9.15. Mileage Reimbursement for Court.** The current King County mileage rate  
22 will not be paid for attendance at King County Courts.

23           **Section 9.16. Workweek Definition.** For the purpose of calculating FLSA overtime  
24 compensation, the seven (7) day FLSA 7(k) work period shall begin at 12:00 a.m. on Saturday of  
25 each week and continue for a total of seven (7) consecutive days through 11:59:59 p.m. the following  
26 Friday.

1           **Section 9.17. Compensatory Time Plan.** In lieu of overtime pay, an employee may request,  
2 in writing, compensatory time at the appropriate rate (straight-time, time-and-one half, or double-  
3 time) for each hour of overtime that was worked, provided: all compensatory time use must be  
4 authorized by Department management. Under normal conditions the following conditions will  
5 apply to the use of compensatory time:

6           **A.** Each bargaining unit employee may accrue (earn) a maximum of eighty-two (82)  
7 hours of compensatory time each year from any mix of voluntary or mandatory overtime. After that  
8 82 hour maximum has been reached, each bargaining unit employee may continue to accrue  
9 compensatory time in that year, but only for voluntary overtime, up to a maximum of one hundred  
10 and twenty-two (122) hours. Compensatory time carries over from year to year, but an employee with  
11 122 hours in their compensatory time bank at any time, regardless of when that that time was earned,  
12 must take overtime compensation in cash, rather than in compensatory time, until the account comes  
13 down below 122 hours.

14           **B.** Employees will not be allowed to use compensatory time if their unit is below  
15 minimum staffing and their absence must be covered by calling another employee in on overtime.

16           **C.** Accrued compensatory time may be paid off at the discretion of management.

17           **D.** The County will provide accrued leave balances on paychecks.

18           **E.** With respect to the scheduling of compensatory time:

19                   **1.** The scheduling of compensatory time on a legal holiday or contract holiday  
20 is unduly burdensome and disruptive (under the FLSA) to the County’s operation, and;

21                   **2.** The scheduling of compensatory time that is requested less than five (5)  
22 days in advance of the requested time is unduly burdensome and disruptive (under the FLSA) to  
23 County operations.

24           **F.** Management’s decisions in the application or granting of compensatory time shall  
25 not be subject to the provisions of Article 13, Grievance Procedure.

26           **Section 9.18. Daylight Savings Adjustment.** The Department will pay one (1) hour of

1 overtime to all employees working a nine (9) hour shift during the fall daylight saving adjustment  
2 period. Employees working during the spring daylight saving time adjustment period will either take  
3 one (1) hour of vacation or compensatory time, or one hour of leave without pay, to cover the  
4 reduction of their shift from eight (8) hours to seven (7).

5  
6  
7  
8  
9  
10  
11  
12  
13  
14  
15  
16  
17  
18  
19  
20  
21  
22  
23  
24  
25  
26  
27  
28

1 **ARTICLE 10: HOURS OF WORK**

2 **Section 10.1. Hours of Work.** The working hours of full-time Corrections Officers and  
3 Corrections Sergeants shall be equivalent to forty (40) hours and fifty (50) minutes per week (except  
4 for those who are assigned to work 4/10's that total 40 hours and 40 minutes per week); provided that  
5 for the purposes of the FLSA work period, the work period shall be seven (7) days pursuant to a 7(k)  
6 exemption.

7 **Section 10.2. Assignment of Work Schedules.** Except as otherwise provided in Article 9  
8 and Article 10, Section 10.3, the establishment of reasonable work schedules and starting times is  
9 vested solely within the purview of Department management and may be changed from time to time  
10 provided a two (2) week notice of change is given (or the employee voluntarily waives the notice  
11 period), except in those circumstances over which the Department cannot exercise control. The  
12 required two (2) week notification period shall not commence until the employee has received the  
13 written notification (includes email) of the proposed change (or the employee voluntarily waives the  
14 notice period. All such schedule changes (either with a notice period or with the employee waiving  
15 the notice period) shall be accompanied with the Guild receiving notice of such change. In the  
16 exercise of this prerogative, Department management will establish schedules to meet the dictates of  
17 the workload, however, nothing contained herein will permit split shifts.

18 **Section 10.3. Schedule Changes Due to Training.** When it becomes necessary to alter  
19 work schedules due to training, the Department shall be required to provide two (2) week's notice as  
20 provided in Section 10.2, except in emergency, extraordinary or unforeseen circumstances. In the  
21 event proper notice is not given, the affected employee shall have the option of refusing to attend the  
22 training.

23 **Section 10.4. Rest and Meal Periods.** There shall be provided to each on-duty employee, at  
24 employer expense, two fifteen (15) minute rest periods, inclusive of travel time, and a thirty (30)  
25 minute meal break per shift, during which time the employee shall remain available for duty. One (1)  
26 rest period shall be provided after approximately two (2) hours of the shift have elapsed, the other

1 after approximately six (6) shift hours have elapsed. The meal break and meal shall be provided at  
2 the approximate midpoint of the shift.

3 Employees are paid for the meal period and may be required to work during the meal period.  
4 Employees shall be provided with meals when on-duty and assigned to work at the KCCF or MRJC.  
5 Employees shall be entitled to up to a \$9.50 food stipend or voucher when required to work hospital  
6 guard duty or transport assignments which occur during their regularly scheduled meal period, per  
7 current practice. For travel outside of King County, employees shall be reimbursed for meals and  
8 expenses as authorized by King County's "Authorized Travel, Meal, and Expense Reimbursement for  
9 County Employees" policy, as amended.

10 Management and the Guild will meet at least on an annual basis with the Food Services  
11 Manager to review the food program and implement any committee approved changes. There may  
12 be other participants included upon mutual agreement such as Health Initiative Representatives,  
13 dietician, etc.

14 **Section 10.5. Roll Call.** Corrections Officers and Sergeants will be required to report to  
15 work ten (10) minutes prior to the hour, or half-hour, as scheduled, for briefing, and such time is to be  
16 part of the daily work shift and compensated by the negotiated base wage rate. The County will limit  
17 the roll call to 5 minutes to allow Officers travel time to their duty assignments.

18 **Section 10.6. Holiday and Weekend Court Coverage.** Employees who work on a holiday  
19 will be paid one and one-half times (1 1/2X) their Base Rate only for hours worked on a holiday.

20 **A.** When employees work a holiday court, they will have the option of working the  
21 shift to complete their 8.17 hours even if no slot is available or choose to take leave. If an employee  
22 chooses to stay, they are required to report to the shift commander for assignment.

23 **B.** Employees are allowed the option of starting their shift when the court assignment  
24 starts instead of their regular court detail assign start time. Employees can finish their 8.17 hours  
25 with leave or be available for shift coverage.

26 **C.** When employees work a holiday court that has a shift start earlier than their normal

1 start time, the holiday court shall be considered the start of their 8.17 hours for that day.

2 **D.** Weekend court will be treated as a call-out with a corresponding minimum of four  
3 (4) hours.

4

5

6

7

8

9

10

11

12

13

14

15

16

17

18

19

20

21

22

23

24

25

26

27

28



1 **ARTICLE 11: MEDICAL, DENTAL, AND LIFE INSURANCE PROGRAMS**

2 King County presently offers insured medical, dental, vision, accidental death and dismemberment,  
3 long-term disability and life insurance programs. The plan designs and plan features for the insured  
4 benefits are negotiated by the Joint Labor Management Insurance Committee (JLMIC), comprised of  
5 representatives of the County and labor organizations, on behalf of JLMIC-Eligible employees  
6 including the Guild. The Guild participates on the JLMIC, and adopts all terms and conditions of any  
7 JLMIC Agreements.

8

9

10

11

12

13

14

15

16

17

18

19

20

21

22

23

24

25

26

27

28

1 **ARTICLE 12: MISCELLANEOUS**

2 **Section 12.1. Mileage Reimbursement.** All employees who have been authorized by  
3 management to use their own transportation on King County business shall be reimbursed at the rate  
4 approved by ordinance by the King County Council.

5 **Section 12.2. Uniforms.**

6 **A.** Employees who suffer a loss or damage to personal property and/or personal  
7 clothing worn on the body in the line of duty will have same repaired or replaced at Department  
8 expense, not to exceed one hundred fifty dollars (\$150.00). Any jacket or uniform item damaged in  
9 the line of duty (not normal wear and tear) shall be repaired or replaced by the Department upon  
10 submission of the damaged uniform item (including any hazardous waste/blood stains). Employees  
11 may select the style of jacket (light weight or heavy) that will serve as the replacement jacket. The  
12 Department has the right to change any or all of the uniforms worn by its employees.

13 **B.** Employees shall be furnished an annual voucher to be used by the end of each  
14 calendar year. The voucher allows the employee to select and receive two uniforms from the County  
15 contract list including two (2) shirts, two (2) pairs of pants, one (1) pair of boots/shoes, one (1) belt,  
16 one (1) tie, one (1) tie clip and associated tailoring and patches. Employees may exchange voucher  
17 items for the items of the approved County list in accordance with Appendix 2, which shall be  
18 negotiated on an annual basis, beginning in October, by members of the Labor-Management group.  
19 In April of each year, employees will also be given four hundred fifty dollars (\$450.00), before  
20 appropriate individual payroll taxes, for the purpose of maintenance.

21 **C.** Employees shall be responsible for wearing only authorized uniforms in  
22 appropriate condition. Employees who experience a need for adjustments or additional purchases  
23 based on change in clothing size due to pregnancy or twenty-five (25) pounds or greater weight loss  
24 shall have their uniform replaced upon submission of the non-fitting uniform as long as that uniform  
25 is still in wearable condition.

26 **D.** Any uniform replacement as outlined above shall first be accomplished by

1 utilizing existing inventory before a new purchase is made.

2           **E.** Employees assigned to the Internal Investigations Unit and the Special  
3 Investigations Unit shall have the option of the above voucher and maintenance provision or in lieu  
4 of the above voucher and maintenance provision shall receive six hundred dollars (\$600.00), before  
5 appropriate individual payroll taxes, for the purchase and maintenance of authorized appropriate  
6 clothing. This election shall be made for each year of the assignment. Management maintains the  
7 ability to determine the appropriate clothing required for such special assignments.

8           **Section 12.3. Transitional Duty.** Employees who are injured and temporarily disabled may  
9 be allowed to work in a “transitional duty” status, if possible, while recuperating from such injury,  
10 provided said “transitional duty” must be approved by the Facility Commander and, provided further,  
11 that all provisions of King County Policy PER-22-6 (AEP), “Transitional Duty for Employees with  
12 Temporary Medical Restrictions” shall apply. Transitional duty shall consist of “restricted duty” and  
13 “alternative duty”. Restricted duty consists of the short-term elimination of job functions the  
14 employee is unable to perform due to temporary medical restrictions. Alternative duty consists of  
15 duties that are not part of the employee’s regular body of work. No bargaining unit posts or special  
16 assignments shall be available for assignment to any employee other than Corrections Officers or  
17 Sergeants.

18           **Section 12.4. Promotional Examinations.** The County will adhere to the King County  
19 Personnel Guidelines when conducting promotional examinations within the Corrections bargaining  
20 unit and the County will consult and confer with a Department joint labor/management committee to  
21 develop promotional exams within the Guild’s bargaining unit.

22           **Section 12.5. Employee Files.** Any/all employee files, except the “background” file, shall be  
23 available for review by the employee upon request during normal business hours. No information  
24 will be placed in the employee’s personnel file without the employee’s prior knowledge. Employees  
25 shall be allowed to make written responses to any materials which are in their personnel files, and  
26 such responses shall be maintained in their personnel files. Employees shall have the right to

1 examine and receive a photocopy of any part of their personnel file upon request during normal  
2 business hours. Access to an employee's personnel file by non-departmental employees shall be  
3 recorded and included in the personnel file.

4 All medical records and psychological evaluations shall be kept in separate files as required  
5 by law. Records related to internal investigations and/or criminal investigations shall be kept in  
6 separate files in accordance with Department policy.

7 **Section 12.6. Jury Duty.**

8 A. An employee required by law to serve on jury duty shall continue to receive salary  
9 and shall be relieved of regular duties for the period of time so assigned to jury duty. The fees,  
10 exclusive of mileage, paid by the Court for jury duty shall be forwarded to the financial manager for  
11 the Department of Adult and Juvenile Detention.

12 B. When an employee is notified to serve on jury duty, they will inform the  
13 Administrative Sergeant as soon as possible, but not later than two (2) weeks in advance, regarding  
14 the dates of absence from regular duties. The Administrative Sergeant will ensure that the employee  
15 is relieved of regular duties a minimum of sixteen (16) hours prior to the time of reporting for jury  
16 duty and will reassign the employee to the 1st shift, with Sunday/Saturday furloughs for the week(s)  
17 assigned to jury duty.

18 C. When released by the Court for the day, and/or when the total required assignment  
19 to jury duty has expired, the employee will report to the 1st Shift Commander for either assignment  
20 to 1st Shift or Court Detail until they should return to normal shift and furloughs, provided: there  
21 must be a minimum of sixteen (16) hours between the time the employee is dismissed from jury duty  
22 and the time they must report to normal shift and furloughs.

23 **Section 12.7. Military Leave.** The Department will adhere to all federal laws and  
24 regulations concerning military leave. However, the employee has the obligation to notify the  
25 Department, at the earliest possible date, regarding military service and training. Employees are  
26 required to submit to the Department a copy of all applications for military training, simultaneous

1 with the employee's submittal of the application to the military. Employees are expected to provide  
2 the Department with the dates of weekend drills and other scheduled periods of military service as  
3 soon as the employee is notified of such dates. Failure to comply with the Department's notification  
4 procedures may result in discipline or in denial of the requested leave, unless prohibited by federal or  
5 state law.

6 **Section 12.8. Language Translation.** Employees who translate a language in the workplace  
7 identified by management as a language for which translation activity is necessary shall be paid five  
8 hundred dollars (\$500) per year, pro-rated into equal per pay period installments. Eligible employees  
9 shall be required to pass a language proficiency test administered by the County. The County retains  
10 the discretion to determine the number of employees that may qualify for the premium.

11 **Section 12.9. Resignations.** The process for submitting and updating notices of resignations  
12 by employees shall be as follows: The employee provides notice of resignation (via officer report,  
13 County termination form or other means). The Department will acknowledge receipt and acceptance  
14 of the resignation in writing (email will suffice). When the receipt and acceptance has been sent, the  
15 employee will no longer have a right to rescind the resignation, but any request to extend or rescind  
16 will be treated as a request for reinstatement under reinstatement standards as set out in the County  
17 Personnel Guidelines. provided, the Department shall not disapprove an extension of resignation date  
18 or a reinstatement when such is requested for the sole purpose of meeting Department of Retirement  
19 Services (DRS) service requirements for eligibility for retirement, unless just cause exists to do so.

20 **Section 12.10. Fitness for Duty.** Once the Department has determined that a physical or  
21 psychological capacities evaluation should occur, any relevant medical history of the employee shall  
22 be provided to the examining professional. The examining professional shall issue a written report to  
23 the County, as the client, provided however, the employee shall have the right to receive a copy of  
24 that report. If the employee believes the conclusion of the examining professional is in error, the  
25 employee may obtain an additional examination at their own expense. The County will provide the  
26 employee's examining professional with documents which were utilized by the County's examining

1 professional. Upon proper written request of the employee, the County shall release the examination  
2 and supporting documents upon which it relies. All time and travel associated with said evaluation(s)  
3 shall be paid by the County.

4 **Section 12.11. Home Free Guarantee.** The Department agrees to continue to supplement  
5 the King County Home Free Guarantee program for any “free rides home” over the County-provided  
6 eight (8) that are a direct result of mandatory overtime. Employees living outside the coverage area  
7 of the King County Home Free Guarantee program shall be reimbursed by the Department for up to  
8 fifty dollars (\$50) per occurrence for any required travel as a direct result of mandatory overtime.

9 **Section 12.12. Mobility Devices.** Officers using crutches and/or canes shall be limited to  
10 using elevator #1 in Seattle. Officers using crutches and/or canes shall not move into the elevator #1  
11 Sally until it is secured. Officers may use crutches and/or canes while working in the floor control  
12 rooms at KCCF; provided they have met the necessary review by their healthcare provider and have  
13 filed a completed Essential Functions Form with the Department’s Human Resources Office.  
14 Officers are permitted to work with crutches and/or canes at the MRJC if there is a reasonable way to  
15 protect the environment of the officers moving between the Roll Call Room and the Housing and  
16 Central Control Rooms and have met the necessary review by their healthcare provider and have filed  
17 a completed Essential Functions Form with the Department’s Human Resources Office.

18 **Section 12.13. Policies and Procedures.** All policies, procedures, post orders and general  
19 directives and/or general memoranda shall be posted and/or stored on the Department Intranet and/or  
20 in Department electronic file folders and/or maintained in an accessible “roll call binder.” Employees  
21 are responsible for understanding and being aware of all such policies, procedures, orders, directives  
22 and memoranda. Any such policies, procedures, orders, directives and memoranda that are not  
23 posted and/or stored within forty-five (45) days of issuance may not be used as the sole sources of  
24 discipline for an employee failing to comply.

25 **Section 12.14. Probationary Period.** All newly hired and promoted employees must serve a  
26 probationary period. The probationary period is an extension of the hiring process. Sergeants who

1 are released from probation shall bump back to Corrections Officer.

2           **Section 12.15. Acceptable Use of Information Assets.** Pursuant to Memorandums of  
3 Agreement (MOAs) 295U0209 and 000U0108, all employees are to adhere to all County Policy  
4 concerning Acceptable Use of Information Technology Assets.

5           **Section 12.16. Employee Notification.** The County shall acknowledge receipt of an  
6 employee’s request for training, specialty assignment, or promotion within five (5) working days.  
7 The County shall notify employees as to approval or not of training requests generally within thirty  
8 (30) working days of the request.

9

10

11

12

13

14

15

16

17

18

19

20

21

22

23

24

25

26

27

28

1 **ARTICLE 13: GRIEVANCE PROCEDURE**

2           **Section 13.1. Definition.** Grievance - a dispute as to the interpretation or application of an  
3 express term of this Agreement. Written reprimands are not subject to Step 4 of the grievance  
4 procedure outlined in this Article.

5           **Section 13.2. Procedure.**

6                   **Step 1 - Major:** A grievance shall be presented in writing by the aggrieved employee  
7 and their representative, including but not limited to the legal advisor and/or shift representative if the  
8 employee wishes, within sixteen (16) calendar days of the occurrence of such grievance, to the Major  
9 for investigation, discussion, and written reply. This timeline is based on the agreement that  
10 disciplinary actions shall be e-mailed to both the Guild President/designee and Legal Advisor, and  
11 timelines start based on such e-mail date. The Major shall make their written decision available to  
12 the aggrieved employee within twenty (20) working days. If the grievance is not resolved, it shall be  
13 advanced to the next step in the grievance process within ten (10) working days.

14                   **Step 2 - Department Director:** If after thorough evaluation, the decision of the Major  
15 has not resolved the grievance to the satisfaction of the employee, the grievance may be presented to  
16 the Department Director or designee. All letters, memoranda, and other written materials previously  
17 submitted to the Major shall be made available for the review and consideration of the Department  
18 Director or designee. They may interview the employee and/or their representative and receive any  
19 additional related evidence which they may deem pertinent to the grievance. The Director or  
20 designee shall make their written decision available within twenty (20) working days. If the  
21 grievance is not resolved, it shall be advanced to the next step in the grievance process within ten (10)  
22 working days.

23                   **Step 3 - Labor Relations:** If the decision of the Department Director has not resolved  
24 the grievance, the grievance may be presented to the Office of Labor Relations, which shall render a  
25 decision on the grievance within twenty (20) working days.

26                   **Step 4 - Request for Arbitration:** Either the County or the Guild may request



1 arbitration within thirty (30) days of conclusion of Step 3, and must specify the exact question which  
2 it wishes arbitrated. The parties shall then select a third disinterested party to serve as an arbitrator.  
3 In the event that the parties are unable to agree upon an arbitrator, then the arbitrator shall be selected  
4 from a panel of nine (9) arbitrators furnished by the PERC. The arbitrator will be selected from the  
5 list by both the County representative and the Guild, each alternately striking a name from the list  
6 until one name remains. The arbitrator, who shall conduct the arbitration in accordance with the  
7 voluntary rules for labor arbitration, shall be asked to render a decision in accordance with those rules  
8 and the decision of the arbitrator shall be final and binding on both parties. The Parties shall bear the  
9 cost of their own attorneys' fees and costs, regardless of the outcome of the arbitration.

10 The arbitrator shall have no power to change, alter, detract from or add to, the provisions of  
11 this Agreement, but shall have the power only to apply and interpret the provisions of this Agreement  
12 in reaching a decision.

13 The arbitrator's fee and expenses shall be borne equally by both parties. Each party shall bear  
14 the cost of any non-employee witnesses appearing on that party's behalf.

15 No matter may be arbitrated which the County by law has no authority over, or has no  
16 authority to change.

17 **Section 13.3. Timelines.** Time restrictions may be waived or extended by consent of both  
18 parties.

19 **Section 13.4. Alternative Dispute Resolutions.**

20 **A. Unfair Labor Practice.** The parties agree that thirty (30) days prior to filing an  
21 unfair labor practice charge with the PERC, the complaining party will notify the other party, in  
22 writing, meet, and attempt to resolve the matter unless the deadline for filing with the PERC would  
23 otherwise pass or the complaining party is seeking a temporary restraining order as relief.

24 **B. Mediation.** Either party may request mediation following a Step 3 response that  
25 does not resolve the grievance (or after Step 2 for a grievance over discipline). Should both parties  
26 agree, they will meet with a mediator and try to resolve the grievance. In the event that the grievance

1 is not resolved, the Guild will have thirty (30) calendar days from the close of the mediation session  
2 in which to submit a written request for arbitration to the Director of the Office of Labor Relations.

3       **Section 13.5. Letters of Corrective Counseling.** Letters of corrective counseling are not  
4 examples of discipline. An employee who receives a letter of corrective counseling may, within five  
5 (5) days of receipt of the letter, request a meeting with the author to discuss the letter. If the  
6 employee chooses, they may request to have the meeting with the next higher in command. Within  
7 ten (10) days of such meeting, the author will notify the employee of whether or not the letter of  
8 corrective counseling will stand as is, be modified, or be rescinded. This appeal shall be limited to  
9 either the author or the next higher in command. The decision after this appeal shall be final. The  
10 letter shall be removed from all files and shall not be considered for any reason one (1) year after the  
11 incident giving rise to the letter of corrective counseling, provided no further incidents of similar  
12 conduct have occurred, provided further that should the letter concern harassment or discrimination,  
13 the employee must request removal after one (1) year and such requests shall not be unreasonably  
14 denied.

15       **Section 13.6. Multiple Procedures.** If employees have access to multiple procedures for  
16 adjudicating grievances, the selection by the employee of one procedure will preclude access to other  
17 procedures; selection is to be made no later than at the conclusion of Step 2 of this grievance  
18 procedure.

19       **Section 13.7. Just Cause/Progressive Discipline.** No employee may be discharged,  
20 suspended without pay, or disciplined in any way except for just cause, provided that other provisions  
21 in this contract may modify this provision. Just cause shall be defined as cause which is based upon  
22 reasonable grounds and must be a fair and honest cause or reason, regulated by good faith. In  
23 addition, the County will employ the concept of progressive discipline in appropriate cases. The  
24 County's policy is that discipline is corrective, rather than punitive in nature. It is understood that  
25 there may be egregious cases that result in discharge, disciplinary transfer or other disciplinary action  
26 that do not require corrective action.

1           **Section 13.8. Probationary Employees.** Grievances involving issues other than discharge  
2 of a probationary officer or demotion of a probationary sergeant may be processed in accordance with  
3 this article.

4  
5  
6  
7  
8  
9  
10  
11  
12  
13  
14  
15  
16  
17  
18  
19  
20  
21  
22  
23  
24  
25  
26

1 **ARTICLE 14: FURLOUGH AND SHIFT ASSIGNMENTS**

2           **Section 14.1. Request for Shift Change.** Employees who desire to change their current shift  
3 or furlough assignment may request the same by submitting a written request to their immediate  
4 supervisor.

5           **Section 14.2. Annual Rotation.** The Department will make all reasonable efforts to  
6 announce annual Facility/Shift/Furlough assignments not later than noon on the first Friday in  
7 December. Employees shall submit a shift request “Dream Sheet” at least fourteen (14) calendar  
8 days prior to the first Friday in December. The Department will provide employees with a “Dream  
9 Sheet” at least thirty (30) calendar days before they are required to submit the form. The shift request  
10 shall allow the employee to identify their preference for shift, furlough and facility of assignment, by  
11 using the 1-44 request concept.

12           All requests shall be considered, and a determination made on the basis of the operational  
13 needs of the Department, the seniority of the employee and their classification and previous furlough  
14 assignments, provided that all three preferences for furlough assignments submitted by a senior  
15 employee shall be considered prior to granting preference of a more junior employee.

16           The Department will make all reasonable efforts to perform the annual shift rotation on the  
17 last Saturday (or Sunday if that is the first day of the FLSA work week) in January.

18           All Shift 4 Corrections Sergeants must be gun qualified.

19           At management discretion, vacant posts, or additional post assignments required by changing  
20 circumstances and/or long term vacancies due to medical conditions, may be filled through temporary  
21 assignments of up to 120 days duration. These temporary assignments shall be posted for all eligible  
22 employees to make requests for, but assignment will be based on the needs of the Department.  
23 Employees on a transfer list shall have the first right of refusal of the temporary assignment. If no  
24 volunteers apply, the Department may assign based on inverse seniority. Employees assigned in this  
25 manner, whether voluntary or involuntary will be paid out of class pay for the duration of the  
26 assignment. This assignment will be done via “double-slotting,” where necessary.

1           **Section 14.3. Shift Changes Other Than Annual Rotation.** Requests for change at a time  
2 other than the annual rotation period (mini-rotations) shall be processed according to the provisions  
3 outlined in Attachment 1, "Transfer Request Procedures," originally agreed to by the parties April 11,  
4 2000. Mini-rotations shall occur a minimum of twice (2X) per year in the months of May and  
5 September. Additionally, during the month of July each year, employees shall be eligible for an on-  
6 shift adjustment (same shift and facility with different furloughs).

7           **Section 14.4. Management Decisions.** Management decisions regarding requests for shift  
8 change or furlough assignment shall not be subject to the grievance procedure beyond the  
9 Department Director level and the Director's decision shall be final.

10           **Section 14.5. Probationary Employees.** All probationary employees, either new hires or  
11 promotional, shall be subject to mandatory shift/assignment rotation during the probationary period.

12           **Section 14.6. Involuntary Transfers.** If an employee is transferred or reassigned  
13 involuntarily and such transfer or reassignment provides significant hardship on the employee or their  
14 family due to transportation problems, expense or other factors, the Department will give full  
15 consideration to these factors and respond to viable alternatives proposed by the employee or the  
16 Guild.

17           **Section 14.7. Special Assignments.** All special assignments shall be made at the discretion  
18 of management with seniority being but one factor. Advance notice of all special assignments shall  
19 be posted, and all interested Officers will be allowed to apply. Special assignments are defined as,  
20 but not limited to, any non-supervisory assignment, other than the normal rotating shift assignment;  
21 provided, however, that such assignment(s) shall not exceed three (3) years except in bona fide  
22 emergencies as determined by the Director. Sergeants assigned to IIU, SIU, or SOP shall be selected,  
23 at management's complete discretion, after an announced job posting. The employer may assign any  
24 employee to these assignments, whether or not the assigned employee has applied for the assignment.  
25 Assignments in IIU, SIU and SOP shall last for thirty-six (36) months and may be extended for up to  
26 an additional twenty-four (24) months. The time in IIU or SIU may be extended to three (3)

1 additional months if the assigned Sergeant is needed to complete an ongoing investigation. A  
2 Sergeant who has served in IIU or SIU may be temporarily reassigned to IIU or SIU at the  
3 employer's discretion.

4 **Section 14.8. Acting Shift Commander's Protocol.** Acting Shift Commanders shall be  
5 appointed to cover for an absent regular Shift Commander (Captain) on a shift-by-shift basis, when  
6 there is no other Captain available or when all available Captains have exercised the right of refusal  
7 to work the shift for the absent regular Shift Commander on overtime.

8 Consideration in the selection of Acting Shift Commanders shall first be given to regularly  
9 assigned Sergeants from the shift requiring an Acting Shift Commander and before Sergeants  
10 assigned from another shift; and the position shall be rotated giving equal opportunity to each  
11 regularly assigned Shift Sergeant on the affected shift.

12 Acting Shift Commanders shall be expected to perform the same duties as those of a regular  
13 Shift Commander.

14 **Section 14.9. Third Shift Weekend Shift Commander's Protocol.** The Guild retains the  
15 right to have the third shift Captain's position assigned in an acting capacity to a regularly assigned  
16 Sergeant when a Captain is not assigned (on either regular time or overtime). If a Sergeant is  
17 assigned as Acting Captain and no other Sergeants are assigned to the shift, a Corrections Officer will  
18 be assigned as an Acting Sergeant. This will ensure that a minimum of two (2) supervisors are on  
19 duty at all times. If an officer is mandatoried as a result of backfill due to this Agreement, that officer  
20 shall only be required to work for four (4) hours. At no time will a corrections officer be assigned in  
21 an Acting Captain capacity.

22 **Section 14.10. Conflicts of Interest Policy.** All employees shall adhere to the King County  
23 Employment Conflicts of Interest Policy, as amended, in accordance with MOA 295U0120.

24 **Section 14.11. Post Assignment Preference.** After the dream sheet process has been  
25 completed and Officers have been informed of their respective new shift and furlough selections, they  
26 will be provided with an opportunity to submit requests for consideration for their top two (2)

1 preferences for assignment. In order to be considered, these requests must be submitted within two  
2 (2) weeks of the announcement of the new schedules. The purpose of these requests is to provide a  
3 tool for officers to express their assignment preference directly to their supervisors. It is agreed  
4 between the parties that these requests for consideration are requests – there is no guarantee that  
5 Officers will receive either of their preferences.

6 The County agrees that when the initial assignments are being made, the preferences  
7 requested by the Officers will be given reasonable consideration. If an Officer does not receive either  
8 of their two (2) expressed preferences, they may request a written explanation. This request must be  
9 made in writing (e-mail is acceptable) and the Officer will receive an explanation in writing. It is  
10 agreed that the Shift Commander has the final say in regard to the assignment on the master schedule  
11 as well as on a day to day basis. The assignment decision cannot be grieved. The only issues subject  
12 to grievance are whether the original request was considered and whether or not a written explanation  
13 was provided to an employee who did not get assigned one of their preferences when they requested  
14 such an explanation.

1 **ARTICLE 15: FIREARMS**

2           **Section 15.1.** The Department will make available up to six hundred (600) rounds of practice  
3 ammunition annually for any Department authorized caliber weapons for each gun qualified  
4 corrections Officer/Sergeant, provided the Officer/Sergeant uses this ammunition at a range under  
5 supervised conditions. Gun qualified employees covered by this agreement shall be provided with  
6 ammunition appropriate to their weapon and consistent with Department policy.

7           **Section 15.2. Course of Fire.** The Department shall meet and confer with the Guild prior to  
8 any changes to the Course(s) of fire for gun qualification.

9           **Section 15.3. Vests.** The Department shall provide gun qualified employees with body  
10 armor of threat level IIIA, employees at their discretion may elect a level IIA vest. Vests shall be  
11 replaced whenever they are defective, but in no case longer than the manufacturer suggested  
12 replacement period.

13           **Section 15.4. Range Fee Reimbursement.** Gun qualified employees shall be reimbursed up  
14 to \$15 per month for range fees. Such reimbursement may also be made on an annual basis. In order  
15 to be eligible for reimbursement, the employee is required to submit a request accompanied by a  
16 receipt.

17  
18  
19  
20  
21  
22  
23  
24  
25  
26  
27



1 **ARTICLE 16: BULLETIN BOARDS**

2           **Section 16.1. Postings.** The County agrees to permit the Guild to post on County bulletin  
3 boards, the announcement of meetings, election of officers, and any other Guild material which is not  
4 prohibited by state law or County ordinance.

5           **Section 16.2. Job Announcements.** Job announcements will be posted on appropriate  
6 bulletin boards.

7

8

9

10

11

12

13

14

15

16

17

18

19

20

21

22

23

24

25

26

27

28

1 **ARTICLE 17: TRAINING AND EDUCATION REIMBURSEMENT**

2 **Section 17.1. Educational Reimbursement.** The County agrees to reimburse employees for  
3 the cost of tuition and books at an accredited institution for pre-approved degree work for any and all  
4 (e.g. Associates, Bachelors, Masters, PhD) degrees in criminal justice or public administration. The  
5 degree work will be reimbursed provided the employee receives a grade of “C” or better, or a passing  
6 grade if taken as pass/fail. These reimbursements shall be subject to the following conditions:

7 • The employee must have been employed by the Department for at least one full year  
8 prior to the reimbursement request.

9 • The individual must be pre-approved for the specific degree program and will only  
10 be reimbursed for necessary coursework or credits that are taken after approval.

11 • Reimbursement will be limited to an amount equal to the rate at the University of  
12 Washington.

13 • All requests for pre-approval shall be submitted to the Director with copies to the  
14 Facility Commander and Finance.

15 • Employees partially through a program may submit for pre-approval but shall only  
16 be reimbursed for any remaining necessary coursework or credits.

17 • All pre-approval requests must be submitted at least thirty (30) calendar days before  
18 the start of any coursework subject to reimbursement.

19 • Annual limit in accordance with IRS regulations (currently \$5,250.00).

20 Employees may submit for pre-approval for reimbursement as outlined above for degrees  
21 outside of Criminal Justice or Public Administration. This request shall be submitted to a standing  
22 panel of three members (two selected by management and one selected by the Guild) who shall  
23 review the request and make a recommendation to the Director. The Director shall make the final  
24 decision. The criteria to determine whether a degree program would be approved for reimbursement  
25 shall be whether or not the program has a direct relationship to the employee’s work and provides a  
26 corresponding benefit to the Department. The request shall be processed in the following manner:

1                   • The pre-approval request must be submitted at least sixty (60) calendar days before  
2 the start of any coursework subject to reimbursement.

3                   • The Panel shall convene within thirty (30) calendar days of the request to review the  
4 request - including an opportunity to meet with the employee to discuss the merits of their request.

5                   • The Panel shall make their recommendation to the Director in writing with the  
6 reasons for the recommendation within fourteen (14) calendar days of reviewing the request and shall  
7 provide a copy of the recommendation to the employee.

8                   • The Director shall make the final decision within fourteen (14) calendar days of  
9 receiving the recommendation. This decision shall be in writing and if denied, shall include reasons  
10 for the denial.

11 There shall be an annual limit of forty (40) employees who can receive tuition reimbursement during  
12 any calendar year.

13           **Section 17.2. Special Schools/Temporary Assignments.** Notice of special schools, training  
14 opportunities and temporary assignments will be posted, and all interested and qualified employees  
15 will be allowed to apply prior to selection of the candidate(s). Employees who request training shall  
16 be given written notification that their request has been received by the required person(s) upon  
17 receipt. A list of employees who have requested training shall be provided to the Guild upon request.  
18 The Department will consider the job performance, supervisory recommendations and special  
19 expertise in making its selection. Probationary employees shall not receive training slots where  
20 qualified regular employees have submitted application and been denied. The Director shall have  
21 final approval of all selections for special schools, training opportunities and temporary assignments  
22 and such decisions shall not be grievable beyond Step 2 (Department Director). A list of all  
23 employees selected for training will be posted on appropriate bulletin boards.

1 **ARTICLE 18: PAST PRACTICE**

2           The parties agree that this Agreement will constitute the whole and entire Agreement between  
3 the parties. Further, that any past practice which is not specifically and expressly contained within  
4 the terms of this Agreement will be considered abolished and will no longer be considered a  
5 precedent.

6

7

8

9

10

11

12

13

14

15

16

17

18

19

20

21

22

23

24

25

26

27

1 **ARTICLE 19: SAVINGS CLAUSE**

2           Should any part hereof or any provision herein contained be rendered or declared invalid by  
3 reason of any existing or subsequently enacted legislation or by any decree of a court of competent  
4 jurisdiction, such invalidation of such part or portion of this Agreement shall not invalidate the  
5 remaining portions hereof; provided, however, upon such invalidation the parties agree to meet and  
6 renegotiate such parts or provisions affected. The remaining parts or provisions shall remain in full  
7 force and effect.

8

9

10

11

12

13

14

15

16

17

18

19

20

21

22

23

24

25

26

27

28

1 **ARTICLE 20: WORK STOPPAGES AND EMPLOYER PROTECTION**

2           **Section 20.1. No Work Stoppage.** The County and the Guild agree that the public interest  
3 requires efficient and uninterrupted performance of all County services, and to this end, pledge their  
4 best efforts to avoid or eliminate any conduct contrary to this objective. Specifically, the Guild shall  
5 not cause or condone any work stoppage, including any strike, slowdown, or refusal to perform any  
6 customarily assigned duties, sick leave absence which is not bona fide, or other interference with  
7 County functions by employees under this Agreement and should same occur, the Guild agrees to  
8 take appropriate steps to end such interference. Any concerted action by any employees in the  
9 bargaining unit shall be deemed a work stoppage if any of the above activities have occurred.

10           **Section 20.2. Guild Responsibility.** Upon notification in writing by the County to the Guild  
11 that any of its members are engaged in a work stoppage, the Guild shall immediately, in writing,  
12 order such employee to immediately cease engaging in such work stoppage and provide the County  
13 with a copy of such order. In addition, if requested by the County, a responsible official of the Guild  
14 shall publicly order such employees to cease engaging in such a work stoppage.

15           **Section 20.3. Penalties.** Any employee who commits any act prohibited in this article will  
16 be subject to the following action or penalties:

- 17                   1. Discharge.
- 18                   2. Suspension or other disciplinary action as may be applicable to such employee.

1 **ARTICLE 21: WAIVER CLAUSE**

2           The parties acknowledge that each has had the unlimited right within the law and the  
3 opportunity to make demands and proposals with respect to any matter deemed a proper subject for  
4 collective bargaining. The results of the exercise of that right and opportunity are set forth in this  
5 Agreement. Therefore, the County and the signatory organization, for the duration of this  
6 Agreement, each agree to waive the right to oblige the other party to bargain with respect to any  
7 subject or matter not specifically referred to or covered in this Agreement.

8

9

10

11

12

13

14

15

16

17

18

19

20

21

22

23

24

25

26

27

28

1 **ARTICLE 22: REDUCTION-IN-FORCE**

2           **Section 22.1. Order of Layoff.** Employees laid off as a result of a reduction-in-force shall  
3 be laid off according to seniority within the classification, with the employee with the least time  
4 being the first to be laid off. Employees not scheduled to be laid off may request to be laid off out of  
5 seniority order and replace the most senior employee scheduled to be laid off. Ties in classification  
6 seniority shall be broken in accordance with the tiebreaker provisions outlined in Article 4, Section  
7 4.6.

8           **Section 22.2. Demotion in Lieu of Layoff.** In lieu of layoff, a regular or probationary  
9 employee within the bargaining unit may request, and shall be granted, demotion to a position in a  
10 lower classification formerly held by that employee within the bargaining unit, thereby filling the  
11 position (i.e., bumping) held by the employee with the least seniority in the lower classification;  
12 provided that the employee requesting demotion (i.e., exercising their right to bump) has more  
13 seniority in the bargaining unit than the employee who is being bumped (including tiebreakers as  
14 outlined in Article 4, Section 4.6).

15           **Section 22.3. Recall.** The names of laid off employees will be placed in inverse order of  
16 layoff on a Re-employment List for the classification previously occupied. The Re-employment List  
17 will remain in effect for a maximum of two years or until all laid off employees are rehired,  
18 whichever occurs first. As positions become available, employees on the Re-employment List will  
19 be given first opportunity to return to work. Those on the Re-employment List shall be responsible  
20 for providing current address and phone numbers to the County. After notice of recall, an employee  
21 will have two (2) weeks to respond to the notice of recall. An employee refusing a recall opportunity  
22 or failing to respond within two weeks shall be removed from the Re-employment List, unless  
23 affirmatively requesting to stay on the list. Employees who are recalled shall return to the same wage  
24 step and accrual levels they were at when they were laid off.

25           **Section 22.4. Layoff Notification.** The County will notify the affected employees at least  
26 thirty (30) calendar days in advance of the effective date of any layoff. When providing layoff



1 notification to affected employees, the Department shall provide and make available to the employee  
2 information about the County's Layoff and Recall program.

3  
4  
5  
6  
7  
8  
9  
10  
11  
12  
13  
14  
15  
16  
17  
18  
19  
20  
21  
22  
23  
24  
25  
26

1 **ARTICLE 23: EMPLOYEE BILL OF RIGHTS**

2 A. Every employee who becomes the subject of an internal investigation shall be advised at  
3 the time of the interview that they are suspected of:

- 4 1. Committing a criminal offense;  
5 2. Misconduct that would be grounds for termination, suspension, or other  
6 disciplinary action; or  
7 3. That they may not be qualified for continued employment with the Department.

8 B. Any employee who becomes the subject of a criminal investigation may have legal  
9 counsel present during all interviews. This representation by counsel is confined to counseling and  
10 not actual participation in the investigation. A criminal investigation as used herein shall be  
11 interpreted as any action which could result in the filing of a criminal charge. A major investigation  
12 as used elsewhere in this motion shall be interpreted as any action which could result in dismissal  
13 from the Department or the filing of a criminal charge.

14 C. The employee under investigation must at the time of the interview be informed of the  
15 name of the officer in charge of the investigation and the name of the officer who will be conducting  
16 the interview.

17 D. The employee shall be informed in writing of the nature of the major investigations and  
18 whether they are a witness or suspect before any interview commences, including information  
19 necessary to apprise them for the allegations of such complaints.

20 E. The interview of an employee shall be at a reasonable hour, preferably when the employee  
21 is on duty unless the exigencies of the interview dictate otherwise. Whenever possible, interviews  
22 shall be scheduled during the normal workday of the County.

23 F. The employee may request that a major investigation interview be recorded, either  
24 mechanically and/or by a stenographer. There can be no “off-the-record” questions. Upon request,  
25 the employee under a major investigation shall be provided an exact copy of any written statement  
26 they have signed or of a verbatim transcript of any interview.

1           **G.** Interviewing shall be completed within a reasonable time, and shall be done under  
2 circumstances devoid of intimidation or coercion. In all major investigation interviews the employee  
3 shall be afforded an opportunity and facilities to contact and consult privately with an attorney of  
4 their own choosing before being interviewed. The employee shall be entitled to such reasonable  
5 intermissions as they shall request for personal necessities, meals, telephone calls, and rest periods.

6           **H.** All interviewing shall be limited in scope to activities, circumstances, or events which  
7 pertain to the employee’s conduct or acts which may form the basis for disciplinary action under one  
8 or more of the categories contained in Paragraph 2 herein.

9           **I.** The employee will not be threatened with dismissal or other disciplinary punishment as a  
10 guide to attempt to obtain their resignation, nor shall they be subject to abusive or offensive language  
11 or intimidated in any other manner. No promises or rewards shall be made as an inducement to  
12 answer questions.

13           **J.** Administrative Investigations are intended to be concluded within 180 days from intake of  
14 the complaint. When an investigation must take longer than 180 days, the County will notify the  
15 Guild, and inform them of the reasons causing the delay in completion.

16  
17  
18  
19  
20  
21  
22  
23  
24  
25  
26  
27  
28

1 **ARTICLE 24: DURATION**

2 This Agreement and each of its provisions, unless otherwise stated, shall, upon ratification by  
3 the King County Council, become effective January 1, 2020 and shall continue in full force and effect  
4 through December 31, 2021.

5 Contract negotiations for the year 2022 may be initiated by either party by providing to the  
6 other party written notice of its desire to begin negotiations-

7  
8

9 **APPROVED** this \_\_\_\_\_ day of \_\_\_\_\_, 2020.

10  
11

12  
13 By: \_\_\_\_\_  
14 King County Executive

15  
16  
17

18 King County Corrections Guild:

19  
20

DocuSigned by:  
*Dennis Folk*  
7D59C6066F154E3...

21 \_\_\_\_\_  
Dennis Folk  
22 President

23  
24  
25  
26

## APPENDIX 1 - FIREARMS RE-QUALIFICATION

1  
2           1. Employees who have a legitimate reason to be excused from a semi-annual re-qualification  
3 session must document that reason, in writing, to their Division Major at least fourteen (14) days in  
4 advance of the re-qualification session. (Except employees on approved leave during the re-  
5 qualification period.) Employees requesting to be excused from a re-qualification session due to  
6 medical reasons not already known to the Department may be required to provide written verification  
7 in the form requested by the Department. In order to be cleared for re-qualification (or any  
8 subsequent make-up), the employee must be medically cleared to full duty (be able to be assigned to  
9 a gun post), provided that employees with an accepted workers compensation claim will be allowed  
10 to remain gun qualified, subject to the provisions below.

11           2. The requests to be excused will be reviewed by the Division Majors and other senior  
12 managers, if necessary. A list of those employees excused will be forwarded to the Firearms  
13 Instructors. Those not excused will be notified by the Division Majors and will be required to sign-  
14 up and attend the re-qualification session. Employees who are not excused from and fail to attend a  
15 semi-annual re-qualification session without a legitimate reason will be disciplined for failure to  
16 follow a directive and will not be allowed to participate in a make-up shoot. They will no longer be  
17 considered firearms qualified. They will no longer receive a firearms premium, will no longer show  
18 as weapons qualified in the Roster Management System (RMS), and will be required to turn in their  
19 Department-issued firearm(s) and related equipment.

20           3. Employees attending a semi-annual re-qualification session and failing to obtain a passing  
21 score will have the option of voluntarily turning in their Department-issued firearm(s) and related  
22 equipment. They will no longer be considered firearms qualified. They will no longer receive a  
23 firearms premium and will no longer show as weapons qualified in the RMS. However, if these  
24 employees choose, they will be offered a chance to obtain a passing score during a four-hour  
25 remedial class scheduled shortly after their re-qualification session. (They will not be assigned to  
26 carry a firearm during the intervening time period.) If they fail to obtain a passing score during the

1 re-qualification session and subsequent remedial class, they will no longer be considered firearms  
2 qualified. They will no longer receive a firearms premium and will no longer show as weapons  
3 qualified in the RMS. They will again have the option of voluntarily turning in their Department-  
4 issued firearm(s) and related equipment, with the stipulations above, or if they so choose, they will be  
5 allowed to attend the next regularly scheduled semi-annual re-qualification session. They will be  
6 allowed to retain their Department-issued firearm(s) and related equipment during this time period,  
7 and will be allowed to draw practice ammunition.

8       4. Employees who are excused from a semi-annual re-qualification session will be required to  
9 attend a make-up shoot to be scheduled by the Department, usually within thirty (30) days after the  
10 re-qualification session ends. This make-up shoot will be administered by no less than two  
11 Department Firearms Instructors. Employees who are unable to attend this make-up shoot will be  
12 permitted to retain their firearm(s) and equipment only if they have requested and been granted  
13 approval to be excused in advanced. See #3 above for the approval process.

14       5. Employees who are excused from the semi-annual re-qualification session and the make-  
15 up shoot for that session, or who fail to obtain a passing score during the make-up shoot, will have  
16 their firearms premium discontinued (subject to review on a case-by-case basis), will have the  
17 weapons-qualified attribute removed from their name in the RMS, and will not be allowed to work  
18 any firearms-required posts. These stipulations take effect on the date that the re-qualifications  
19 sessions end. They will be allowed to retain their Department-issued firearm(s) and related  
20 equipment and will be authorized to draw practice ammunition up until the next semi-annual re-  
21 qualification session, at which time they will be required to re-qualify. Employees who have an  
22 accepted workers compensation claim and are excused for medical reasons from the semi-annual  
23 requalification and the make-up shoot will remain gun qualified until the next requalification.

24 Employees missing two consecutive requalifications shall no longer be gun qualified. Employees  
25 who are excused for medical reasons from the semi-annual requalification and the make-up shoot as  
26 well as employees with a workers compensation claim missing two consecutive requalifications will

1 be allowed to fit into the existing schedule for a make-up shoot upon being fully cleared for duty.

2           **6.** Employees who are excused from a semi-annual re-qualification session and the  
3 subsequent make-up shoot, or fail to obtain a passing score during a semi-annual re-qualification  
4 session and subsequent make-up shoot, and then are unable to attend the next scheduled semi-annual  
5 re-qualification session for whatever reason, or fail to obtain a passing score during a second semi-  
6 annual re-qualification session, will no longer be considered firearms qualified. They will no longer  
7 receive a firearms premium, will no longer show as weapons qualified in the RMS, and will be  
8 required to turn in their Department-issued firearm(s) and related equipment. These employees will  
9 be required to apply for, and be approved to attend, a full Basic Firearms Training Course in order to  
10 again be firearms qualified. This provision does not apply to those employees with exceptional  
11 circumstances such as long-term active military duty, long-term approved medical leave, or other  
12 clearly extraordinary reasons for not attending the re-qualification sessions (see #7, below). These  
13 cases will be evaluated by the Division Majors and other senior managers and appropriate action  
14 taken.

15           **7.** Employees returning to full duty (after an extended leave or limited duty) who are no  
16 longer firearms qualified because they missed two consecutive re-qualification sessions will not be  
17 assigned to any firearms-required positions until they have obtained a passing score on the current  
18 Department re-qualification course. These employees will be required to attend a make-up shoot to  
19 be scheduled by the Department, usually within thirty (30) days of the employee's return to duty.  
20 This make-up shoot will be administered by no less than two Department Firearms Instructors. This  
21 make-up shoot will be treated as the employee's semi-annual re-qualification session and the  
22 employee will be subject to the guidelines outlined in Sections #3 and #4 above if a passing score is  
23 not obtained.

24           **8.** Numbers 2-7 above are illustrated on the attached Firearms Re-Qualification Flowchart.

25           **9.** Following each semi-annual re-qualification session, the senior Firearms Instructor will be  
26 responsible for ensuring that the names of employees who did not qualify (and the circumstances), or

1 who failed to attend the session are forwarded to the Division Majors. The names will be reviewed  
2 by the Division Majors and other senior managers and appropriate action taken.

3 **10.** Management will convey these changes to employees in the re-qualification notices.  
4  
5  
6  
7  
8  
9  
10  
11  
12  
13  
14  
15  
16  
17  
18  
19  
20  
21  
22  
23  
24  
25  
26



1  
2  
3  
4  
5  
6  
7  
8  
9  
10  
11  
12  
13  
14  
15  
16  
17  
18  
19  
20  
21  
22  
23  
24  
25  
26  
27  
28

**Appendix 1 - Firearms Re-Qualification Flowchart**

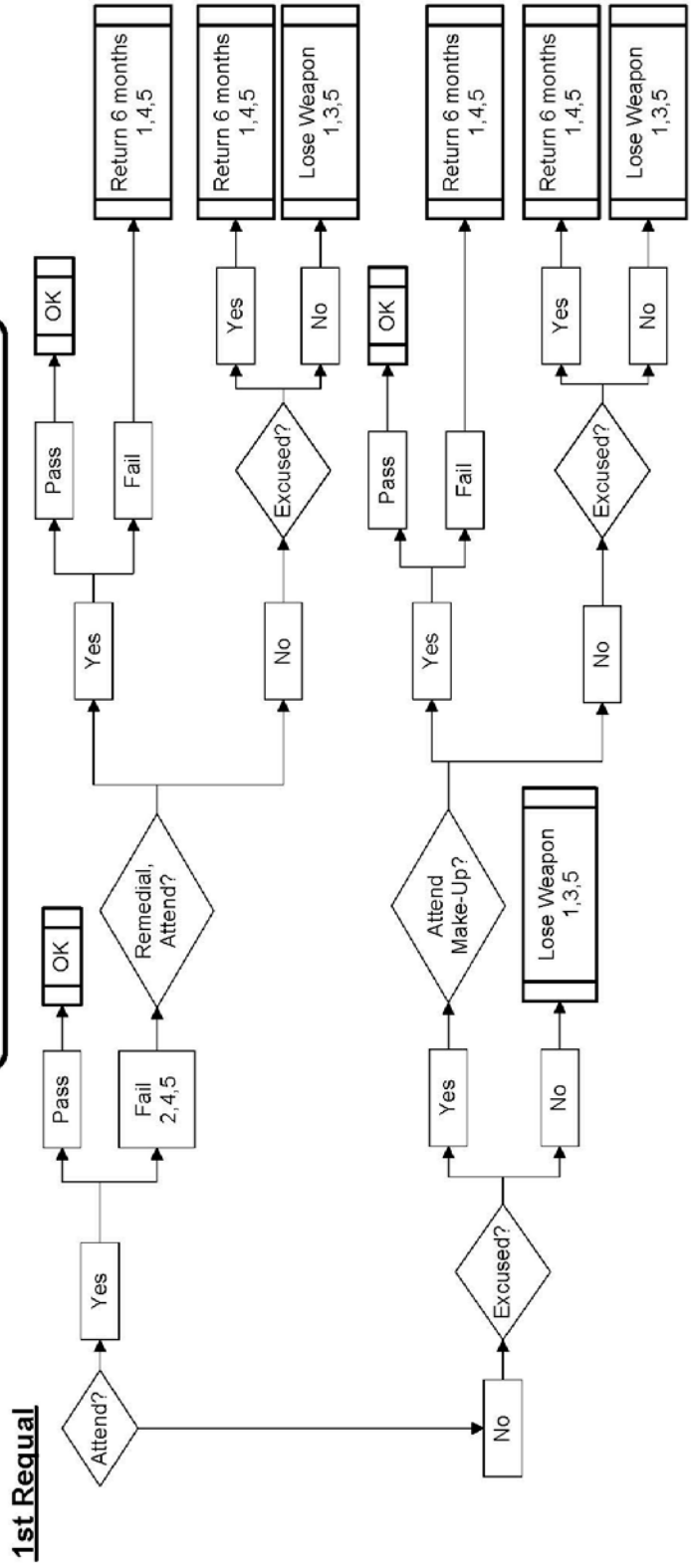

**2nd Consecutive Requal**

**Staff returning after extended absence or other reasons for not carrying a gun for an extended period.**  
 Requal or make-up shoot as determined by the Department  
 \_\_\_ Keep \$\$\$, no gun positions until offered the chance to shoot  
 \_\_\_ Make-up shoots will be treated as the shooter's "1st Requal" and will be subject to the guidelines listed above  
 1. Lose \$\$\$  
 2. Keep \$\$\$  
 3. Lose Gun  
 4. Keep Gun  
 5. No gun positions

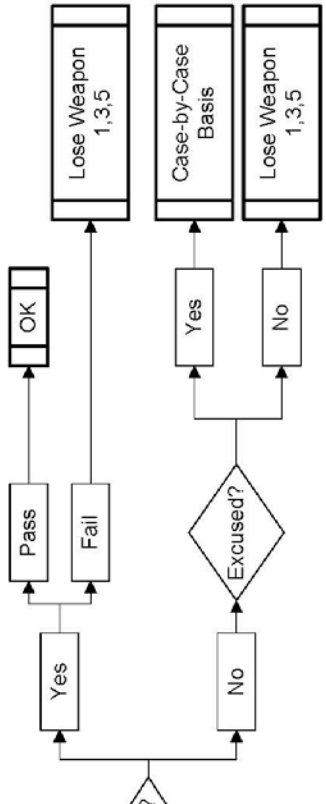

## APPENDIX 2 – UNIFORMS

## ADULT DIVISION APPROVED UNIFORMS AND EQUIPMENT

Blumenthal Part #	Description
<b>UNIFORM SHIRTS</b>	
<i>Horace Small Apparel Co.</i>	
HS1224	Men's Shirt, Short Sleeve #660DN, Polyester-Rayon Blend, Dark Navy
HS1126	Men's Shirt, Long Sleeve #520DN, Polyester-Rayon Blend, Dark Navy
HS1279	Women's Shirt, Short Sleeve #670DN, Polyester-Rayon Blend, Dark Navy
HS1178	Women's Shirt, Long Sleeve #530DN, Polyester-Rayon Blend, Dark Navy
ST52NV	Navy Long Sleeve Shirt
7M7SNV	Navy Academy Shirt
<i>Fechheimer</i>	
97R6686	Men's Shirt, Short Sleeve Deluxe Tropical, Dark Navy
47W6686	Men's Shirt, Long Sleeve Deluxe Tropical, Dark Navy
98R3986	Men's Shirt, Short Sleeve "Perfect Match", Dark Navy
48W3986	Men's Shirt, Long Sleeve "Perfect Match", Dark Navy
154R6686	Women's Shirt, Short Sleeve Deluxe Tropical, Dark Navy
104W6686	Women's Shirt, Long Sleeve Deluxe Tropical, Dark Navy
254R3986	Women's Shirt, Short Sleeve "Perfect Match", Dark Navy
	Women's Shirt, Long Sleeve "Perfect Match", Dark Navy
15W5400	Shirt, Long Sleeve, Poly-Cotton Blend, White
70R9586	Men's Shirt, Wool, Short Sleeve, Dark Navy
20W9586	Men's Shirt, Wool, Long Sleeve, Dark Navy
170R9586	Women's Shirt, Wool, Short Sleeve, Dark Navy
120W9586	Women's Shirt, Wool, Long Sleeve, Dark Navy
<i>Edwards Uniforms Co.</i>	
1212-01	Men's Shirt, Short Sleeve Flyer, Poly-Cotton Blend Light Blue
1262-01	Men's Shirt, Long Sleeve Flyer, Poly-Cotton Blend Light Blue
5212-01	Women's Shirt, Short Sleeve Flyer, Poly-Cotton Blend Light Blue
5262-01	Women's Shirt, Long Sleeve Flyer, Poly-Cotton Blend Light Blue
<i>5.11 Uniforms</i>	
71177-750	Men's Shirt, Short Sleeve, "PDU", Dark Navy
72345-750	Men's Shirt, Long Sleeve, "PDU", Dark Navy
61159-750	Women's Shirt, Short Sleeve, "PDU", Dark Navy

**ADULT DIVISION APPROVED UNIFORMS AND EQUIPMENT**

Blumenthal Part #	Description
62065-750	Women's Shirt, Long Sleeve, "PDU", Dark Navy

**UNIFORM PANTS**

<i>Horace Small Uniforms</i>	
HS2149	Navy Sentry (Honor Guard)
74003	New Academy Pant
<i>Fechheimer</i>	
32230	Men's Pants, Polyester Elastique, Dark Navy
TR070	Men's Pants, Polyester Elastique, Dark Navy
32260	Men's Pants, Dacron-Wool Blend, Dark Navy
39300	Men's Pants, "Perfect Match" Non-Cargo, Dark Navy
39400	Men's Pants, "Perfect Match" Cargo, Dark Navy
32289	Men's Pants, Wool, Dark Navy
32230W	Women's Pants, Polyester Elastique, Dark Navy
TR070W	Women's Pants, Polyester Elastique, Dark Navy
32260W	Women's Pants, Dacron-Wool Blend, Dark Navy
39300W	Women's Pants, "Perfect Match" Non-Cargo, Dark Navy
39400W	Women's Pants, "Perfect Match" Cargo, Dark Navy
32289W	Women's Pants, Wool, Dark Navy
<i>5.11 Uniforms</i>	
74326-750	Men's Pants, "PDU", Dark Navy
64306-750	Women's Pants, "PDU", Dark Navy

**UNIFORM COATS, JACKETS, SWEATERS AND WORK WEAR**

<i>Fechheimer</i>	
54100	Softshell Jacket, Black
<i>Blauer</i>	
9910Z	Cruiser Jacket, Gortex w/Liner and Gold "S" Buttons, Police Blue
<i>Fechheimer</i>	
SPDBLS02	Dress Coat, w/Gold "S" Buttons, Dark Navy
<i>Red Kap Industries **Or Approved Equal**</i>	
ST62NV	Work Shirt, Short Sleeve, Polyester-Cotton Twill, Navy
ST52NV	Work Shirt, Long Sleeve, Polyester-Cotton Twill, Navy

1	PT62NV	Work Pants, Polyester Cotton Twill, Navy
2		<b><i>Dickies Industrial Wear</i></b>
3	4879	Coverall, Poly-Cotton Blend, Navy

#### **HONOR GUARD APPAREL**

5		909 Sentry Dress Pant, Horace Small #HS2149, Dark Navy
6		1/2" Gold Braid Stripe for Pants
7		Tunic, Hope Uniforms #KINGCOADTUNIC, Dark Navy
8		Hat, Felt Campaign Style, Stratton Hats #F-40, Seville Blue
9		Gold Cord w/Acorns, Stratton Hats #CD-GD
10		Dress Gloves, White Dotted, Premier Emblem #P7013
11		Duty Belt w/Brass Buckle, Safariland #87-XX-9B, High-Gloss
12		Rain Cover f/Campaign Hat, Stratton Hats #RC-MP (129)
13		Case, Polymer, f/Campaign Hat, Hat Trap #HAT TRAP
14		Polo Jersey, Knit Cotton, Sanmar Corp. #K440
15		Trench Coat, "Newport Harbor" Darien Double Breasted #761MT Navy

#### **SHOES, BOOTS & ACCESSORIES**

16		<b><i>Under Armour</i></b>
17	3021034	Valsetz Boot, 7"
18	3021037	Women's Valsetz Boot, 7"
19		<b><i>Danner</i></b>
20	21210	Acadia
21	21210W	Women's Acadia
22	25200	Patrol, 6"
23	25200W	Women's Patrol, 6"
24		<b><i>Converse</i></b>
25	CP8101	Converse Men's Shoe
26	RB110	Converse Women's Shoe
27		<b><i>Thorogood</i></b>
28	834-6905	Oxford Shoe
29	834-6906	Chukka Boot
30	534-6905	Women's Oxford Shoe
31	534-6906	Women's Chukka Boot
32		<b><i>New Balance</i></b>
33	MK706BL	New Balance Oxford Shoe
34	MW928BK	New Balance Men's Shoe
35	WW928BK	New Balance Women's Shoe

1		<b>Rocky Shoes</b>
2	5000	Oxford
3	5001	Oxford
4	5005	Chukka Boot
5	5101	Women's Oxford
6		<b>5.11 Tactical</b>
7	12002-019	Boot, 6"
8	12004-019	ATTAC Boot, 6"
9	12018-019	Women's Boot, 6"
10	12025-019	Women's ATTAC Boot, 6"

### **HATS AND CAPS**

9	MI6064	Dress Hat, Superior Uniform Cap Co., LAPD Style w/Navy Elastic Band, 3 Eyelets **Or Approved Equal**
10	514	Baseball Cap, Richardson Sports, Wool w/Velcro Adjuster, Dark Navy **Or Approved Equal**
11	CP90	Knit Watch Cap, San Mar, Black w/Embroidered Department Logo **Or Approved Equal**

### **SOCKS, UNDERGARMENTS AND ATHLETIC WEAR**

14		<b>Sanmar **Or Approved Equal**</b>
15	5180	T-Shirt, Beefy-T, White
16	5180	T-Shirt, Beefy-T, White, with Heat-Stamped Lettering
17	9731M	Sweatpants w/Pocket, Dark Navy
18	PC90P	Sweatshirt, Crewneck, Dark Navy
19	ST310	Shorts, Dark Navy

### **BELTS AND INSIGNIA**

20		<b>Chambers Belt Company **Or Approved Equal**</b>
21	6605	Belt, Black Basket Weave, 1 1/2"
22	6606	Belt, Black Basket Weave, 1 3/4"
23		<b>Emblem Enterprises **Or Approved Equal**</b>
24	4490G	Insignia, 5/8" 1-Star, Gold
25	4470G	Collar Ornament, 1" 1-Star, Gold
26	4491G	Insignia, 5/8" 2-Stars, Gold
27	4471G	Collar Ornament, 1" 2-Stars, Gold
28	4492G	Insignia, 5/8" 3-Stars, Gold
29	4472G	Collar Ornament, 1" 3-Stars, Gold
30	4412MG	Insignia, Major Leaves, Small, Gold

1	4427PG	Collar Ornament, 1" Major Leaves, Gold
	4411MG	Insignia, Captain's Bars, Small, Gold
2	4426PG	Collar Ornament, 1" Captain's Bars, Gold
	4407MG	Collar Ornament, 1" Sergeant Chevrons, Gold
3		<b><i>Silking Brothers, Int'l. **Or Approved Equal**</i></b>
4	X201905A	Sergeant Chevron's, 3 1/2" Metallic Gold on Dark Navy Background
5	08LE	Name Tag, 2 1/2" x 5/8", Glossy Gold w/Cobalt Blue Lettering, Clutch Back
6	X157134G	Custom Department Emblems, Full Size
	X157134B	Custom Department Emblems, Subdued Size
7	KCJHashmark#2	Custom Hashmarks
8	GOLD	

9 **MISCELLANEOUS**

10		Concealment Holster, Level 2 or Higher, for Glock Model 17
	45015	Clip-On Tie, Samuel Broome, Dark Navy
11	A367	Tie Clasp, Blackington, Gold Plate w/Department Emblem
	66318	Personal Flashlight, MicroStream LED
12	SF123A	No Strike
	560	Key Holder, Leather Black Basket-Weave w/Brass Snap
13	564	Silent Key Holder, Leather Black Basket-Weave w/Brass Snap
14	S251	"Fisher" Space Pen
	SPR2 / SPR4	Space Pen Re-Fills, Red & Black
15	372451	Glove Pouch w/CPR Mask

**ADDENDUM A – WAGES****Corrections Officer**

Job Class Code: 5214100

PeopleSoft Job Code: 001404

Hourly Wage Rates Effective:

	<b>01/01/2020</b>	<b>01/01/2021</b>
<b>Start</b>	\$30.8933	\$30.8933
<b>12 Months</b>	\$33.3287	\$33.3287
<b>24 Months</b>	\$34.8867	\$34.8867
<b>36 Months</b>	\$36.4947	\$36.4947
<b>48 Months</b>	\$38.0343	\$38.0343
<b>60 Months</b>	\$40.0191	\$40.0191
<b>72 Months</b>	\$41.2198	\$41.2198

**Corrections Supervisors (Sergeant)**

Job Class Code: 0001407

PeopleSoft Job Code: 0001407

Hourly Wage Rates Effective:

	<b>01/01/2020</b>	<b>01/01/2021</b>
<b>Start</b>	\$43.2801	\$43.2801
<b>12 Months</b>	\$44.3983	\$44.3983
<b>24 Months</b>	\$46.0064	\$46.0064
<b>36 Months</b>	\$47.3921	\$47.3921
<b>48 Months</b>	\$48.8139	\$48.8139
<b>60 Months</b>	\$50.2783	\$50.2783

- A. All step increases are based upon satisfactory performance during previous service.
- B. Satisfactory performance shall mean an overall rating of "Meets Standards" or "Exceeds Standards" on the Employee Work Performance Review Report.
- C. If the performance of the employee is rated "Unsatisfactory" or "Improvement Needed" on any factor or overall rating, specific facts on which the rating is based must be provided; such facts shall include time, place, and frequency of unacceptable performance.
- D. The employee, if denied a step increase, shall be placed on either monthly or quarterly evaluations and at such time that the employee's performance becomes "Satisfactory" as defined supra, the employee shall receive the previously denied step increase the first of the

1 month following attainment of a "Satisfactory" evaluation. The date on which an employee  
2 would be entitled to a future step increase will not be affected by the above action.

3 **Longevity Incentive Pay:** Additional compensation added to base bi-weekly salaries of  
4 Corrections Officers and Corrections Supervisors. Calculation of same to be on a percentage  
5 basis using the employee's current pay step as the base. Amounts as follows:

6 After 6 years of service:	1%
7 After 8 years of service:	2%
8 After 10 years of service:	3%
9 After 12 years of service:	4%
10 After 15 years of service	5.25%

11 **Education Incentive Pay:** Corrections Officers and Corrections Supervisors (Sergeants) hired  
12 prior to 1/1/91.

13 Associate	Bachelors	Major Subject
14 \$31 per month	\$62 per month	15 Psychology 16 Sociology 17 Criminology 18 Police Science 19 Admin. Of Justice 20 Related Field of Study

21 Longevity and/or Education Incentive Pays shall be paid beginning the first of the month  
22 following the month in which the employee first qualifies for the incentive(s). Employees will  
23 not be allowed to receive educational incentive pay and tuition reimbursement as referenced in  
24 Article 17. Participation in the Tuition Reimbursement Program cancels all rights to education  
25 incentive pay.  
26  
27  
28



**MEMORANDUM OF AGREEMENT**  
**Regarding Insured Benefits**  
**January 1, 2019 through December 31, 2020**  
**For Represented Benefits-Eligible Employees**  
**By and Between**  
**King County**  
**And**

**Joint Labor Management Insurance Committee of Unions**

**Subject: Joint Labor Management Insurance Committee Benefits Agreement**

**WHEREAS**, certain designated representatives of King County (“County”) and the Joint Labor Management Insurance Committee of Unions (“Unions”) signatory to this Memorandum of Agreement (“Agreement”), referred to hereafter as the “Parties,” have agreed to participate in negotiations as members of the Joint Labor Management Insurance Committee (“JLMIC”) for the purpose of negotiating the plan provisions and funding of the County’s fully insured and self-insured medical, dental, vision, disability, accidental death and dismemberment, and life insurance programs (“insured benefits”); and

**WHEREAS**, the County and the Unions have agreed to a format for negotiating plan provisions and funding to meet the anticipated cost increases associated with providing insured benefits to represented, benefits-eligible employees; and

**WHEREAS**, the JLMIC agrees that for the term of this Agreement, insured benefits will include a wellness program, a Health Maintenance Organization Plan (“HMO”), a Preferred Provider Organization Plan (“PPO”) and an Accountable Health Network Plan (“AHN”); and

**WHEREAS**, the JLMIC agrees to explore options that incent benefits-eligible employees to choose healthcare that is more effective and produces better health outcomes;

**NOW THEREFORE**, having bargained in good faith, the JLMIC hereby agrees to the following:

- 1. Scope of Agreement.** This Agreement shall be offered by the County to all employees represented by the unions signatory to the 2017-2018 JLMIC Health Benefits Memorandum of Agreement. In addition, this Agreement shall apply to any non-represented employees identified by the County to be treated in the same way as the represented employees covered by this Agreement. This Agreement shall not be offered to any employees represented by the Amalgamated Transit Union, Local 587, the King County Police Officers’ Guild, the Puget Sound Police Managers Association, and the Technical Employees’ Association representing employees in Transit. All employees to which this Agreement applies shall be referred to as “JLMIC-Eligible Employees.”
- 2. Continuation and Administration of JLMIC Protected Fund Reserve.** The balance of the 2018 JLMIC Protected Fund Reserve (“PFR”) shall be carried over to this Agreement and the PFR shall continue to be maintained solely for the purpose of funding, providing and maintaining insured benefits, and providing a reserve fund to self-insure against unanticipated increases in the cost of those insured benefits, for JLMIC-Eligible Employees. It is expressly agreed that no funds from the PFR shall at any time be used for any other purpose except for benefits outlined in this Agreement. It is further agreed that the County and organizations handling PFR funds have a responsibility to ensure that PFR funds are being used solely on behalf of JLMIC-Eligible Employees.

**3. County Funding Rate.**

- A. Commencing on January 1, 2019, the County shall maintain the same funding rate contributed in 2018 (i.e., \$1,524 per month) on behalf of each JLMIC-Eligible Employee.
- B. Commencing on January 1, 2020, the County shall maintain the same funding rate contributed in 2018 (i.e., \$1,524 per month) on behalf of each JLMIC-Eligible Employee.

**4. Insufficient County Funding.** To the extent that the County's funding rate identified in Paragraph 3 and other yearly non-funding rate revenue (e.g., interest earnings, participant benefit access fees, and other plan participant contributions such as COBRA payments), attributed proportionally to JLMIC-Eligible Employees, is at any time inadequate to fully fund the cost of providing insured benefits for JLMIC-Eligible Employees, the Parties agree that the PFR will be used to fund the difference until such time as the PFR is exhausted.

**5. Excess County Funding.** To the extent that the County's funding identified in Paragraph 3, and other yearly non-funding rate revenue, attributed proportionally to JLMIC-Eligible Employees, provides greater funding than is necessary to fully fund the cost of insured benefits for JLMIC-Eligible Employees, the Parties agree that the excess shall be added to the PFR.

**6. Modification to Health and Welfare Plan Provisions.** The JLMIC is hereby empowered to negotiate and implement modifications to insured benefits for JLMIC-Eligible Employees during the term of this Agreement. The JLMIC will negotiate any changes to plan provisions and/or supplemental premium funding methodology to be effective on January 1 of the following calendar year.

**7. Health and Welfare Plan Provisions.** Insured benefits provisions for JLMIC-Eligible Employees during the term of this Agreement shall be as described in Attachment A, including but not limited to maintaining the 2019-2020 JLMIC-Eligible Employees' out-of-pocket costs for the HMO, PPO and ACN plans, unless otherwise modified by the Parties or modified pursuant to the terms of this Agreement. The Parties hereby agree that modifications will be by written agreement subject to ratification, as necessary.

**8. Health Reimbursement Arrangement (HRA) Voluntary Employees Beneficiary Association (VEBA).** The County will continue to offer HRA VEBA benefits to JLMIC-Eligible Employees as described in Attachment B.

**9. Supplemental Medical Plan(s).** During the term of this Agreement, the Parties may add a supplemental plan(s) option(s) beyond the HMO, PPO and ACN plans for the 2019-2020 benefits years.

**10. Scope and Purpose of the Annual Reconciliation Meeting.** The JLMIC will convene a reconciliation meeting no later than April 15th of each calendar year to review the insured benefits expenditures for the prior year, projected expenditures for the current and future year(s), plan provisions, and any other information or factors that the JLMIC deems relevant.

**11. Dispute Resolution.** If at any time during the term of this Agreement, the PFR is projected to fall below fifteen million dollars (\$15,000,000), the JLMIC must consider plan changes

and may consider other funding options to be implemented by the following January 1. If the JLMIC is unable to reach agreement on such modifications by June 1st of any calendar year, the matter will be submitted to a panel of three (3) subject matter experts ("Panel") for final and binding resolution, whose decision must be issued no later than August 15 of the same calendar year. The Panel shall be comprised of one expert selected by the County, one (1) expert selected by the Unions, and one (1) expert selected jointly by the two (2) selected partisan experts. The Parties agree to cooperate to present relevant information to the Panel in sufficient time for the Panel to issue a decision by August 15th. The Panel shall be empowered to make plan design changes and/or add employee premium share and/or County contribution increases. The costs of the Panel shall be paid out of the PFR.

- 12. **Subsequent Agreement.** The Parties agree to commence negotiations for a successor insured benefits agreement (to be effective starting January 1, 2021) no later than January of 2020.
- 13. **Total Agreement.** This Agreement constitutes the entire agreement with respect to the matters covered herein, and no other agreement, statement or promise made by any party which is not included herein shall be binding or valid. This Agreement may be modified or amended only by a written agreement.
- 14. **Term.** This Agreement shall be in effect following adoption of an ordinance by the King County Council, from January 1, 2019 through December 31, 2020.

For the Joint Labor Management Insurance Committee of Unions:

  
 \_\_\_\_\_  
 Dustin Frederick, Business Manager  
 Public Safety Employees Union  
 Co-Chair, Joint Labor Management Insurance Committee

10/18/18  
Date

For the Joint Labor Management Insurance Committee of Unions:

  
 \_\_\_\_\_  
 Denise Cobden, Union Representative  
 Professional and Technical Employees, Local 17  
 Co-Chair, Joint Labor Management Insurance Committee

10/18/18  
Date

For King County:

  
 \_\_\_\_\_  
 Megan Pedersen, Director  
 Office of Labor Relations, King County Executive Office  
 Co-Chair, Joint Labor Management Insurance Committee

10.18.18  
Date

For King County:

  
 \_\_\_\_\_  
 Robert Railton, Labor Relations Manager  
 Office of Labor Relations, King County Executive Office  
 Co-Chair, Joint Labor Management Insurance Committee

10/18/18  
Date

## ATTACHMENT A

### JLMIC Plan Design for 2019-2020

	Kaiser Permanente*	KingCare <sup>SM</sup> Select		KingCare <sup>SM</sup> PPO*	
		In-Network	Out-of-Network	In-Network	Out-of-Network
<b>Deductible (Single/family)</b>	\$0	\$200/\$600**	\$500/\$1,500	\$300/\$900	
<b>Out-of-pocket maximum (Deductible + copay) Single/Family</b>	\$1,000/\$2,000	\$1,100/\$2,400	\$2,500/\$5,500	\$1,100/\$2,500	\$1,900/\$4,100
<b>Office Visit Copay/Coinsurance</b>	\$20 copay	\$20 (no deductible)	40%	15%	35%
<b>In-patient Hospital Copay/Coinsurance</b>	\$200 copay	10%	40%	15%	35%
<b>Emergency Room</b>	\$100 copay (\$100 for out-of-network)	\$200 copay, 10% coinsurance		\$200 copay, 15% coinsurance	
<b>Retail Prescription Drug (Mail 2x Copay)</b>	Copays apply to out-of-pocket maximum	Out of pocket limit on Rx drugs: \$1,500/\$3,000		Out of pocket limit on Rx drugs: \$1,500/\$3,000	
<b>Generic</b>	\$10 copay	\$5 copay		\$7 copay	
<b>Brand Formulary</b>	\$20 copay	\$25 copay		\$30 copay	
<b>Non-Formulary</b>	\$30 copay	\$75 copay		\$60 copay	
<b>2019 Deductible Waiver</b>	\$0	\$200 lower deductible		\$0	
<b>Benefit Access Fee</b>	\$0	\$0		\$100***	

\* There is only Gold level plans in 2019. The Bronze and Silver level plans have been eliminated.

\*\* The AHN in-network deductible for 2019 is \$0/\$400.

\*\*\* The Benefit Access Fees are paid on a pre-tax basis.

**ATTACHMENT B**  
**MEMORANDUM OF AGREEMENT**  
**Regarding HRA VEBA**  
**January 1, 2019 through December 31, 2020**  
**For Represented Benefits-Eligible Employees**  
**By and Between**  
**King County**  
**And**  
**Joint Labor Management Insurance Committee of Unions**

**Whereas**, the parties have negotiated employees' participation in the Health Reimbursement Arrangement (HRA) Voluntary Employees Beneficiary Association (VEBA) Medical Reimbursement Plan for Public Employees in the Northwest since 2007; and

**Whereas**, the parties seek to clarify, update and make consistent the HRA VEBA options and elections process available to King County employees; and

**Whereas**, the parties have negotiated in good faith; now

**Therefore**, the parties hereby agree to the following HRA VEBA-related provisions:

1. The County adopted the HRA VEBA Plan in 2007. The HRA VEBA Plan is a tax-exempt trust authorized by Internal Revenue Code Section 501(c)(9). Under the IRS code requirements, if a VEBA bargaining unit opts to participate in the HRA VEBA Plan, all eligible employees in positions covered by the bargaining unit must participate. The specific VEBA funding options put in place via the agreed upon King County VEBA elections process will remain in effect for that bargaining unit, unless specific action is taken through this same process to amend or terminate it. Prior to having access to HRA VEBA contributions, the employee must complete and submit an HRA VEBA enrollment packet to Benefits, Payroll and Retirement Operations (BPROS).

The following options are currently available to participating bargaining units:

**a. Sick Leave Cash Out at Retirement VEBA Option:** If a retiring employee is in a VEBA bargaining unit that has opted to participate in the HRA VEBA Plan and has elected this option, the County will transfer funds equal to that participating employee's cash out of eligible, compensable sick leave tax-free to a VEBA trust account on that employee's behalf at his/her retirement. These funds will be transferred to the HRA VEBA account in lieu of the regular cash out to the employee, not in addition to the regular cash out. The funds will be available to the member to pay for eligible health care-related expenses after retirement. De minimis amounts under \$200 will not be subject to the HRA VEBA provisions and will be paid out directly to the employee and subject to appropriate supplemental taxes.

**b. Vacation Cash Out at Retirement Option:** If a retiring employee is in a bargaining unit that has opted to participate in HRA VEBA and has elected this option, the County will transfer funds equal to fifty (50) percent of that participating employee's cash out of eligible vacation leave tax-free to an HRA VEBA trust account on that employee's behalf at his/her retirement. These funds will be transferred to the HRA VEBA account in lieu of the regular cash out to the employee, not in addition to the regular cash out. The funds in the HRA VEBA Plan will be available to the member to pay for eligible health care-related expenses after retirement. De minimis amounts under \$200 will not be subject to the HRA VEBA provisions and will be paid out directly to the employee and subject to appropriate supplemental taxes.

The parties understand that the VEBA options and elections process must comply with applicable law, and options available or conditions placed on specific options may change from time to time as necessary to comply with legal and systems requirements. Should the County need to change options or process due to legal requirements or systems changes, it will so notify unions and discuss such changes in the Joint Labor Management Insurance Committee (JLMIC).

Unions opting to conduct a VEBA election must report election results for each bargaining unit to King County BPROS using the King County standardized form found on the BPROS Website. If there are discrepancies in the parties' understandings of the makeup of the individual bargaining units, the parties will meet to discuss and resolve the issue.

Unions may conduct VEBA elections once per year, if they so choose. Election results must be received by King County BPROS by the last Friday in June each year, for implementation the following year. Bargaining Units that are participating in the HRA VEBA Plan and wish to terminate, or who wish to change their options, may do so via the above referenced election process and agreed upon reporting process. Union representatives must notify the King County BPROS no later than the last Friday in June of 2019 and 2020, using the County's standardized VEBA elections report form, of the VEBA Program Option election results for each County identified bargaining unit.

Bargaining units that are not currently participating in the HRA VEBA Plan may elect to participate in the HRA VEBA Plan effective January 1, 2020, by following the VEBA election and reporting process outlined in this Memorandum of Agreement.

**2. Irrevocability.** Contributions to HRA VEBA are irrevocable and will be available to provide payment for health care-related expenses incurred by the participating employee, his/her spouse, and eligible dependents until exhausted, as provided for by the terms of the HRA VEBA Plan and regardless of any subsequent changes to future contributions elected by the bargaining unit.

**3.** The parties agree that a standardized VEBA elections process is in their best interests and that they consequently may meet from time to time in JLMIC to discuss changes that may contribute to the efficiency of this process.

**4. Total Agreement.** This Agreement is the complete and final agreement on the subject of VEBA elections (in addition to any applicable collective bargaining agreement provisions) between the parties, and may be modified or amended only by a written amendment executed by all parties hereto.

**5. Severability.** The provisions of this Agreement are intended to be severable. If any term or provision of this Agreement is deemed illegal or invalid for any reason, such illegality or invalidity shall not affect the validity of the remainder of this Agreement.

**6. Term.** This Agreement shall be effective January 1, 2019, through December 31, 2020, consistent with the duration of the JLMIC Benefits Agreement, and any successor to this Memorandum of Agreement is intended to track with future JLMIC Benefits Agreements.

**MEMORANDUM OF AGREEMENT**  
**Regarding Insured Benefits**  
**January 1, 2019 through December 31, 2020**  
**For Represented Benefits-Eligible Employees**  
**By and Between**  
**King County**  
**And**  
**Joint Labor Management Insurance Committee of Unions**

**Subject: SmartCare Plan - ACA "Grandfather Status"**

**WHEREAS**, the Joint Labor Management Insurance Committee (JLMIC) is empowered to negotiate and implement modifications to insured benefits for JLMIC-Eligible Employees to be effective on January 1 of the following calendar year;

**NOW THEREFORE**, having bargained in good faith, the JLMIC hereby agrees to the following:

1. Due to changes to the SmartCare plan (HMO), it lost "grandfather status" under the Affordable Care Act (ACA). Therefore, the JLMIC agrees to make the following changes to comport with law:

- a. The emergency room and prescription copays will apply to the annual out-of-pocket maximum.
- b. The emergency room copay for out-of-network coverage will be at the same rate of the in-network emergency room copay.

2. **Term:** This Agreement shall be in effect January 1, 2019 following adoption of an ordinance by the King County Council.

For the Joint Labor Management Insurance Committee of Unions:

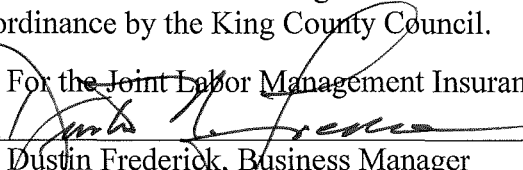
  
\_\_\_\_\_  
Dustin Frederick, Business Manager  
Public Safety Employees Union  
Co-Chair, Joint Labor Management Insurance Committee

10/18/18  
Date

For the Joint Labor Management Insurance Committee of Unions:

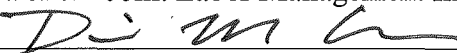
  
\_\_\_\_\_  
Denise Cobden, Union Representative  
Professional and Technical Employees, Local 17  
Co-Chair, Joint Labor Management Insurance Committee

10/18/18  
Date

For King County:

  
\_\_\_\_\_  
Megan Pedersen, Director  
Office of Labor Relations, King County Executive Office  
Co-Chair, Joint Labor Management Insurance Committee

10.18.18  
Date

For King County:

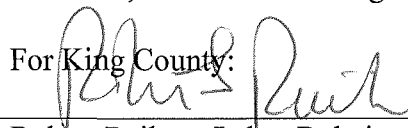
  
\_\_\_\_\_  
Robert Railton, Labor Relations Manager  
Office of Labor Relations, King County Executive Office  
Co-Chair, Joint Labor Management Insurance Committee

10/18/18  
Date



**MEMORANDUM OF AGREEMENT**  
**Regarding Insured Benefits**  
**January 1, 2019 through December 31, 2020**  
**For Represented Benefits-Eligible Employees**  
**By and Between**  
**King County**  
**And**  
**Joint Labor Management Insurance Committee of Unions**

**Subject: Early Retiree Subsidy**

**WHEREAS**, the Joint Labor Management Insurance Committee (JLMIC) is empowered to negotiate and implement modifications to insured benefits for JLMIC-Eligible Employees to be effective on January 1 of the following calendar year;

**NOW THEREFORE**, having bargained in good faith, the JLMIC hereby agrees to the following:

1. JLMIC-Eligible Employees who retire from County service and elect a JLMIC benefits plan upon retirement shall be eligible for a medical premium subsidy, as provided under Section 2 below, provided they meet the following terms and conditions:

- a. The JLMIC-Eligible Employee retires as defined by the County.
- b. The JLMIC-Eligible Employee retires in 2019 or 2020; or,
- c. The JLMIC-Eligible Employee retired between January 1, 2016 and December 31, 2018, and elects a JLMIC plan during open enrollment for the 2019 benefit year (there is no retroactive application of the subsidy prior to 2019).
- d. The JLMIC-Eligible Employee is not eligible for Medicare.

2. The medical premium subsidy shall be the COBRA rate for each offered medical plan (e.g., PPO, HMO) and plan tier (e.g., retiree only, retiree and spouse, retiree and child(ren), retiree and full family).

3. **Term:** This Agreement shall be in effect January 1, 2019 following adoption of an ordinance by the King County Council.

For the Joint Labor Management Insurance Committee of Unions:

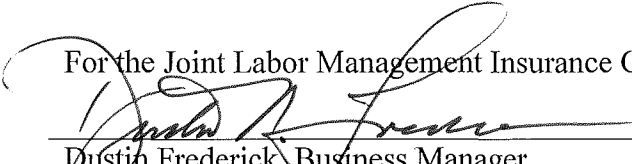

Dustin Frederick, Business Manager  
Public Safety Employees Union  
Co-Chair, Joint Labor Management Insurance Committee

10/18/18  
Date

For the Joint Labor Management Insurance Committee of Unions:



Denise Cobden, Union Representative  
Professional and Technical Employees, Local 17  
Co-Chair, Joint Labor Management Insurance Committee

10/18/18  
Date

For King County:



Megan Petersen, Director  
Office of Labor Relations, King County Executive Office  
Co-Chair, Joint Labor Management Insurance Committee

10.18.18  
Date

For King County:



Robert Railton, Labor Relations Manager  
Office of Labor Relations, King County Executive Office  
Co-Chair, Joint Labor Management Insurance Committee

10/18/18  
Date

**MEMORANDUM OF AGREEMENT**  
**Regarding Insured Benefits**  
**January 1, 2019 through December 31, 2020**  
**For Represented Benefits-Eligible Employees**  
**By and Between**  
**King County**  
**And**

**Joint Labor Management Insurance Committee of Unions**

**Subject: Long Term and Short Term Disability Plans**

**WHEREAS**, the Joint Labor Management Insurance Committee (JLMIC) is empowered to negotiate and implement modifications to insured benefits for JLMIC-Eligible Employees to be effective on January 1 of the following calendar year;

**NOW THEREFORE**, having bargained in good faith, the JLMIC hereby agrees to the following:

**Long Term Disability - Summary:**

1. The current Long Term Disability Plan (LTD) buy-up plan (i.e., 90 days elimination period) JLMIC-Eligible Employees can elect to self-pay will be eliminated.
2. The JLMIC will fund 100% of the cost of Long Term Disability Plan (LTD) that has an elimination period of 90 days for JLMIC-Eligible Employees. This improves the current LTD plan which had a 180 days elimination period.
3. The benefit amount will be 60% of the employee's salary up to \$7,200 maximum monthly amount. This improves the salary replacement amount which was \$6,000 maximum monthly amount.

**Short Term Disability - Summary:**

1. The JLMIC shall offer a Short Term Disability Plan (STD) option for JLMIC-Eligible Employees who will be responsible for paying 100% of the premium cost.

2. If a JLMIC-Eligible Employee elects the STD, the plan will provide a benefit amount of 60% of salary up to \$1,500 maximum weekly benefit (\$130,000 annual salary) for a 90 day benefit period.

3. **Term:** This Agreement shall be in effect January 1, 2019 following adoption of an ordinance by the King County Council.

For the Joint Labor Management Insurance Committee of Unions:

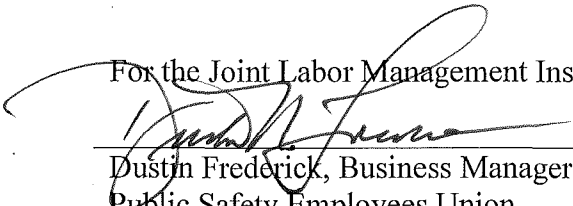

Dustin Frederick, Business Manager  
Public Safety Employees Union  
Co-Chair, Joint Labor Management Insurance Committee

10/18/18  
Date

For the Joint Labor Management Insurance Committee of Unions:



Denise Cobden, Union Representative  
Professional and Technical Employees, Local 17  
Co-Chair, Joint Labor Management Insurance Committee

10/18/18  
Date

For King County:

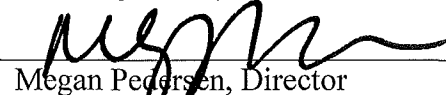

Megan Pedersen, Director  
Office of Labor Relations, King County Executive Office  
Co-Chair, Joint Labor Management Insurance Committee

10.18.18  
Date

For King County:



Robert Railton, Labor Relations Manager  
Office of Labor Relations, King County Executive Office  
Co-Chair, Joint Labor Management Insurance Committee

10/18/18  
Date

**MEMORANDUM OF AGREEMENT  
Regarding Insured Benefits  
January 1, 2019 through December 31, 2020  
For Represented Benefits-Eligible Employees  
By and Between  
King County  
And**

**Joint Labor Management Insurance Committee of Unions**

**Subject: Vision Plan Enhancement**

**WHEREAS**, the Joint Labor Management Insurance Committee (JLMIC) is empowered to negotiate and implement modifications to insured benefits for JLMIC-Eligible Employees to be effective on January 1 of the following calendar year;

**NOW THEREFORE**, having bargained in good faith, the JLMIC hereby agrees to the following:

1. The hardware (i.e., frames, contacts) allowance under the vision plan will be increased to \$200 every 24 months from \$130 every 24 months.

2. **Term:** This Agreement shall be in effect January 1, 2019 following adoption of an ordinance by the King County Council.

For the Joint Labor Management Insurance Committee of Unions:

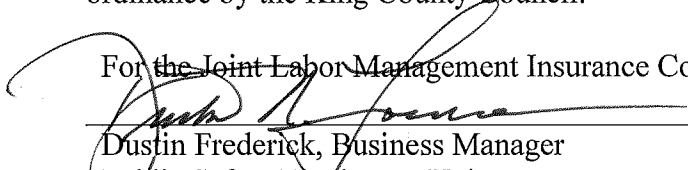
  
\_\_\_\_\_  
Dustin Frederick, Business Manager  
Public Safety Employees Union  
Co-Chair, Joint Labor Management Insurance Committee

10/18/18  
Date

For the Joint Labor Management Insurance Committee of Unions:

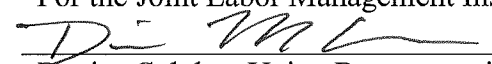
  
\_\_\_\_\_  
Denise Cobden, Union Representative  
Professional and Technical Employees, Local 17  
Co-Chair, Joint Labor Management Insurance Committee

10/18/18  
Date

For King County:

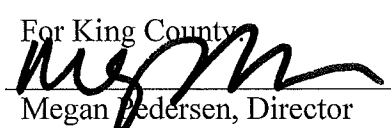
  
\_\_\_\_\_  
Megan Pedersen, Director  
Office of Labor Relations, King County Executive Office  
Co-Chair, Joint Labor Management Insurance Committee

10.18.18  
Date

For King County:

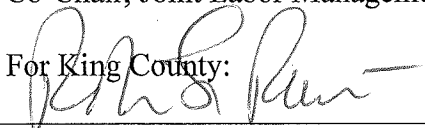
  
\_\_\_\_\_  
Robert Railton, Labor Relations Manager  
Office of Labor Relations, King County Executive Office  
Co-Chair, Joint Labor Management Insurance Committee

10/18/18  
Date

## Attachment -1

### TRANSFER REQUEST PROCEDURES

#### PURPOSE

Transfer request procedures were established for the purpose of providing fair and consistent guidelines for the process of employee's requests for transfer to different furlough and/or facility/shift.

#### SCOPE

The procedures apply to requests for transfers arising from:

1. An employee's desire to change facility/shift and/or furloughs or;
2. Transfers required due to completion of term of a selected (special) assignment.
3. The procedures may not apply to probationary employees since they are subject to shift rotation and available furloughs during their probationary year.

#### STAFF RESPONSIBILITIES

**Corrections Officer:** Corrections officers desiring to transfer are to complete an officers report and submit the request to the Administrative Sergeant at their facility. If request is submitted for reasons of hardship, an officers report should be attached explaining situation necessitating the need for transfer.

**Administrative Sergeant:** Administrative Sergeant will add the Officer's request to the transfer request file. The file will then be processed to determine current transfer order. A transfer request roster will be posted and maintained showing furloughs and/or facility/shift requests pending.

**Facility Commander:** The Facility Commander shall consider requests submitted for reason(s) of hardship and approve or deny request based on merit and department needs.

#### PROCESSING METHODOLOGY

Processing Order:

1. Subsequent to Annual Rotation Assignment, officers who are transferred by the department due to changes in shift staffing levels or furlough distribution, shall have first consideration for assigned furloughs and/or facility/shift held prior to transfer.
2. Requests for change of furloughs shall be processed before requests for change of shift.
3. All requests will be processed on a first-come/first served basis as determined by request submittal date. If multiple requests are submitted on the same date, an employee's seniority will be used to determine processing order.
4. An employee will be given their highest preference (choice) available at time of processing

#### AVAILABLE OPENINGS

The department shall determine if a furlough or shift opening exists and when the opening is to be filled.

## Attachment -1

### OPEN TRANSFER REQUEST PERIOD

An open request period of thirty (30) days shall be established subsequent to posting of the Annual Assignment Roster (Dream Sheet Report). All requests received during this period will be given the same request submittal date. Processing order for these requests will be based on an Officer's seniority.

An announcement of this open transfer request period will be posted indicating the period's start and end date. All requests received following the close of this period will be given a request submittal date as verified by the Administrative Sergeant.

### PROCEDURAL OUTLINE

#### I. Request Submittal

- A. Open Transfer Request Period
  - 1. Period is thirty (30) days in length.
  - 2. All requests received are given same submittal date.
- B. Subsequent Requests (post open period)
  - 1. Submittal date is the date received and verified by the Administrative Sergeant.

#### II. Data Processing-Recording Request

- A. Request Limit- A limit of three requests will be maintained per employee, one request per shift.
- B. Requests received regarding a shift currently on file will cause the deletion of the old request. The submittal date for the shift will reflect the latest request date.
- C. Furloughs requested will be entered in order of preference (choice) shown on transfer request form (Officer's Report).
- D. Requests received shall be maintained on file in order of date received to provide a backup record system.

#### III. Transfer Processing Order

- A. All requests on file will be ordered as follows:
  - 1. Requests concerning a specific facility/shift, i.e., 1<sup>st</sup>, 2<sup>nd</sup>, and 3<sup>rd</sup>.
  - 2. Requests for change of furloughs only on specific shift.
    - a. Ordered by request submittal date.
    - b. Ordered by seniority if same submittal date.
  - 3. Requests for change to specific shift.
    - a. Ordered by request submittal date.
    - b. Ordered by seniority if same submittal date.
- B. All requests for change of furloughs from employees on shift will be processed before requests from employees requesting transfer to the shift.
- C. Requests from employees with multiple requests will be processed in the following order:
  - 1. A request for furlough change only.
  - 2. The earliest request date of change.
  - 3. If same request date, order listed on transfer request submittal.

## Attachment -1

### IV.. Furlough/Shift Assignment

- A. Based on available openings and decision to fill these openings, employees requesting furlough changes only will be assigned their highest preference available at the time of processing.
- B. Following furlough processing, officers will be assigned their highest preference of shift available at the time of processing.
- C. Following processing of shift changes, secondary reviews of requests for furlough and shift changes will be performed in order to fill opening created by shift transfer.

### V. Purging of Transfer Request File

- A. Automatic Purging: A request will be automatically purged provided:
  - 1. An employee has received or is currently on the shift for which the request refers, and;
  - 2. The employee has received the furloughs for which highest preference (choice) was noted.
- B. Purge at Employees Request: An employee may purge a request on file by submitting an officers report to the Administrative Sergeant.
- C. End of Calendar Year Purge: All requests on file will be purged following completion of the calendar year.

### VI. Transfer Request Roster

- A. A transfer request roster shall be posted and maintained showing current transfer requests on file. This roster shall be presented in Transfer Processing Order as discussed in Section III, A., above.