

Intended Terms for Lease with Option to Purchase for Waterfront Streetcar Maintenance Facility

This term sheet represents the intended terms of an agreement between King County and the Center of Pioneer Square LLC for the leasing by King County of a maintenance facility for the Waterfront Streetcar ("Maintenance Facility") to be constructed by Landlord. The Maintenance Facility will be constructed by Landlord as part of a mixed use building that will be located directly to the east of Occidental Park in the Pioneer Square neighborhood. The Maintenance Facility will include a shop and other facilities for streetcar maintenance and storage, suitable rail track, and an overhead catenary system. The mixed use building is expected to consist of four separate condominium units: the Maintenance Facility, a residential unit, a retail/commercial unit, and a parking unit. King County will lease the Maintenance Facility with an option to purchase when it is completed and ready for occupancy.

These intended terms will be more fully negotiated and agreed to in a lease agreement between King County and Landlord. The ultimate terms may vary from this term sheet to address changes to the project design, scope or financial structure agreed to by the parties. This term sheet is a statement of intent by the parties and will not become a binding commitment until the subsequent lease agreement is approved by the King County Council and executed by the parties.

Recitals:

1. King County currently operates a maintenance facility for the Waterfront Streetcar on City of Seattle right-of-way just to the north of Broad Street at the entrance to Myrtle Edwards Park.
2. The Seattle Art Museum's Olympic Sculpture Park is planned for the site occupied by the Maintenance Facility, requiring the removal of the facility.
3. After an extensive review of options, it has been determined that the site in Pioneer Square would provide an optimal location for the relocated maintenance facility.

Terms:

1. Parties/Basic Structure:
 - A. Landlord: Center for Pioneer Square LLC, a Washington limited liability company ("Landlord").
 - B. Tenant: King County, a municipal subdivision of the State of Washington.
 - C. Project: The Project includes the parcel of land located at 200 Occidental Avenue, which is on the east side of Occidental Park between Main Street and Washington Street, and the mixed use building and any other improvements that are to be constructed thereon, including a commercial condominium unit for the Maintenance Facility.
 - D. Premises: The construction by Landlord for leasing and acquisition by King County of the Maintenance Facility for the Waterfront Streetcar. The Maintenance Facility will include a shop and other facilities for streetcar maintenance and storage, suitable rail track, and an overhead catenary system.

E. Lease: King County will enter into a lease agreement with Landlord that will commence when the Premises are completed and suitable for occupancy as determined by King County ("Commencement Date"). The lease will be for a term of thirty (30) years, and will include an option to purchase the Premises as set forth below. Upon the exercise of the option King County will gain title to the Premises, subject to the condominium declaration and other Project documents.

F. Base Rent: During the term of the lease King County shall pay monthly base rental for the Premises as follows. Initially, monthly base rent shall be an amount equal to one-twelfth (1/12th) of the product of (a) the agreed value of the Premises as of the Commencement Date (*i.e.*, \$9,000,000), *multiplied by* (b) the Capitalization Rate. The "Capitalization Rate" shall be a rate equal to the greater of (y) four percent (4%), or (z) the rate earned by King County in the King County Investment Pool for the preceding month. If King County fails to timely exercise its option to purchase, then base rent for months 16 through 24 shall be \$112,500. Thereafter, base rent shall increase three percent (3%) annually.

G. Purchase Option: King County shall have the one-time right to purchase the Premises by giving Landlord written notice of its election to purchase the Premises on or before thirty (30) days after the first (1st) anniversary of the Commencement Date. The purchase price shall be \$9 million (minus any amount paid as a deposit), plus an amount equal to interest accrued on that amount, following deduction of any deposit, at the Capitalization rate since the Commencement Date. All sums paid as base rent up to the date of closing shall be credited toward the payment of the purchase price as of the date of payment. Closing shall occur between the sixtieth (60th) and ninetieth (90th) day after the first (1st) anniversary of the Commencement Date, or such other date as agreed to by the Parties.

H. Parking: Landlord shall provide King County with 8 parking stalls on a nonexclusive basis in the Project's parking facility or on an off-site location reasonably acceptable to King County.

I. Taxes and Operating Expenses: King County shall reimburse Landlord during the term of the lease for all taxes and assessments for the Premises, and for operating expenses representing a proportional share of the operating expenses for the Project.

J. Insurance: Landlord and King County shall each maintain appropriate insurance or self-insurance, as the case may be, for their respective liability associated with the Property.

K. Liens: The lease shall include commercial reasonable terms concerning liens on the Project and Premises.

L. Landlord Contingencies: Landlord's obligations shall be contingent upon the following "Landlord Contingencies" to be removed by a date certain that is as soon as reasonably practicable after execution of the agreement:

1. Feasibility. Landlord shall have satisfied itself in its sole discretion in regard to the feasibility of all attributes of the Project, including without limitation all legal, physical, and economic aspects of owning, developing, and operating the Project.

2. Plans. Landlord and King County shall have agreed upon plans and specifications for the Premises and the common elements of the Project that support the Premises.

3. Entitlements: Landlord shall have obtained all permits, licenses, and/or variances required for Landlord's development of the Project and construction of the Project upon terms and conditions acceptable to Landlord in its sole discretion. King County shall cooperate and assist Landlord in obtaining all necessary permits.

4. Financing: Landlord shall have obtained financing necessary and sufficient in Landlord's reasonable opinion to develop the Project upon terms and conditions acceptable to Landlord in its sole discretion.

M. King County Contingencies: King County's obligations shall be contingent upon the following "King County Contingencies" to be removed by a date certain that is as soon as reasonably practicable after execution of the agreement:

1. Feasibility. King County shall have satisfied itself in its sole discretion in regard to the feasibility of all attributes of the Premises, including without limitation all legal, physical, and economic aspects of owning, developing, and operating the Premises.

2. Plans. Landlord and King County shall have agreed upon plans and specifications for the Project and the common elements of the Project that support the Premises.

3. Entitlements: Landlord shall have obtained all permits, licenses, and/or variances required for Landlord's development of the Project and construction of the Project. King County shall cooperate and assist Landlord in obtaining all necessary permits.

4. Financing: King County shall have obtained appropriation or financing necessary and sufficient in King County's reasonable opinion to meet its obligations with regard to the Premises upon terms and conditions acceptable to King County in its sole discretion.

N. Exhibits: There are Exhibits attached to this term sheet. Where referenced in the text, such Exhibits shall be deemed to be incorporated into the Summary as if fully set forth therein.

2. Additional Terms and Conditions:

A. The maintenance facility will include the elements laid out and meet the design definition described in Exhibit A. The facility will contain sufficient space and facilities to meet the maintenance and storage needs of the existing five car historic trolley fleet. In addition, the facility will be designed to provide for the maintenance of the modern streetcar vehicles and to the extent possible for their storage as well, in the event that modern vehicles are added to the Metro fleet.

B. King County's ownership interest will be in the form of a condominium interest. The mixed use building is expected to consist of four separate condominium units: the Maintenance Facility, a residential unit, a retail/commercial unit, and a parking unit. The agreement to be entered into by Landlord and King County will include the terms and conditions associated with the condominium ownership.

C. Landlord shall furnish a bond satisfactory to King County conditioned on the delivery of possession of the completed Premises to King County at the time prescribed in the

lease, unavoidable delay excepted. The lease shall provide that no part of the cost of construction of the Project shall ever become an obligation of King County.

D. Maintenance of the Maintenance Facility within the interests to be leased and owned by King County will be the responsibility of King County. Maintenance of the remaining portions of the mixed-use building will be the responsibility of Landlord and/or a condominium association.

E. Landlord shall be responsible for obtaining all permits, licenses and approvals necessary to construct and occupy the Premises and shall pay all associated fees and costs.

F. Landlord shall be responsible for completion of design and for all services required for construction of the Premises. Landlord and King County shall agree to the conceptual plan for the Premises. Modifications and refinements to this plan may be made, provided the key elements and assumptions of the plan are carried forward into final design. King County shall review, inspect and approve the work related to the design (at 30%, 60%, and 100% design) of the Premises and the common elements of the Project that support the Premises. Prior to acceptance of a contractor's work by King County, Landlord and King County shall participate jointly in periodic and final inspections of the contractor's work.

G. Both parties commit to working together so that Landlord can commence construction of the Project and deliver the Premises to King County as soon as possible.

H. The lease shall include commercially reasonable subordination provisions.

200 OCCIDENTAL Feasibility Study

TABLE OF CONTENTS

- Project Summary**
- Preliminary Project Description (MITHUN)**
- Streetcar Maintenance Facility Design Definition (WATERLEAF ARCHITECTS)**
- Civil Narrative**
- Structural Design Narrative**
- Mechanical/Electrical/Plumbing Narrative**
- LEED Checklist**
- Concept Drawings**

Project Summary

Introduction

The intent of this study is to conceptually design a new building located in the heart of Pioneer Square on Occidental Park between Washington Street and Main Street. This project will bring together a unique mix of uses, including a multifamily high-rise and King County Metro's Street Car Maintenance Facility. This will be a privately owned project developed by Gregory Broderick Smith Real Estate with King County Metro's Street Car Facility as a condominium within.

Our design team has gathered specifications and developed drawings to a level of conceptual design in order to allow Sellen Construction to perform a pre-design pricing exercise. The goal is to give GBSRE and King County Metro a level of understanding that will allow them to reach a mutual agreement to then begin a full design process for this project's completion. This pivotal development for the Pioneer Square community will go through an extensive public design review process through the Pioneer Square Preservation Board. Since this process has not yet begun, the design developed to this point is only conceptual and brief in its content.

Building Owner:

Gregory Broderick Smith Real Estate

Condominium Owner:

King County Metro

Design Team:

Mithun	Project Architect
Waterleaf	Street Car Facility Architect
MKA	Structural & Civil
URS	Street Car Engineer
Flack & Kurtz	Mechanical / Electrical / Plumbing

Contractor:

Sellen Construction

Program

The program consists of a mixed-use building that includes four primary uses; Street Car Maintenance Facility, Retail, Condominium Units, Accessory Parking and Principal Use Parking. The square footage totals for each component vary depending on the scheme illustrated.

Site / zoning / construction type

The buildable property dimensions for this study are approximately 120' x 240'. There is a 2' alley right-of-way dedication given, reducing our footprint to 118' x 240'.

There is also a 9' buffer zone that is beyond our property line. For this study we are assuming we can build in this zone. Height limit for this zone is 100'. However due to the height requirements for the street car we are assuming a maximum structure height of 130', with the exception of a roof deck, amenity space and mechanical space. These structured areas will be limited to 25% of the roof area.

This is a high-rise building with Type 1 construction. We are proposing a concrete structure with concrete shear wall lateral resistance. Due to the soil conditions and high water table each scheme has specific solutions.

Design Strategies

Building Sectional options

We are looking at two design strategies for the development of parking solutions for our accessory and principal use parking. **Option A** ("All Up" scheme) places parking above grade beginning above our retail and continuing above the Street Car Facility. The condominium units simply sit on top of the parking, starting at an approximate 60' datum, up to the maximum height at 130'.

Option B ("All Down" scheme) places our parking below grade, providing for more housing units and allowing for more residential character onto Occidental Park. The "All Down" scheme would have to deal with a more complex shoring and de-watering solution.

Building Envelope & HVAC options

We are investigating two primary alternatives for the thermal conditioning of this project. **Option 1** is the Cooling option (see F & K narrative), which creates a more traditional mechanical cooling solution by using heat pumps and a ground loop heat exchanger (open loop) air conditioning system. This option would not incorporate exterior sun shading devices on the exterior, but will contribute to a LEED gold certification.

Option 2 uses a Heating only solution. There would be no mechanical cooling provided. Instead a more dynamic thermal envelope would be designed to control heat gain at the perimeter of the building to keep the heat out when not needed and allow it in when desired. Within this option operable sunshades would be incorporated on the west façade and controlled by building monitors with a manual override for each condo unit for individual control. On the south façade we would incorporate fixed horizontal sun shading devices to control summer heat gain. A night flush cooling system would also be used to take advantage of Seattle's cool evening temperatures and create cross ventilation through each unit.

Building Skin Assumptions

- 50 % vision glass (average 15 % operable)
- 30 % (3-brick blend) modular face brick ("Material B")
- 10 % metal panel ("Material C")
- 10 % stone veneer on precast panel ("Material A")
- For enclosure of Street Car Yard assume painted steel picket fence on perimeter and brick veneer at building edge

PRELIMINARY PROJECT DESCRIPTION – CONCEPT PHASE

ELEMENT A - SUBSTRUCTURE

A10 FOUNDATIONS

A1010 - Special Foundations:

- .01 All-Down Option: Secant piles; concrete pile caps.
 - a Temporary Shoring:
- .02 All-Up Option: Driven steel piles with concrete fill; concrete pile caps.

A1020 - Structural Slabs on Grade:

- .01 Self-supporting slabs spanning between grade beams.

A1030 - Pits and Bases:

- .01 Elevator Pits.

A20 - BASEMENT CONSTRUCTION

A2010 - Excavation

- .01 Refer to Geotechnical Report entitled for information regarding existing soil conditions and structural fill recommendations.

A2020 - Below Grade Walls:

- .01 Wall Construction: 10-inch thick cast-in-place concrete or shotcrete reinforced vertically and horizontally.
- .02 Vertical Blind Side Waterproofing: Bentonite blanket with integral HDPE liner; CETCO; Voltex DS.

A2020 - Below Grade Floors:

- .01 Floor Construction: 10-inch thick cast-in-place concrete reinforced with #4 steel bars.
- .02 Waterproofing: Bentonite blanket with integral HDPE liner; CETCO; Voltex DS..

ELEMENT B - SHELL

B10 SUPERSTRUCTURE

B1010 Floor Construction:

- .01 Post-tensioned concrete slabs supported by cast-in-place concrete columns.

B1020 Roof Construction

- .01 Post-tensioned concrete slabs supported by cast-in-place concrete columns.

B20 EXTERIOR CLOSURE

B2010 Exterior Walls

- .01 Exterior Skin:
 - a Masonry Veneer (Material A):
 - 1) Modular face brick installed in running bond with tooled concave joints.
 - i) Blend: Three-brick blend.
 - 2) Stainless steel seismic masonry anchors engaging continuous 9-gage stainless steel horizontal reinforcement wire.

200 OCCIDENTAL
SEATTLE, WASHINGTON

PRELIMINARY PROJECT DESCRIPTION – CONCEPT PHASE

- 3) Loose galvanized steel lintels over brick openings with 8-inch minimum bearing on each side of opening
 - 4) Stainless steel through-wall flashing at sills, lintels, and other cavity interruptions with self-adhesive bituminous membrane, Henry Blueskin SA. Fully solder all stainless steel flashing joints. Pre-fabricate all end dams, corner flashing, and similar embedded flashing elements.
 - 5) MortarNet cavity wall drainage material above all through-wall flashing.
 - 6) Weep holes in brick masonry at flashing locations on 24-inch centers.
 - 7) Trim units of cast stone, 5000 psi minimum, laid up with brick veneer.
 - b Concrete Masonry Units (Material B): 8x8x16, ground face, integral water repellent in masonry units and mortar, fully grouted.
 - c Stone Veneer (Material B): 1-1/4 inch slab stone veneer with stainless steel anchors, joints sealed with elastomeric sealant.
 - d Metal Wall Panels (Material C):
 - 1) 22 gage minimum, box rib profile, concealed fastener galvanized steel wall panels with 2-coat mica flake fluoropolymer finish.
 - e Curtainwall : Aluminum framed glazing system, fully pressure equalized, with operable window units and doors, minimum 10 psf water penetration resistance performance.
 - 1) Integral Sunshades: Provide integral fixed extruded aluminum sunshades.
 - 2) Thermal Performance: U-factor of not more than 0.41 Btu/sq. ft. x h x deg F when tested in accordance with NFRC for site built glazing systems.
 - f Storefront : Aluminum framed glazing system with entrance doors, minimum 6 psf water penetration resistance performance.
- .02 Wall Construction:
- a Metal Framing: Contractor designed per specified performance criteria.
 - 1) 6 inch cold-formed steel stud framing, G60 galvanized coating.
 - 2) Minimum 16 gage for masonry veneer back-up (l/720 deflection criteria), minimum 20 gage elsewhere.
 - b Wood Framing: 2x6 studs at 16 inches on center with plywood shear panels where indicated.
 - c Gypsum Sheathing: Georgia Pacific "Dens Glass Gold."
 - 1) Provide self-adhered bituminous membrane to seal all joints and penetrations.
- .03 Architectural Concrete:
- a Cast-in-place architectural concrete; MDO plywood formwork with reveals, sealed joints, custom placed ties holes.
- .04 Water Repellent: Silane/Siloxane mix, penetrating clear water repellent at all exterior exposed concrete, precast concrete, and masonry walls.
- .05 Vapor Retarders, Air Barriers and Thermal Insulation
- a Air Barrier: Provide exterior walls with an air tight barrier at interior gypsum wall board assembly by sealing all penetrations, terminations, head and sill tracks, etc.
 - b Vapor Diffusion Retarder: Certainteed "Mem-Brain."
 - c Thermal Protection:
 - 1) Exterior Stud Walls: Fiberglass batt insulation in stud cavity with extruded polystyrene outboard of gypsum sheathing; total R-value of stud wall assembly R-21 minimum.
 - 2) Underslab Insulation at Post-Tensioned Concrete Slabs: Semi-rigid or fiberglass batt insulation with spindle type stickpin fasteners and washers; white, perforated protective membrane; R-30 minimum.
- .06 Interior Skin:
- a 5/8 inch Type X gypsum wallboard.
- .07 Exterior Deck Railings:
- a Hot dip galvanized steel with hot dip galvanized steel bar pickets; field applied epoxy urethane coating.
- .08 Exterior Sun Control Devices:
- a Warema "60AF A6" with 52mm round profile guide rails.
 - 1) Standard cover panels type 09.

200 OCCIDENTAL
SEATTLE, WASHINGTON

PRELIMINARY PROJECT DESCRIPTION – CONCEPT PHASE

2) LONWORKS control system.”

B2030 Exterior Doors

- .01 Aluminum Entrances: Kawneer Medium Stile 350 aluminum framed, stile and rail glazed swinging doors, clear, insulating glazing. Finish to match storefront framing.
- .02 Balcony Doors: EFCO extruded aluminum Terrace Door, minimum 10-psf-water penetration resistance performance, fluoropolymer coating to match vinyl windows.
- .03 Hollow Metal Doors and Frames: U-Value 0.10 or better, 16 gage faces, 14 gage frames. Doors and frames to be galvanized, field painted.
 - a Hardware: Ball bearing butts, closers, locksets, thresholds, and weather-stripping.
- .04 Overhead Coiling Doors:
 - a Parking Garage: Un-insulated, perforated flat slat coiling doors, motor operated with loop detection for exiting vehicular traffic and card reading for entry.

B30 ROOFING

B3010 - Roof Coverings

- .01 Membrane Roofing: PVC alloy single ply membrane assembly, mechanically attached over rigid polyisocyanurate roofing insulation, heat welded seams.
- .02 Horizontal Waterproofing/Paver System: Fully reinforced hot fluid-applied rubberized asphalt waterproofing membrane, neoprene flashing, 24-inch square pavers on pedestals, landscaping. Provide complete systems by one of the following:
 - a American Hydrotech.
 - b American Permaquick.
- .03 Flashing and Sheet Metal: Galvanized steel sheet, factory-primed with epoxy primer, 24 gage minimum, field applied urethane finish in colors to match adjacent finishes. Provide self-adhesive butyl-based bituminous membrane under all copings; WR Grace Vycor Ultra.
 - a Provide 24 gage stainless steel flashing at scuppers and embedded flashing components

ELEMENT C - INTERIORS

C10 INTERIOR CONSTRUCTION

C1010 Interior Partitions:

- .01 Interior Fixed partitions:
 - a Retail/Garage: 5/8-inch Type X gypsum board on 22-gage metal studs typical.
 - b Residential: 5/8-inch Type X gypsum board on wood studs typical.
- .02 Shaftwall: Gypsum shaftwall system on metal framing at elevators and mechanical shafts.
- .03 Interior Doors:
 - a Typical rated and non-rated flush wood doors: 5-ply transparent finished Grade A birch veneer faces, solid core flush wood, AWI Premium grade; Western Oregon Door, Algoma Hardwoods, Eggers or Marshfield.
 - b Frames: Hollow metal, 16-gage typical.
- .04 Interior Service Doors:
 - a Typical rated and non-rated 18 gage hollow metal doors with 16 gage hollow metal frames; field painted.
- .05 Access Doors: Non-rated access doors and frames in drywall or masonry, 18 inches by 18 inches in size. Rated access doors and frames, 16 inches by 16 inches in size.

200 OCCIDENTAL
SEATTLE, WASHINGTON

PRELIMINARY PROJECT DESCRIPTION – CONCEPT PHASE

C1030 - Fittings:

- .01 Postal Specialties: USPS-Approved, front-loading, anodized aluminum apartment mailboxes and collection box.
- .02 Toilet Accessories:
 - a Public Areas: As manufactured by Bobrick, #4 stainless steel finish, Cameo series. One each per bathroom: Toilet tissue dispenser, paper towel dispenser, convenience shelf, soap dispenser, toilet seat cover dispenser.
 - b Residential: As manufactured by Franklin Brass, Satin Nickel finish, Astra Series. One each per bathroom: Towel bar, toilet paper holder.

C20 STAIRS

C2010 - Stair Construction:

- .01 Exit Stairs: Pre-engineered steel stairs with pan-filled concrete treads; closed risers.
- .02 Handrails: Steel pipe handrails, welded, shop primed and field painted.
- .03 Finishes: Sealed concrete treads and risers, painted GWB walls and ceilings.

C30 INTERIOR FINISHES

C3010 - Wall Finishes:

- .01 Gypsum Board:
 - a Gypsum Wallboard: ASTM C 36; maximum lengths available to minimize end-to-end butt joints in each area receiving finished gypsum board.
 - b Finish: ASTM C840 Level 4 smooth finish typical, Light "orange peel" finish at Residential Units; three-coats Low-VOC latex paint.
- .02 Tile Wall Finishes:
 - a Glazed 4-1/4" by 4-1/4" by 1/4", cushion edge. Latex thinset on backer board; latex grout.
 - b Backer Board: Georgia Pacific "Dens-Shield" fiberglass-faced gypsum units.
- .03 Interior Wall Paint: Water-based, Low VOC - no more than 50 grams per liter, typical. Benjamin Moore EcoSpec, Kelley Moore EnviroCote, Sherwin Williams Harmony, or approved.
- .04 Frameless Mirrors: 1/4 inch thick silvered mirror glass, beveled edges, clipped to wall top and bottom, adhesively attached to wall with Palmer MiroMastic.

C3020 - Floor Finishes:

- .01 Concrete Floor Finishes: Sealed at stairs, back of house areas, etc.; Ashford Formula zero VOC penetrating sealer.
- .02 Resilient Flooring:
 - a Residential Unit Utility Rooms: Solid vinyl, welded seams.
 - b Base: Rubber base, solid color. 4-inch height typical.
- .03 Carpet Flooring: Fiber type 6,6 nylon; solution dyed. Microbial resistant, stain resistant, and low static generation.
 - a Installation: Direct glue at public areas, stretched over pad at residential areas. Allowances as follows:
 - 1) Public Areas: \$25/square yard (carpet only).
 - 2) Residential Units: \$20/square yard (carpet only).
- .04 Ceramic Tile: 12 by 12 by 1/4 inch, unglazed, cushion edge, 7-1/2 percent slip resistant. Latex thinset; latex grout.
- .05 Stone Flooring: Mortar bed, dimensional stone flooring at lobby areas.

200 OCCIDENTAL
SEATTLE, WASHINGTON

PRELIMINARY PROJECT DESCRIPTION - CONCEPT PHASE

.06 Wood Flooring: Engineered 5 ply wood flooring, factory finished, floating installation.

C3030 - Ceiling Finishes:

.01 Gypsum Board Ceiling Finishes: Gypsum board on suspended metal support system. 3-coat latex paint finish.

ELEMENT D - SERVICES

D10 CONVEYING SYSTEMS

D1010 - Elevators and Lifts:

.01 Electric Traction Elevators:

- a Comply with the latest edition of the ASME A17.1 Safety Code for Elevators and Escalators, State of Washington Regulations, and ADA.
- b Elevators
 - 1) Type - Passenger.
 - 2) Capacity - 2500 pounds.
 - 3) Speed: 200 fpm.
 - 4) Stops: As indicated on drawings.
 - 5) Cab Finishes - \$10,000.00 allowance per cab.

.02 1090 - Hydraulic Elevators:

- a Comply with the latest edition of the ASME A17.1 Safety Code for Elevators and Escalators, State of Washington Regulations, and ADA.
- b Elevators
 - 1) Type - Passenger.
 - 2) Capacity - 2500 pounds.
 - 3) Speed: 150 fpm.
 - 4) Stops: As indicated on drawings.
 - 5) Location: Parking garage.

DOther Conveying Systems:

.01 Trash Chutes Wilkinson trash chute system with interlocking door mechanism; 1-1/2 hour door assemblies.

D20 PLUMBING

D2010 - Domestic Water Distribution:

D2020 - Rain, Water Drainage System:

D50 ELECTRICAL

D5010 - Site Lighting:

.01 Exterior light fixtures:

- a Wallwasher: Up lighting at concrete stiles in courtyard and building signage on wall at courtyard plaza at street level.
- b Landscape: Adjustable stake mount, low voltage, 50W MR16 Low Voltage transformer shall be accommodated in equipment or utility space out of view of courtyard.

200 OCCIDENTAL
SEATTLE, WASHINGTON

PRELIMINARY PROJECT DESCRIPTION – CONCEPT PHASE

ELEMENT E - EQUIPMENT AND FURNISHINGS

E10 EQUIPMENT

E1010 - Vehicular Equipment

- .01 Parking Control: Card reader entrance control system at garage entry points and at residential unit parking areas.
- .02 Loading Dock Equipment: Scissors lift and rubber bumpers.

E1020 - Other Equipment

- .01 Waste Compactors
 - a Minimum 2 cubic yard capacity, 5hp motor, 3-phase power.
 - b Provide 2 mobile containers per compactor.
- .02 Fire Extinguishers and Cabinets: Multi-purpose dry chemical type, heavy duty DOT steel tank; UL rating 2A-10B:C, 5 lb capacity.
 - a Provide manufacturer's standard box (tub), with trim, frame, door, and hardware to suit cabinet type, trim style, and door style indicated; fire rated where required.

E20 FIXED FURNISHINGS

E2010 - Casework

- .01 Manufactured Residential Casework: Transparent finished wood veneer exposed surfaces, melamine semi-exposed surfaces for cabinet boxes; transparent finish wood veneer flush drawer and door faces, white maple, plain sliced grade 'A' face veneer, AWI Custom grade minimum standard of quality for construction, AWI Premium grade System #4 Conversion Varnish or #6 Catalyzed Polyurethane transparent finish, custom pulls and knobs. Post-formed plastic laminate countertops.
- .02 Window Treatment: Levelor 1-inch wide mini-blinds.

E2020 - Code Required Signage

ELEMENT F - SPECIAL DEMOLITION AND CONSTRUCTION

- .01 Not Applicable

END OF DOCUMENT

waterfront streetcar extension &
maintenance facility relocation



Contract E43043E
Work Order #3
August 31, 2005

200 occidental
waterfront streetcar maintenance facility
design definition

prepared by:
Waterleaf Architecture & Interiors
URS Corporation
LTK Engineering Services

waterleaf

architecture, interiors and planning



621 S.W. Morrison
Suite 125
Portland, OR 97205
Ph: 503-228-7571
Fx: 503-273-8891
www.waterleafarch.com

Waterfront Streetcar Maintenance Facility Design Definition Report

Table of Contents

REPORT PURPOSE AND PROJECT OVERVIEW	2
DESIGN PROGRAM	2
SITE PROGRAM	2
<i>Streetcar Storage and Circulation</i>	2
<i>Site Access and Parking</i>	3
<i>Site Lighting and Signage</i>	3
<i>Construction in Main Street</i>	3
<i>Traction / Electrification</i>	3
<i>Overhead Contact System</i>	3
<i>Security</i>	4
<i>Fire Protection</i>	5
<i>Yard Storage</i>	5
<i>Refuse and Recycling Collection</i>	5
FACILITY LAYOUT	5
<i>Design Codes and Standards</i>	5
<i>Shop Layout and Functional Requirements</i>	5
DESIGN GUIDELINES	7
<i>Exterior Materials</i>	7
<i>Interior Materials</i>	7
<i>Building Signage</i>	7
<i>Structural</i>	8
<i>Trackwork</i>	8
<i>Lighting</i>	9
<i>Corrosion Control and Safety Grounding</i>	9
<i>Mechanical Systems</i>	10
<i>Electrical Systems</i>	10
<i>Fire Alarm</i>	10
<i>Communications</i>	11
<i>Security and Access Control</i>	11
<i>Intercommunications and Public Address</i>	11
<i>Cable TV</i>	12
EQUIPMENT	12
<i>Existing Equipment</i>	12
<i>New Equipment</i>	12
COST ESTIMATES	12

REPORT PURPOSE AND PROJECT OVERVIEW

The purpose of this report is to document the King County Waterfront Streetcar Maintenance Facility programming and conceptual design. The facility will be located at 200 Occidental Avenue in downtown Seattle between South Main Street and South Washington Street directly east of Occidental Park.

This report is based on the need to replace the existing Waterfront Streetcar Maintenance Facility to accommodate the storage and maintenance of King County's existing fleet of five 48-foot "Heritage" streetcars and future 67-foot "modern" streetcars.

The maintenance and repair philosophy for this facility includes daily and routine inspections, maintenance, on-car repairs, and interior/exterior cleaning of the streetcars consistent with the functions currently being performed at the existing Waterfront Streetcar Maintenance Facility. The facility will also serve as a component change-out location. Component rebuild and long term component repairs will be performed at another location.

DESIGN PROGRAM

The Waterfront Streetcar Maintenance Facility will be a stand alone facility that will be operated by King County and should function independently from other building areas and systems.

The design for the Waterfront Streetcar Maintenance Facility will be based on a facility accommodating the following program requirements:

- Streetcar Operations and Maintenance Administration
- Streetcar Storage
- Streetcar Dispatch
- Streetcar Operator Reporting
- Streetcar Service, Inspection and Component Change-out
- Streetcar Interior and Exterior Cleaning
- LRV Parts and Component Storage

SITE PROGRAM

Streetcar Storage and Circulation

Rail access to the site is via the existing mainline on Main Street at the south end of the site. The layout of the yard track-work was done using 82ft radius (No. 4) switches and no curves less than 66 ft. radius. Movements from shop bay to shop bay will require entering the mainline to switch and reverse operate. No run-around track or loop is provided.

Site Access and Parking

Access to the site will be provided from Occidental Street to the yard area at the south end of the building. A driveway access will be provided near the north end of the site to allow vehicular access to the shared parking area and for refuse/recycling containers. The employee entrance to the maintenance facility will be located at the south end of the building through the covered yard area.

Parking will be provided for employees as required by the Seattle Municipal Code. 18 parking spaces for staff and visitors have been provided in the parking garage. Access from the parking garage will be provided via elevator at the south end of the building to the ground floor sidewalk on Main Street and then to the Maint, Facility through a door and corridor to the east of the elevator.

Bicycle parking will be provided along with the maintenance facility changing / shower facilities to meet LEED requirements.

Access for deliveries will be provided through the covered yard area at the south end of the building. ___ dedicated parking spaces will be provided for delivery vehicles in accordance with the Seattle Municipal Code.

Site Lighting and Signage

The yard will be illuminated to provide a safe working environment for the ultimate 24-hour operation of the facility. Lighting will be controlled by a photoelectric cell. Lighting will be provided to a level of 1 foot-candle for the covered yard area. Appropriate signage will be provided at the main entry to the site and on the building.

Construction in Main Street

There will be a need to reconstruct part of Main street in order to add the necessary track and turnouts along the existing mainline. The limits of road reconstruction are presumed to be bounded by the existing tracks on the south, the existing curb on the north, the brick crosswalk (Occidental Park crosswalk) on the west and 10' east of the easternmost switch point being installed on the mainline. New tracks will cross Main street within these roadway limits to access the maintenance facility and the roadway will need to be regraded to match the elevation of the new tracks. The new tracks must match the elevation of the existing rails in Main street and will follow a virtually flat grade into the maintenance building. This will result in the elimination of the existing flow line on the north side of Main street (where the tracks cross the curb). The existing flow line will be regraded to channel roadway drainage to an existing inlet near Occidental Park and a new inlet near Waterfall Park. The flow line will also be raised to match the track elevations where the tracks cross the curb line. It is anticipated that roadway regrading will be accomplished by removing all existing asphalt pavement within the limits noted above, adding aggregate road base and installing 6" of new asphalt pavement to meet new elevations.

There is an existing sanitary sewer manhole located in Main street just south of the tracks where the alley intersects Main. It appears that this manhole will not be significantly impacted by new track construction, but there will likely be minor modifications needed. At this time it is assumed that the manhole cone will need to be rotated away from the existing tracks and that a new set of manhole steps will need to be installed inside the manhole.

Main Street will be closed to westbound traffic during track and roadway construction (estimated duration of closure = 6 weeks).

Traction / Electrification

A shop dc power supply including a rectifier / transformer / breaker will be provided for 600 Vdc traction power for the building. The electrical equipment will be housed in an enclosure located along the east wall of the covered yard area and will provide traction power for the streetcars within the shop building space. The electrical equipment will be grounded to the same grounding system as used for all of the other building ac electrical equipment for safety purposes.

Overhead Contact System

An overhead contact wire system will be required. The system will consist of an extension of the existing main line trolley wire system to section insulators just outside of the building. The yard will be powered by the mainline. A separate trolley wire system will be provided in the shop building with associated feeders and isolation switches to isolate six locations in the shop (consistent with the heritage trolley car positions). Conduits and distribution wiring for the OCS will be part of the building electrical construction. The OCS system will be arranged in a manner similar to the existing Waterfront Streetcar shop with cutouts above the shop doors to accommodate the wire passing through the building exterior wall with clearance for the trolley poles. The wire will be supported from the building structure and provided with insulators to isolate it from the structure.

A method will be provided, through the switching arrangement to positively ground the OCS for worker safety. The same arrangement of indicator lights as provided in the existing shop will be provided for indicating the power status of the overhead contact wire.

Security

Security will be provided by storing all streetcars inside the shop or covered yard area, by site lighting of the covered yard area and the perimeter of the building and by observation from the operations office on the mezzanine level into the alley to the east of the shop.

A 12 foot high picket-type iron gate similar to the adjacent Waterfall Park will be used to secure the covered yard area. A possible solution being investigated consists of 3 sections of gate that will stack on the west end of the opening and roll on tracks to the east. The entry gate will include electrical power and will be provided with an electronic card reader and intercom system connected to the operations office. A picket type iron fence or grille similar to the adjacent Waterfall Park will also be used at the east side of the covered yard area.

The exterior doors to the Maintenance Facility and secure rooms or areas will also be provided with electronic card readers. CCTV surveillance cameras connected to the operations office will be provided at designated locations around the perimeter of the building.

Fire Protection

Fire protection utilities such as hydrants and extinguishers will be provided in accordance with City of Seattle code requirements. The covered yard area will need to be protected by either a dry-type or glycol sprinkler system.

Yard Storage

Outside storage space will be provided in the covered yard area at the south end of the building, for the storage of the following types of equipment and structures: poles, rail, special track-work, other track materials (such as joint bars, insulated joints, etc.). The outside storage area will be screened as required by the City of Seattle.

Refuse and Recycling Collection

Space for refuse and recycling collection including bins and dumpsters will be provided in the covered yard area at the south end of the building. Recycling of paper, corrugated cardboard, glass, plastics and metal will be included to meet LEED requirements. An overhead coiling grille will be provided at the east side of the covered yard area adjacent to the refuse and recycling containers to allow for pick up from the alley.

FACILITY LAYOUT

Design Codes and Standards

The facility design will comply with federal, state and local codes and standards including the following:

- a) 2003 International Building Code with State of Washington and City of Seattle Amendments
- b) 2003 International Fire Code with City of Seattle Amendments
- c) 2003 Washington State Energy Code with City of Seattle Amendments
- d) 2003 International Mechanical Code with State of Washington and City of Seattle Amendments
- e) 1997 Uniform Plumbing Code with City of Seattle and King County Amendments
- f) 2002 National Electrical Code with City of Seattle Amendments
- g) FM Global Insurance requirements (to be determined)

Shop Layout and Functional Requirements

The shop layout will follow certain design guidelines as closely as funds and site configuration permit. These guidelines relate to the relative location of spaces to each other within the shop, areas of the spaces for the type of function, utility requirements, etc.

- a) Grouping of related maintenance activities to simplify workflow and minimize the floor space needed for circulation.
- b) Proximity of support activities and proper industrial engineering will be incorporated to maximize circulation efficiency.
- c) The concrete floor structure will be designed to accommodate jacking with portable jacks at any Streetcar location.

- d) Two maintenance pits will be provided to accommodate all under-car access needs. Services in the pit will include: compressed air, 120 Vac, a welder receptacle, exhaust ventilation, provisions for grating, drainage provisions, approved railings or chains and stanchions, and stairs to access the pits.
- e) Provisions will be made for the future addition of a roof maintenance platform. Services on the platform will include compressed air, 120 Vac, a welder receptacle, approved railings or chains and stanchions, and stairs to access the platform.

Concept drawings are provided for the shop ground level and mezzanine level floor plans. Building sections are provided to identify dimensional relationships of the different floor levels in the building and maintenance facility clearance heights.

The following general functional requirements have been established for the shop and will dictate the types of service and repair facilities to be provided:

- a) Service, remove and replace trolley poles.
- c) Exchange of trucks.
- d) Exchange of defective components with new or rebuilt parts.
- e) Streetcar modifications.
- f) Repair of miscellaneous equipment and components.
- g) Streetcar running repairs.
- h) Periodic maintenance.
- i) Safety inspections.
- j) Interior and exterior cleaning.
- k) Sand box filling.

The following functional areas will be provided in the shop for maintenance and repair purposes:

- a) Storage areas to accommodate small part and general storage.
- b) An area designated for large component storage.
- c) An electrical room for building ac service.
- d) A mechanical/telephone equipment room.
- e) An enclosure for the shop traction electrification breaker / transformer / rectifier.
- f) A component maintenance/storage and repair area will be provided on the first floor level for maintenance and repairs of the heavier Streetcar components.
- g) Provisions for a future 5-ton bridge crane will be provided to remove/replace roof mounted equipment from the Streetcars and for lifting trucks.
- h) A fire sprinkler system will be provided as required by the building code.

The following is a summary square footage for the Maintenance Facility:

- | | |
|------------------|----------------|
| a) Ground Floor: | 8,685 sq. ft. |
| b) Mezzanine: | 2,286 sq. ft. |
| c) Yard: | 2,937 sq. ft. |
| d) Total: | 13,908 sq. ft. |

The facility will not include automatic vehicle wash equipment. Rather, a car position will be provided in the covered yard area adjacent to the shop building for hand washing the streetcars. Provisions will need to be made to capture the wash water in an

oil/water separator prior to disposal to the sanitary sewer system. A washwater treatment and reclaim system will be provided to meet LEED requirements for water use reduction.

A separate dc power supply including a rectifier / breaker / transformer will be provided for the shop. Overhead wire in the shop will be sectionalized to allow the shutdown of power to each of the car positions in the shop without affecting the other. Lockable disconnects will be provided for each car position to allow for safe removal of traction power when required for streetcar maintenance. The shop rectifier / breaker / transformer will be solidly grounded for safety purposes.

DESIGN GUIDELINES

The goal for the Waterfront Streetcar Maintenance Facility design is to provide a safe, efficient, cost-effective facility for the storage and maintenance of the streetcars. In addition the design should provide an attractive work environment for the end users with windows that provide opportunities for the public to view the streetcars inside the maintenance facility. The design should incorporate environmentally sensitive design strategies and materials to meet LEED requirements.

Exterior Materials

The proposed exterior materials include a glazed aluminum curtain wall system with low "e" insulated glass at the east side of the shop. An 8 foot high concrete or CMU base will be provided at the perimeter of the shop for impact resistance, as a washable surface and to support heavy wall mounted loads. Exterior doors will be standard 16 gauge, 3' x 7' painted steel. The exterior envelope will be insulated to meet the Washington State Energy Code with possible strategies to achieve greater energy savings to meet LEED requirements.

Interior Materials

Interior materials will be selected for durability and low maintenance. The materials and finishes used in the shop area and pits will include a light reflective sealer / hardner concrete floor finish. The "All Down" Scheme will require a waterproof traffic coating on the concrete slab to prevent leaks from the Maintenance Facility to the parking garage below. The interior of the perimeter walls above the concrete or CMU base will be furred out using steel studs and gypsum board with fiberglass batt insulation to meet the Washington State Energy Code. The concrete structure and walls above 8 feet will be painted with acrylic latex paint. Concrete or CMU walls below 8 feet and structural steel will be painted with a high performance coating.

The existing 13'-4" wide by 19'-0" high bi-parting vehicle doors and electric operators will be relocated from the existing facility to the south end of the service bays. The existing steel doors will be modified in the shop to include as much glass as possible to maximize natural light and visibility into the shop. Interior doors and frames will standard 16 gauge, 3' x 7' painted steel.

The materials used in the office area will include gypsum board and metal stud partitions, carpet or sheet vinyl flooring and suspended acoustical tile or gypsum board ceilings. Toilets and shower rooms will be finished with ceramic tile floors and walls and suspended gypsum board ceilings. Recycled plastic toilet partitions and benches and steel lockers will be used in the locker room.

Recycled content, low-emitting and local/regional materials will be used wherever possible to meet LEED requirements.

Recycled content materials that may be incorporated include:

- a) Concrete with fly ash
- b) Gypsum wallboard
- c) Acoustical ceiling panels
- d) Carpet
- e) Toilet partitions
- f) Locker room benches

Low-emitting materials that may be incorporated include:

- a) Low VOC concrete form release agent
- b) Low VOC concrete sealer hardener
- c) Formaldehyde free medium density fiberboard
- d) Low VOC fillers and adhesives for resilient flooring and carpet
- e) Low VOC paint
- f) Low VOC coatings
- g) Low VOC tackboard fabric adhesive

Local / Regional Materials manufactured or harvested locally may include:

- a) Concrete products
- b) Cold formed metal framing
- c) Wood products
- d) Steel doors and frames
- e) Aluminum Windows

Building Signage

Building signage will include a lighted exterior sign located on the south side of the building clearly identifying the "Waterfront Streetcar Maintenance Facility". Interior signage will include ADA required room signage and other safety signage required by federal, state and local codes and standards. Floor striping will be provided to clearly identify code required exit aisles in the shop area.

Structural

The building structural system needs to accommodate a 5-ton monorail crane, ½-ton jib crane and a future 5-ton top-running bridge crane. The structure will also need to accommodate the future addition of a roof access platform as indicated on the drawings. A structural steel system to support the rail at the service pits needs to be provided. Stairs and ladders will be painted steel with steel pan and concrete stair treads.

Structural design criteria in the shop will be as follows:

- a) Shop, covered yard and pit concrete floor slab: AASHTO H20-44, light rail vehicle load and 8000 lb. capacity forklift traffic
- b) Mezzanine: 175 psf (dead load plus live load)
- c) Monorail Crane: 5-ton

- d) Jib Crane: ½-ton
- e) Future Bridge Crane: 5-ton
- f) Future roof access platforms: 175 psf (dead load plus live load)

Trackwork

All new track will be constructed using an Ri59 girder rail section. Girder rail provides the following benefits: flangeway protection, simplified and robust stray current control solutions, lower cost for track crossing.

All turnouts will conform to European designs for 25m (82 ft.) radius switches with either straight or curved frogs. Turnouts will be installed inside an insulated concrete "bathtub" to minimize stray current leakage. Turnouts will be manually operated and will not be insulated for signaling circuits. Turnouts will be connected to existing 115 RE mainline rails by using a machined transition rail piece at the toe of each turnout. The transition rail will be field welded to the existing mainline rail. Moveable switch tongues will be electrically bonded to switch running rails.

Tracks outside of the maintenance building will be embedded in an 8 ft. wide concrete slab. A rubber "boot" will be placed between the rails and concrete to minimize stray current leakage.

Tracks inside the maintenance building will be embedded in a structural concrete floor slab (floor slab to be designed by building architect). It is assumed that a rubber "boot" will be placed between the rails and concrete to minimize vibrations and stray current leakage.

Tracks over maintenance pits will be clamped to steel I-beams using rigid clips. Clips and rails are included in trackwork designs, I-beams and other supports are included in pit designs.

Lighting

- a) General lighting levels will be as follows:

Shop Areas	50 FC
Pit Areas	100 FC
Mezzanine Equipment Rooms	50 FC
Office and Rest Rooms	75 FC

- b) Lighting for specific task areas will be located and designed to meet specific tasks.
- c) Shop areas will utilize energy efficient high bay fluorescent lighting.
- d) Support areas, pits and storage will utilize fluorescent lights.
- e) Pit lighting will be rated to comply with the electrical code for Class 1, Division 2 Electrical Hazard Classification, with impact resistant lenses.

Corrosion Control and Safety Grounding

The streetcar shop will have an equipotential grounding system for all surfaces exposed to human contact. This will be accomplished through use of a perimeter ground loop. The ground loop will be bonded to ground rods and solidly tied to building structural members and concrete reinforcement bars. The concrete reinforcement will be bonded in a grid pattern and tied to the rails. Insulated joints will be placed in the rails at a location near the building doors to be determined in final design. The insulated joints will define the extent of the building grounding system.

DC stray currents are prevalent in the yard and shop area. Accordingly, all subgrade ferrous pipes will be coated with an electrical insulating material, bonded around some joints and equipped with insulated couplings at other joints. Plastic pipe will be used where it meets with code requirements in order to minimize the potential for stray current corrosion.

Mechanical Systems

Shop areas will be provided with heating and ventilation similar to a warehouse. Mechanical ventilation of the shop will be provided by large louvers located on the east wall of the shop above the vehicle doors. In addition to the mechanical ventilation of the Shop, operable windows will be provided for natural ventilation to meet LEED requirements.

The heating system will be designed for a temperature of 65 degrees F. The system will be designed using gas fired radiant heat. The under car service pits will be provided with wall mounted hot water radiant heat and exhaust air ducts at side walls. The exhaust system in the pits shall be capable of handling pressure washing to minimize and control steam accumulation in the shop. Additional exhaust will be needed for the welding hood, small parts paint booth, bead blaster and belt disc sander. Additional make-up air will be needed for the small parts paint booth.

Shop compressed air will be provided at convenient intervals to operate tools in the services pits, in the component repair area, on the mezzanine, at the covered yard area and will be stubbed out for the future roof access platform.

Floor drains and / or trench drains will be provided at the covered yard area, service pits, toilet rooms and mechanical room. The covered yard area and service pit drains will be connected to oil / water separators to remove contaminants prior to disposal to the sanitary sewer system.

The offices, toilets, break room, and locker room will be provided with a forced air heating, ventilating and air conditioning system located in the mechanical room.

Electrical Systems

Electrical service will be provided for the building at 480 vac, 3 phase and transformed to 120/208 volts for the building services. The 480 volt service will feed the DC power supply. Power outlets will be provided in the shop area at streetcar positions, component repair and maintenance areas at 120 volts for convenience outlets, and at higher voltages for welder and portable jack outlets. Electrical interlocks will be provided for the overhead wire and crane operation. An auxiliary power supply may need to be provided for powering the Streetcar at the roof access platform in the future. Electrical power in the offices, toilets, breakroom and locker room will be standard 120 vac typical for these uses. Convenience outlets located in the service pits will be rated to comply with the electrical code for Class 1, Division 2 electrical hazard classification.

Fire Alarm

Fire alarm will be provided as required by the 1997 Uniform Fire Code (UFC), Volume I and Volume II, and as required by applicable state and local codes. Specific design criteria for fire detection and alarm systems shall comply with all applicable

sections of NFPA 72. System will call into a main fire alarm panel located point of fire department response. System will include initiating devices (duct detectors, pull stations, fire protection monitoring devices, etc.) and annunciations devices (horns and horn/strobes) in conformance with ADA requirements. King County Metro Transit has standardized on the Edwards System Technology (EST) Fire Alarm Equipment and have currently specifying the third generation (EST3) of this equipment for our facilities.

Communications

The Developer shall provide all data communication station wiring (CAT-5e) between the computer workstation (or remote terminal location as applicable) interface jacks (Modular RJ-45) and the patch panels at the Main Distribution Frame/Intermediate Distribution Frame (MDF/IDF) location.

The Developer shall provide voice telecommunication station wiring, similar to above, using Category-3 (CAT-3) UTP (Unshielded Twisted Pair) cable and RJ-11 modular interface jacks.

Incoming Wide Area Network (WAN) and Telecommunications service to the facility shall be per King Co. Information & Telecommunication Services (ITS) Division requirements.

Security Access Control

The Developer shall provide raceways and power for a card key access system. Wiring, components, and devices will be provided by King County through an outside supplier.

Provide keypad access controls and induction loops for each motorized vehicle gate location. Provide power connection for gate operator.

Provide security intrusion alarm system per King County facility standards and as otherwise required. Provide magnetic door contacts at exterior entry doors and audio/motion sensors in office areas. Provide arm/disarm keypads at building entry points. Provide individual zones as required by functional program.

Provide conduit and mounting provisions for Owner furnished and installed Closed Circuit Television (CCTV) monitoring system. Provide power at equipment rack locations.

Intercommunications and Public Address

A zoned public address (PA) system shall be provided, which gives adequate sound reinforcement and audibility in all areas throughout the compound. Provide an all-call zone, and one zone for each segregated public building area or functional group, and one exterior paging zone.

Additionally, an intercommunications system shall be provided as part of the telecommunications switching equipment. Intercommunications shall be accessible by dialing unique extensions within the facilities telephone system. Public Address zones shall also be available by telephone system extension.

Each speakers zone shall include a separate amplifier system output volume control, as well as an adjustable volume control for each room or area, for example corridors and offices on the same zone will require a different speaker volumes, as will shop spaces, and likewise the exterior spaces around the building.

Provide intercom extension to the gate to allow persons outside of the gate to call into the facility.

Cable TV

A raceway will be provided to extend cable TV to the facility via the electrical room.

EQUIPMENT

Existing Equipment

A schedule of existing maintenance facility equipment has been developed for the purposes of identifying each item, its size, and, where possible at the time, its utility requirements such as electrical power, air, water, etc. It is Metro's intent to relocate most of that equipment to the new facility as space allows and per the conceptual floor plans. Metro staff will handle the relocation and installation. The General Contractor will provide utilities to the locations for connection. See "Existing Maintenance Facility Equipment Schedule" attached to the end of this document.

New Equipment

New equipment that will be required includes the following items that are to be purchased and installed by the General Contractor based on specifications approved by Metro:

- a) 5-ton Monorail with electric trolley, electric wire rope hoist and remote radio control
- b) 1/2-ton Jib Crane including post, 20-foot boom, electric trolley, electric wire rope hoist and pendant control
- c) Provisions for a future 5-ton Bridge Crane with electric trolley, electric wire rope hoist and remote radio control
- d) 2500 lb. capacity, 2-stop, hydraulic passenger elevator to comply with ADA code requirements
- e) Fall protection system for the two western track vehicle positions
- f) Washwater treatment and reclaim system in the covered yard area.

COST ESTIMATES

The following rough order of magnitude cost estimates have been included for special systems associated with the Waterfront Streetcar. The cost are direct construction costs and do not include general contractor overhead & profit, general conditions, design & permitting costs, design contingencies, sales tax or inflation / escalation factors.

a) 700 lineal feet of Building Trackwork:	\$ 280,000
b) 3 Turnouts:	\$ 375,000
c) 1 Track Crossing	\$ 125,000
d) 2000 lineal feet of roadway demolition & regrading	\$ 30,000
e) New Inlet	\$ 2,000
f) Sanitary Sewer Manhole Modifications	\$ 5,000
g) Traffic Control (with closure of westbound traffic on Main Street)	\$ 10,000
h) DC Power Supply (Rectifier / Transformer / Breaker)	\$ 200,000
i) Overhead Contact System	\$ 215,000
j) Corrosion Control & Grounding Allowance	\$ 10,000
k) DC Electrical Testing	\$ 10,000
l) 5-ton Monorail & Runway	\$ 25,000
m) ½-ton Jib Crane (20-foot boom) (Does not include foundation)	\$ 11,500
n) 5-ton Bridge Crane and Runway	\$ 50,000
o) Interlocks for Monorail & Bridge Crane	\$ 14,000

**Waterfront Streetcar
Existing Maintenance Facility Equipment Schedule**

Item Number	Description	Quantity	Manufacturer & Model	Utility Characteristics	Size
West track - SW Wall					
1	Jack Stands	4	Transpo	-	2' 8" square space
2A	Vehicle Jacks and controller	5	Transpo; WL TL 54-6	8hp 208/230V 3 ph.	3' 6" W X 3' 9" D
3	Portable air pump grease gun	1	-	CA	2' X 2'
4	150 Ton hydraulic press	1	Dake 6-650	-	22" Dia.
5	Oxy/Acy cart and bottles	1	-	-	5' 8" W X 4' 0" D
6	Bench & Disk / Belt Sander	1	-	-	1' X 4" W X 2' 0" D
7	Pedestal Grinder	1	Baldor, 1215 W	1 1/2hp 115 / 230V 12.8 / 6.2A	-
8	Drill Press Electrical?	1	Alzmetal AB4 SV	2 hp 1ph 208-230v / 460v	2' 10" D X 5' 0" W
9	Work Bench	1	-	115 V 1ph CA	4' 2" D X 2' 6" W
10	Metal Work Bench with Vise & Arbor Press	1	-	-	2' 10" D X 6' 0" W
11	3 ton Jlb Crane	1	-	30 A, 20 hp, 3 ph, 15 hp, 3ph	4' 0" X 8' 0" W
Electrical Shop					
12	Work Benches	2	-	115 V / 230 V 1ph + 3 ph	3' X 6'
13	Wall Mounted Pegboard	1	-	-	12' X 4' above work benches
14	Battery Pallet	1	-	-	-
15	Open Shelves	4	-	-	12" X 36" X 7' H
16	Rolling Grease Drum - hand pump	1	-	-	22" dia
17	Portable Gas Fired Pressure Washer	1	-	-	2' W X 3' L, Rolling
Parts Room					
18	Open shelving	3	-	-	1' 6" D X 3' 0" W X 7' 1" H
19	Open stock bin	1	-	-	1' D X 2' 10" W X 6' 8" H
20	Mod Drawer Units	2	Lista	-	2' D X 2' 4" W X 4' H
21	Wardrobe Rack	1	-	-	2' D X 3' H X 6' 8" H
22	Work Center	1	-	-	2' 6" D X 4' L for keyboard and screen
23	Computer Work Station	1	-	-	2' 6" D X 4' L for CPU, Keyboard & Monitor
24	Mod Drawer Units	1	Stanley Vidmar	-	2' 6" W X 2' 4" D X 5' H
25	Open stock bin	1	-	-	12" D X 36" W X 6' 8" H
Office/Break Room					
26	Drawer Cabinet	1	-	-	12" D X 3' W
27	Book, Catalogue Shelving Units	3	-	-	12" D X 2' 6" W
28	Credenza	1	-	-	5' 3" X 1' 8"
29	Desk	1	-	-	2' 6" X 5' L

**Waterfront Streetcar
Existing Maintenance Facility Equipment Schedule**

Item Number	Description	Quantity	Manufacturer & Model	Utility Characteristics	Size
30	Table	1	-	-	7' X 3'
31	4 drawer file cabinet	1	-	-	20" W X 2' 4" D
32	TV	1	-	-	-
33A	Chairs Guest	4	-	-	-
33B	Chairs Office	1	-	-	-
Mezzanine					
34	Shelf Units	5	-	-	3' 7" W X 2' 6" D X 7' H
35	Shelf Units	16	-	-	3' W X 2' D X 7' 3" H
36	Open Wood Shelf Units	3	-	-	5' W X 2' D 6' H
37	Pallet Jack	1	-	-	2' 6" W X 4' 6" D -rolling
38	Air Compressor - 200 psi	1	Marathon 184 TT DR 762 - 7ACL	206 V	-
39	Air Dryer	1	Zurn RF25	-	-
40	Pallets	5	-	-	4' X 4' Each
Center Bay					
starting at E wall north working S					
41	Wire wheel / grinder	1	Stanley 650	115V 1ph 13A 1 HP	2' 8" X 2'
42	ArcWelder - wants to add wire feed	1	Airco	250A 1ph	36" X 24"
43	Rolling Steel Bench with Vise	1	Wilton 656	-	60" X 36"
44	Rolling Tool Box	1	-	-	1' X 3' D X 4' 6" W
45	Band Saw	1	-	-	?
46	Lathe need 1/2 ton crane electrical	1	Star Cadillac 1780	15 hp ?	11' W X 3' D
47	Work Bench	1	-	-	3' D X 6' W
48	50 Gallon drums	3	-	-	20" In dia. Each
49	Storage Cabinet for Flammables	1	-	-	20" D X 3' 8" W
50	Parts Cleaner	1	-	-	3' 2" H X 2' D X 3' 9" W
51	Rolling High Lift	1	Genie GS 1930	-	6' 8" H X 6' 0" W X 2' 6" D
52	Forklift	1	Daewoo Plus 630P EXF 128	Propane powered	12' 6" W X 4' 0" D
53	Rolling Ladder	1	-	-	11' 4" H X 6' 0" W X 2' 4" D
54	Paint Booth & Electrical Exhaust fan	1	-	-	3' D X 6' H X 6' 3" W
East Track					
North to South					
55	"Mean Steamer" Electrical, CA, plbg in roof	1	Deico code #000751 382 1198 SN	high/low Ext louvers, electric, plumbing	22" dia
56	50 gal soap drum	1	-	-	22" dia
57	50 gal trash	1	-	-	20" D X 6' W
58	Grit storage rack to hold 50lb "Triviro" bag	1	-	-	-
59	50 gallon drums	4	-	-	-
60	Bead Blaster	1	Econoline 30-0 with Torit Model PP	CA + 230/460V 3ph 1.5hp	-
61	Rack to hold ice melter	1	-	-	20" X 12'
62	Pallet rack	1	-	-	3' 6" X 10' 6" W, posts 10' H

**Waterfront Streetcar
Existing Maintenance Facility Equipment Schedule**

Item Number	Description	Quantity	Manufacturer & Model	Utility Characteristics	Size
63	Shop Vacuum	1	Advance GW 4512	115v	1
64	Shelf Cabinets	2	-	-	32" W X 21" D X 7' H
65	Advance Floor Sweep	1	Convertamax 20	-	2' 6" X 6'
66	Wood Door Cabinet	1	-	-	24" W X 24" D X 7' H
67	Door Storage Cabinet	1	-	-	4' W X 2' D X 6' 6" H
68	Door Storage Cabinet	1	-	-	3' 6" W X 2' D X 6' 6" H
69	Door Storage Cabinet	1	-	-	3' W X 1' 6" D X 6' 6" H
Building Electrical?	400 AMP on East wall of Central Bldg	5 KVA Transformer	200 AMP in addition	Overhead door operators (6)	30 AMP 480 V 3 ph

200 Occidental

Civil Narrative Seattle, Washington

August 25, 2005

INTRODUCTION

The 200 Occidental project is located in the South Downtown area of Seattle. The project is bounded by South Washington Street to the north, Occidental Avenue to the east, South Main Street to the south, and an Alley to the west.

DESIGN CRITERIA AND CODES

1. City of Seattle Standard Plans for Municipal Public Works Construction, 2005 Edition
2. City of Seattle Standard Specifications for Municipal Public Works Construction, 2005 Edition
3. City of Seattle Street and Sidewalk Pavement Opening and Restoration Rules, Director's Rule 94-8, 1998 Revision
4. City of Seattle Construction Best Management Practices Manual, Director's Rule 16-2000
5. City of Seattle Source Control Technical Requirements Manual, Director's Rule 17-2000
6. City of Seattle Stormwater Treatment Technical Requirements Manual, Director's Rule 27-2000
7. City of Seattle Stormwater, Grading and Drainage Control Code, 2000 Edition
8. City of Seattle Street Improvement Manual, 1991 Edition
9. Seattle King County Department of Public Health
10. Applicable Seattle Department of Transportation (SDOT) requirements

11. Private utility connections:
 - a. Puget Sound Energy
 - b. Seattle City Light
 - c. US West
 - d. Cable
 - e. Seattle Steam

DEMOLITION

On-site demolition will include the removal of the existing parking lot asphalt pavement and miscellaneous utilities and appurtenances both underground and above ground.

Off-site demolition will include existing sidewalks, curbs, and other appurtenances within the public right-of-way as required for construction of off-site improvements. No demolition within the public right-of-way shall commence until the SDOT Street Improvement Plans have been approved.

TEMPORARY EROSION CONTROL

The Construction Best Management Practices to be employed during the excavation shall include a rock construction entrance, sedimentation barrier, catch basin inserts, rock check dams, a concrete truck and pump washout area, and a temporary sedimentation pond or tank.

TEMPORARY EXCAVATION

Current designs under consideration include two scenarios for temporary excavation.

The first option, commonly referred to as the "shallow" or "all up" option would involve nominal shoring with only localized shoring elements required to install streetcar maintenance pits.

The second option, commonly referred to as the "deep" option will require a temporary excavation shoring system to facilitate basement construction adjacent to the property boundaries. This system will require coordination with regard to the existing street utilities, adverse soil conditions due to the watertable, and new basement depths. The shoring will extend to one foot below the bottom of the structural perimeter foundations. There is approx 30,000 square feet of shoring anticipated at this site with the current deep option.

Construction dewatering may be required depending on shoring method.

PAVING

The off-site development will include the replacement of existing concrete sidewalks and curbs. Concrete sidewalks, curbs, and paving required for curb installation in the public right-of-way will be in accordance with the City of Seattle Standard Plans, Type 420, 410C and 402B, respectively. Pavement patching required for utility installation will be in accordance with the City of Seattle Standard Plans, Type 404a.

GRADING

See C4.00 for grading for this project. These are set in accordance with SDOT requirements.

DRAINAGE

A foundation drainage collection system may be required pursuant to geotechnical recommendations. If required, this system would be routed through a catch basin below the lowest basement-level slab, before connecting to the mechanical system. In the shallow design, we anticipate this system to drain to the city by gravity. If the deep design is opted for, this system will need to be pumped to the City's existing combined sewer system. There are combined sewer lines on South Washington Street (18"), South Main Street (28"X42" oviform) and the Alley (12").

Off-site surface drainage will be accomplished by installing new concrete curbs and regrading of existing flow patterns, as required, to direct off-site drainage to new inlets shown on the civil drawing. The existing inlets are to be replaced as required by SDOT.

On-site surface drainage consists of surface drainage swales, trench drains, area drains and catch basins. All on-site surface stormwater is captured by these drainage structures and routed to the stormwater detention tank.

STORM WATER

Stormwater will be collected via mechanical piping for the building structures as well as the on-site surface drainage mentioned above. Stormwater will then be routed to the 1,975 cubic foot detention tank located under the lowest floor or inside the parking levels in an otherwise unused space. The detention tank will outfall by gravity to the City's existing PS main in South Washington Street.

Cisterns in the urban environment are usually located under the bottom floor slab or in unused areas of the parking levels. Cisterns serve to capture roof runoff for reuse in irrigation of onsite landscape elements. Reusing rainwater for irrigation purposes reduces demand on the public water supply. This reduction of water demand is used as a basis to pursue a LEED credit. The cistern overflow will route to the detention tank via surface drainage features or underslab piping depending on the project program. Site-specific cistern sizing is yet to be determined. For costing purposes, we've chosen a 2,000 cubic foot cistern.

Cost estimate as follows:

Service	Quantity	Unit	Cost Per Unit	Total
Cistern Pipe (2,000 CF)	1	ls	\$24,000	\$24,000
Stormwater Detention Vault Structure (1,975 CF)	1	ls	\$40,000	\$40,000

UTILITY CONNECTIONS

Domestic and Fire water service connections will most likely be on the South Washington Street frontage. There are vault clearance concerns on Occidental Avenue and South Main Street has limited available space in the sidewalk due to required streetcar access. For initial pricing purposes we assume a 4 inch domestic service and an 8 inch fire service. The water services for this project will be sized by mechanical at a later time. See table below.

The Storm Drainage and Sanitary Sewer connection will be made on the South Washington Street frontage.

SDOT will require two 2-inch and one 3-inch conduits to be placed under the new off-site concrete sidewalks for street lighting and traffic signalization. There will also be requirements for additional handholes and/or junction boxes. SDOT may also require some conduits to be routed across adjacent streets to existing handholes and/or junction boxes.

Service	Quantity	Unit	Cost Per Unit	Total
Domestic Water Service – 4-inch service	1	ls	\$23,800	\$23,800
Fire Water Service – 8-inch service	1	ls	\$37,445	\$37,445
Storm Drain \ Sanitary Sewer Connections to the City Main	1	ls	20,000	20,000

PUBLIC AGENCY COORDINATION

Street Improvement Plans will be issued under a separate submittal to SDOT. These drawings will consist of the work to be done within the public right-of-way. SDOT will review and approve these

drawings for construction. A 33 percent design submittal will occur at the time of the project MUP submittal to DPD and will be under a separate submittal to SDOT. Comments from this submittal will be incorporated into full SDOT Street Improvement Plans (SIPs) will occur at the time of the building permit submittal to DPD and will be under a separate submittal to SDOT.

SUSTAINABLE OPPORTUNITIES

STORM WATER

There are several alternative stormwater management opportunities that are worth considering for this development. Among these alternatives are Eco-roofs (a.k.a. Green Roofs) and surface ponding

Eco-Roofs

Eco-roofs provide a number of benefits. The stormwater flow reduction offered by eco-roofs contributes to meeting LEED requirements for stormwater management, and may allow the detention tank size to be reduced. Eco-roofs also can reduce the heating of the rooftop, extending the life of the roof and reducing HVAC demands for the building. Eco-roofs also provide improved aesthetics, air quality benefits, and enhance the urban ecosystem.

These techniques typically have associated cost premiums over and above the conventional detention tank. The benefits and cost premiums of alternative stormwater management techniques should be further considered in conjunction with the goals and objectives of the project

Surface Ponding

Surface ponding is exactly what the name implies. Stormwater is allowed to pond on dedicated portions of roofs. Quantifying this amount of stored water can in turn allow a reduction in the size and expense of underground detention tanks.

STRUCTURAL DESIGN NARRATIVE

PROJECT LOCATION

The 200 Occidental proposed development is located in downtown Seattle, adjacent to Occidental park and between Washington Street and Main street. Presently the site is occupied by an on-grade parking lot. The scope of this narrative is to describe and quantify the structural schemes that are proposed. Currently there are two schemes being proposed both have residential on the upper floors. The first scheme is the "All-Up" scheme which has all parking above grade and no basement. The second scheme is the "All-Down" scheme which has all the parking below-grade.

For both schemes, the project is to consist of the following uses and square footage requirements:

Housing	150,000 sf.
Parking	85,000 sf
Retail/Lobby	16,000 sf
Streetcar Maintenance	12,000 sf

At grade level, the Streetcar maintenance facility is proposed. There are specific loading and framing requirements for this use. These criteria have been provided by King County Metro and their architect, Waterleaf. Specific issues that impact the structure not typically required for a residential project will be addressed in the following sections.

CODES AND STANDARDS

All construction shall be in accordance with the 2003 International Building Code (IBC 2003) and the 2002 American Society of Civil Engineers Minimum Design Loads for Buildings and Other Structures (ASCE 7-02). The publications listed below are the governing codes and standards and are referenced by the basic designation. In case of conflicting requirements, the IBC shall govern. We propose that the seismic design be in accordance with the 2005 AISC Seismic Guidelines and the 2006 IBC seismic provisions.

Code/Standard Description	Description
IBC 2003	International Building Code, 2003 (2006 for seismic design)
ASCE 7-02	American Society of Civil Engineers Minimum Design Loads for Buildings and Other Structures, 2002
AISI NASPEC 2001	American Iron and Steel Institute North American Specification for Design of Cold-Formed Steel Structural Members, 2001 Edition
ACI 318	American Concrete Institute Building Code Requirements for Structural Concrete, 2002 Edition

Code/Standard Description	Description
ACI 530	American Concrete Institute Building Code Requirements for Masonry Structures, 2002 Edition
AISC LRFD 1999	American Institute of Steel Construction Load and Resistance Factor Design Specification for Structural Steel Buildings, 1999 Edition
AISC 341-02	American Institute of Steel Construction Seismic Provisions for Structural Steel Buildings, 2002 Edition

FOUNDATION CRITERIA

The foundation concepts have been based on the preliminary geotechnical investigation prepared by Shannon and Wilson dated November 2, 2000. The geotechnical report was done for an earlier development project that was never built. The recommendations have been followed where appropriate. Supplemental information has been provided by Tom Gurtowski with Shannon and Wilson.

ALL-UP SCHEME

The foundation is to consist of a pile supported mat foundation. The borings from the site, indicate that there is a lot of fill material in the upper 10 feet. This consists of rubble, sawdust, wood chips, etc. Therefore, it is recommended that large shaft caissons (3 foot diameter) be used under the building columns. The soils vary with depth across the site, but conservatively the dense bearing material is at 40 feet below existing grade. The interior building columns that support residential floors will require penetration into the dense soils approximately 40 feet for a total depth of 80 feet. The perimeter columns and parking only columns will require a casing penetration of 30 feet into the dense soils for a total depth of 70 feet.

The mat foundation will consist of 12-inch thick concrete typically. In the areas under the streetcar maintenance floor, provide a 15-inch thick concrete mat. It is assumed that a 4-inch topping slab will be used over the mat for the finished floor. There are two large maintenance pits required. They are approximately 12 feet wide by 5.5 feet deep with the length shown on the drawings. The pit walls will be used as grade beams to frame the pits to the columns.

ALL-DOWN SCHEME

The required depth for the below-grade parking will locate the garage foundations on the dense material with a bearing capacity of 15 ksf. For this scheme, spread footings and mat foundations will be required. Depending on the lateral system selected, the foundation system will vary. If a concrete core wall system is used, a mat foundation under the core walls will be required. This will range on the order of 4-6 feet thick. An all moment frame scheme will not require large mat foundations as the all-core wall system. For gravity columns that are continuous through all the residential and parking levels, footings approximately 10' x 10' x 3' deep will be required. The basement wall footing will be an eccentric "L" footing approximately 4 feet wide and 2'-6" deep.

The below-grade excavation will require a secant pile system or equivalent system to allow excavation below the water table. The existing water table is approximately 10 feet below grade. A secant pile system that allows this "bathtub" construction is proposed. The thickness and reinforcing for the

basement wall will depend on whether or not the shoring system is permanent or temporary. If the shoring system is temporary, the basement wall will need to be designed to support the lateral soil pressures. Assume a basement wall thickness of 12 to 14-inches with two curtains of reinforcing. For the permanent shoring condition, the basement wall will not have to support the lateral soil pressures and assume a basement wall thickness of 8 inches with a single curtain of reinforcing.

LOADING CRITERIA

A summary of the project-specific loading criteria follows. This loading meets or exceeds the requirements stated in the IBC.

GRAVITY LOADS

Table 1. Residential Area (R)

Element	Load
Dead Load (self weight of structure, plus:)	
Mechanical/Electrical/Plumbing	3 psf
Floor Finish and Ceiling	5 psf
Partitions	20 psf
Live Load (reducible)	
Residential Typical	40 psf

Table 2. Residential Balcony (B)

Element	Load
Dead Load (self weight of structure, plus:)	
Floor Finishes	5 psf
Live Load	
Balcony	60 psf

Table 3. Roof (RF)

Element	Load
Dead Load (self weight of structure, plus:)	
Mechanical/Electrical/Plumbing	3 psf
Waterproofing, Surface Topping, etc.	25 psf
Live Load	
	60 psf

Table 4. Lobby, Corridor, Stair, and Exit Facilities (C)

Element	Load
Dead Load (self weight of structure, plus:)	
Mechanical/Electrical/Plumbing	3 psf
Floor Finish and Ceiling	5 psf
Partition	20 psf
Live Load (nonreducible)	
Exit Facilities	100 psf

Table 5. Mechanical/Electrical Room (M)

Element	Load
Dead Load (self weight of structure, plus:)	
Mechanical/Electrical/Plumbing	5 psf
Floor Finish and Ceiling	5 psf
Partitions	10 psf
Live Load (non-reducible or equipment weight, whichever is greater)	125 psf

Table 6. Steetcar Maintenance (S)

Element	Load
Dead Load (self weight of structure, plus:)	
Mechanical/Electrical/Plumbing	3 psf
Floor Finish and Ceiling	40 psf
Live Load (nonreducible)	
Maintenance/ HS-20	200 psf

SEISMIC DESIGN COEFFICIENTS FOR SEISMIC FORCE RESISTING SYSTEMS.

Where combinations of systems occur in the same direction, the more stringent design coefficients are used.

Building Frame Concrete Shear Wall Systems	
Special Reinforced Concrete Shear Walls	$R=5.5, \Omega_0=2.5, C_d=5$

Core Wall with Special concrete moment frames (Dual System)

$R=8, \Omega_o=2.8, C_d=5$

MATERIALS

CONCRETE STRENGTHS

For concrete strengths, we assume the "normal weight" is typical at 145 pcf.

Pile Caps/Footings	$f'_c = 4,000$ psi at 28 days
Mild-Reinforce Slabs	$f'_c = 5,000$ psi at 28 days
Post-Tensioned Slabs and Beams	$f'_c = 3,000$ psi at 3 days $f'_c = 5,500$ psi at 28 days
Gravity Columns	$f'_c = 5,000$ psi at 28 days
Shear Walls/Basement Walls	$f'_c = 5,000$ psi at 28 days
All Other Concrete	$f'_c = 4,000$ psi

CONCRETE REINFORCING STEEL

ASTM A615	Grade 60	$F_y = 60,000$ psi
ASTM A706	Grade 60	$F_y = 60,000$ psi

POST-TENSIONING TENDONS

ASTM A416	1/2-inch diameter 7-wire strand	$F_y = 270,000$ psi
-----------	---------------------------------	---------------------

STEEL

Wide Flange Shapes	ASTM A 992	$F_y = 50$ ksi
	ASTM A 913	$F_y = 50$ ksi
All Angles UNO	ASTM A 36	$F_y = 36$ ksi

Square or Rectangular Tubes	ASTM A 500 Grade B	Fy = 46 ksi
Pipe with Diameter	ASTM A 53 Type E or S	Fy = 35 ksi
Material Called Out As (A36)	ASTM A36	Fy = 36 ksi
All Other Steel	ASTM A572	Fy = 50 ksi
	ASTM A588	Fy = 50 ksi
	ASTM A441	Fy = 50 ksi

STRUCTURAL SYSTEM

GRAVITY SYSTEM

The structural frame will be all-concrete construction, with post-tensioned (p-t) slabs. Compared to other alternatives, this type of construction will allow a thinner structural depth over the majority of the unit's floor plan. The base-line scheme with the atrium in the center of the building will have typical unit sizes of approximately 38 feet deep and 26 feet wide. This results in a framing scheme with wide shallow p-t beams spanning the 38 foot dimension with a p-t flat plate spanning between the beams. The same framing scheme will be used for the residential portion for either the "all-up" or "all-down" schemes. The specifics related to each scheme are provided in the following sections.

The atrium residential plan at the penthouse level indicates the building's exterior skin steps back from the perimeter of the typical exterior. The framing above this level may be steel framing to reduce the dead load. The columns that step back will require transfer from the floor framing below. The typical wide shallow beam will need to be increased in depth and reinforcing (assume 3" of additional depth and 25% additional reinforcing).

ALL-UP SCHEME

The residential floors will be wide shallow pt-beams 48" wide by 18" deep to span the 38 foot dimension. A 7" p-t slab will span between the wide shallows as shown on the structural drawings S-3.

For the parking levels, a similar framing scheme as the residential floors will be used. Refer to the structural drawings on S-2. The 38 foot span requires no intermediate columns in the units or in the parking stalls for this scheme. This framing will result in the lowest level of parking over the streetcar maintenance will not have to be designed as a transfer slab. The column grid can continue into the maintenance area and allow the width required for an overhead crane in this area.

The first level will be a pile supported mat foundation as shown on the structural drawing S-1. Refer to the Foundation Criteria section for a description of the foundation. Assume a topping slab will be used as a finish over the mat foundation.

ALL-DOWN SCHEME

The residential floors will be the same as described in the "all-up" scheme. Refer to the structural drawings S-3.

The lowest level of the residential floors will also serve as the "roof" of the maintenance portion of the building. The column grid will enable the columns to continue through the maintenance facility and not require this slab to be designed as a transfer slab. However, this slab is expected to be landscaped in the courtyard area of the atrium. Allowances in the cost estimate should be made for additional concrete thickness (assume 3" in this area with approximately 25% additional reinforcing than the typical slab).

The framing scheme for the parking below grade is to be a 10" mild-reinforced flat plate. Interior columns have been provided adjacent to the basement walls to reduce the slab span. These columns will be 12" x 24" to fall within the allowable parking stall space. Refer to structural drawing S-4 for framing plans.

LATERAL SYSTEM

The two proposed schemes, the space requirements for the streetcar facility, and the residential scheme(s) can impact the type of lateral system selection. Two different lateral systems and a combined system are presented below.

The first lateral scheme is an all concrete core wall layout. For this size floor plate and building height, the length of walls required would be on the order of 100 to 120 feet of 24" concrete walls in both directions. The walls would also need to be evenly distributed within the floor plate. The current architectural layout for the vertical transportation requirements does not provide enough core walls. The challenges associated with finding additional walls will be the ability to find a common vertical alignment through the residential/parking/streetcar facility's programs. The biggest challenge will be to find enough length of wall in the short dimension of the plan (i.e., the east-west direction). This is further limited by the fact that the streetcar facility will not be able to accommodate a concrete core wall in the east-west direction within their space due to the path requirements for the streetcar rails.

The second lateral scheme is an all concrete moment frame. For this size floor plate and building height, the required number of frames would be approximately 12 frames in each direction. This would include almost all of the columns on the perimeter along the north-south perimeter of the building. The approximate column sizes would be on the order of 36" x 42" and the beam depth of approximately 42". To minimize the depth of the beam below the slab soffit, these beams would most likely need to be "upset" so that the beam depth can form the top of the window sill. The biggest challenges for this system will be accommodating frames in the east-west direction. The structural grid of 38 feet, would require additional columns within this span to have effective frame action and maintain a reasonable beam depth. This can be particularly challenging for the "all-up" scheme at the parking levels.

The third option would be to consider a combination of the first two schemes either as a "Dual System" or a combination of moment frame in the north-south direction and core walls in the east-west direction. For the dual system, the same general requirements for both schemes are required, but with reduced quantities for each. For a dual system, the core wall length requirements could be reduced approximately 25% in each direction and the size requirements of the moment frames could be reduced to sizes on the order of 24" or 30" square columns with beam depths approximately 30" deep.

STREETCAR MAINTENANCE FACILITY

The criteria required for the maintenance facility has been provided by King County Metro and their architect, Waterleaf. The streetcars will require two pits for maintaining their streetcars. Accommodations for the modern streetcars will require one of the pits to be longer than the existing streetcar. The rails over the pits will require steel columns and beams to support the rails in the pit area. Similar framing as provided in the existing maintenance facility would be required in this facility.

The maintenance facility will typically be at a lower elevation than the lobby and retail areas. Unit cost allowances for stepping the slabs or the mat foundation should be provided in the cost estimate. In addition, the "yard" area of this facility will need to be sloped to drain. This could be done with the structure or a topping slab. The rails will also need to be flush the adjacent slab and will require recessing in the slab. The structured slab or mat will need to be recessed and thickened locally under the rails. The loading in this area will require a heavy live load. There are to be floor jacks capable of lifting one of the modern streetcar's "trucks". The modern streetcars are expected to weigh

approximately 70,000 pounds. The structure for both schemes has been thickened in these areas to accommodate the higher live loads.

Three-hour separation walls will be required between the maintenance facility and the retail space. This is expected to consist of a solid-grouted 8" CMU.

Cost allowances are needed for a corbel from the columns to accommodate a future crane rail. According to Waterleaf, the rail vibrations can be isolated from the main structure columns by the future crane rail and should not require a separate structure to isolate the vibrations.

In addition, further study will be required to evaluate the possible need to mitigate vibrations in the building due to the streetcars. The "all-down" scheme appears to be the most susceptible to these vibrations, however, cost allowances for vibration mitigation should be made for both schemes.

QUANTITIES

Element/Type	Reinforcement	PT	Comments
Post-Tensioned Slabs			
Typical residential floors	2.2 to 2.6 psf	0.75 to 0.9 psf	
Typical parking floors (all-up)	2.2 to 2.6 psf	0.75 to 0.9 psf	
Mild-reinforced Slabs			
Typical parking floors (all-down)	4.5 to 5.5 psf	N/A	See Note 2
Level 1 slab Retail/Lobby (all-down)	5.0 to 6.0 psf	N/A	
Level 1 slab Streetcar Maintenance (all-down)	6.0 to 7.0 psf	N/A	
Gravity Columns			
Typical residential tower Columns	450 lbs/cy	N/A	Average over full height of column
Moment Frame			
Typical Moment Frame Columns	650 lbs/cy		Average over full height of column
Typical Moment Frame Beams	450 lbs/cy		

Element/Type	Reinforcement	PT	Comments
Core Walls			
Core walls only	450 lbs/cy	N/A	See Note 1
Miscellaneous Steel			
Roof framing, canopies, rooftop screen walls, miscellaneous ornamentation	12 psf	N/A	Refer to architectural for locations.

Notes:

1. Requires 120 feet of core wall in the north-south and east-west directions (total 240 feet of wall). Assumes 24" thick walls.
2. Assume 10" slab thickness. Mild reinforcing includes trim and support bars but not stud rails.



200 Occidental
Seattle, WA

**Description of Mechanical,
Plumbing, Fire Protection
and Electrical Systems**

Prepared for:

MITHÜN

ARCHITECTS • DESIGNERS • PLANNERS

Pier 56, 1201 Alaskan Way
Suite 200
Seattle, WA 98101

Prepared by

Flack + Kurtz Inc.
1417 Fourth Ave, Suite 400
Seattle, WA 98101

August 31, 2005

TABLE OF CONTENTS

ARTICLE	PAGE
I. HEATING, VENTILATING, AND AIR CONDITIONING.....	1
II. PLUMBING/FIRE PROTECTION.....	21
III. ELECTRICAL.....	30

I. HEATING, VENTILATING, AND AIR CONDITIONING

A. GENERAL

1. Mechanical systems will be designed in accordance with all applicable Codes, Standards and Authorities having jurisdiction, Underwriters Laboratories and in accordance with current engineering practices, including, but not limited to:
 - a. 2003 International Building Code including Washington State and City of Seattle Amendments
 - b. 2003 International Mechanical Code and City of Seattle Amendments
 - c. 2003 Uniform Plumbing Code and City of Seattle Amendments
 - d. National Fire Protection Association and Local Amendments
 - e. 2003 Washington State Energy Code and City of Seattle Amendments
 - f. 2003 Washington State Ventilation & Indoor Air Quality Code

B. DESIGN CRITERIA

1. Outdoor Design Conditions
 - a. Summer:
 - (1) 83°F Dry Bulb, (ASHRAE 0.5%)
 - (2) 65°F Wet Bulb (ASHRAE 0.5%)
 - b. Winter:
 - (1) 20°F Dry Bulb (ASHRAE 98%)
2. Indoor Design Conditions
 - a. Condos/Amenity Spaces:
 - (1) 78°F Cooling (no maximum in heating only option)
 - (2) 70°F Heating
 - (3) No humidity control

- b. Back-of-House/Elevator Machine Rooms:
 - (1) 78°F Cooling
 - (2) 65°F Heating
 - (3) No humidity control
- c. Retail:
 - (1) 76°F Cooling
 - (2) 70°F Heating
 - (3) No humidity control
- d. Street Car Maintenance Facility:
 - (1) 76°F Cooling Offices only, no cooling for shop area
 - (2) 70°F Heating Offices only, 65°F for shop area
 - (3) No humidity control

3. Ventilation Criteria

- a. Outside Air (except as noted below): 20 cfm/person (occupancy rates will be based on ASHRAE Std 62 criteria)
- b. Main Lobby: 0.25 cfm/ft²
- c. Public Toilets: 2 cfm/ft² (exhaust)
- d. Condo Toilet and Laundry Rooms: 5 air changes/hour
- e. Condo Corridors: 2 air changes/hour
- f. Street Car Shop Area: 1.5 cfm/sf general exhaust

4. Noise Criteria - Provide equipment, air distribution systems and air devices not to exceed the following NC (Noise Criteria) or RC (Room Criteria) levels (this criteria will need to be confirmed with the project acoustical consultant in the design development phase):

Space	Condos, Offices & Retail	Back of House, Street Car Shop
Maximum NC or RC Level (Hertz)	NC / RC 35 (db)	NC / RC 40 (db)
31.5	-- / 60	-- / 65

63	60 / 55	64 / 60
125	53 / 50	57 / 55
250	46 / 45	51 / 50
500	40 / 40	45 / 45
1000	36 / 35	41 / 40
2000	34 / 30	39 / 35
4000	33 / 25	38 / 30
8000	32 / -	37 / -

These NC values will need to be confirmed by an acoustical consultant in the next phase of design.

5. Internal Load Densities for Cooling Load Design

Type of Space	Lighting Watts/ft ²	Receptacle Load Watts/ft ²	Occupancy ft ² /person
Retail	6	Included in lighting load	75
Lobby and Corridors	2.5	N/A	500
Street Car Offices	1.0	2.0	100
Condos	750 watts	Included in lighting load	- 2 people per 1 bedroom - 4 people per 2 bedroom - 5 people per 3 bedroom

6. Building Envelope Assumptions for Cooling and Heating Design

a. Glazing: Low-e, insulated windows (Viracon VE 1-2M)

- (1) U-value: 0.26
- (2) Solar Heat Gain Coefficient: less than 0.38

b. Exterior Walls:

- (1) Spandrel glazing with R-21 insulation
- (2) Roofs: R-30 insulation
- (3) Exposed Floors: R-30 insulation

C. CONDOMINIUMS

For the condominium units, there is a key decision that is required prior to the completion of the schematic design phase with regards to the building envelope

design and if cooling will be provided. If the envelope is designed to provide the maximum amount of glazing for views and has no external shading then a mechanical cooling system is recommended in order to prevent the condos (especially the west facing units) from overheating. If, on the other hand, the building façade is designed to prevent solar heat gain with high performance glazing, external shading, high building mass, high R-value walls/roofs, and a fan assisted natural ventilation system, there is the possibility of specifying a heating only system, provided GBSRE is comfortable with projected maximum space temperatures and ventilation methods.

1. Cooling Option – If cooling is required for the condominiums, the following systems will be installed to meet this requirement and obtain high efficiency ratings in order to assist in achieving the LEED® Gold certification. A preliminary estimate based on 289,000 gsf of floor area is that we will require approximately 525 Tons of cooling.
 - a. Ground Loop Heat Exchanger - Ground loop (or geothermal) systems exchange energy with the earth. At depths below 6 feet, the earth is typically a relatively constant temperature compared with the surrounding air. This makes it an ideal medium to either reject heat from the building in a cooling cycle, or draw energy from the earth to heat the building. Geothermal systems can be configured in an open or closed loop.
 - (1) Open Loop – A well is drilled to a depth where the water capacity (1,100 GPM estimated requirement), temperature and quality are appropriate for this application.

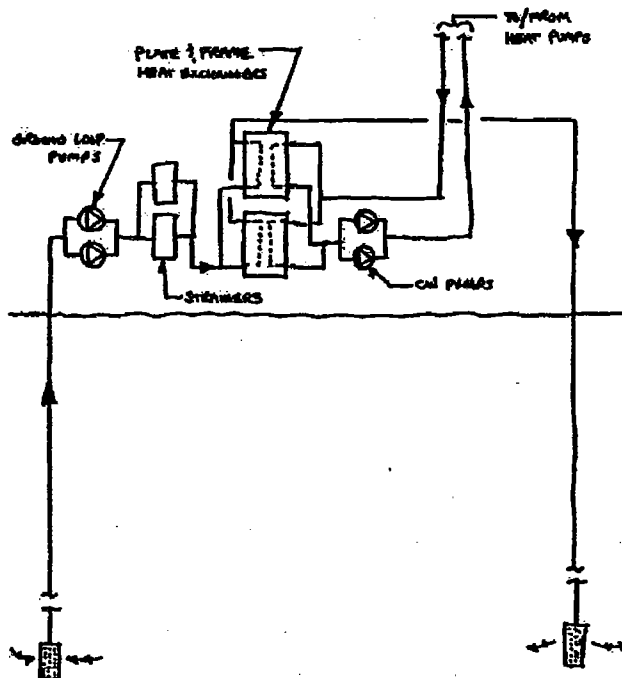

Open Ground Loop Schematic

Heating, Ventilating
and Air Conditioning

The water is drawn up and run through a centrifugal particulate separator and a plate and frame heat exchanger before being re-injected back into the ground through a separate well spaced far enough apart to prevent short circuiting. On the other side of the heat exchanger, a closed loop condenser water system would circulate water to the heat pumps. Brackish water is expected. Therefore, we anticipate using no-corrosive piping materials and titanium plate and frame heat exchangers.

- (2) Closed Loop - From the building, supply and return pipes would run underground to vertical bores. At this point the pipes would be connected to 1" diameter polyethylene tubing. This 1" polyethylene tubing is the primary heat exchange medium. Each vertical bore would be approximately 300 feet deep and have a capacity of 2 to 3 tons. Therefore, we would require approximately 175 bore holes to meet the 525 Ton estimated capacity. The bore holes are required to be separated by a minimum of 15'-0". Based on the site area will only be able to accommodate 100 to 120 bore holes, which falls short of our capacity requirements.

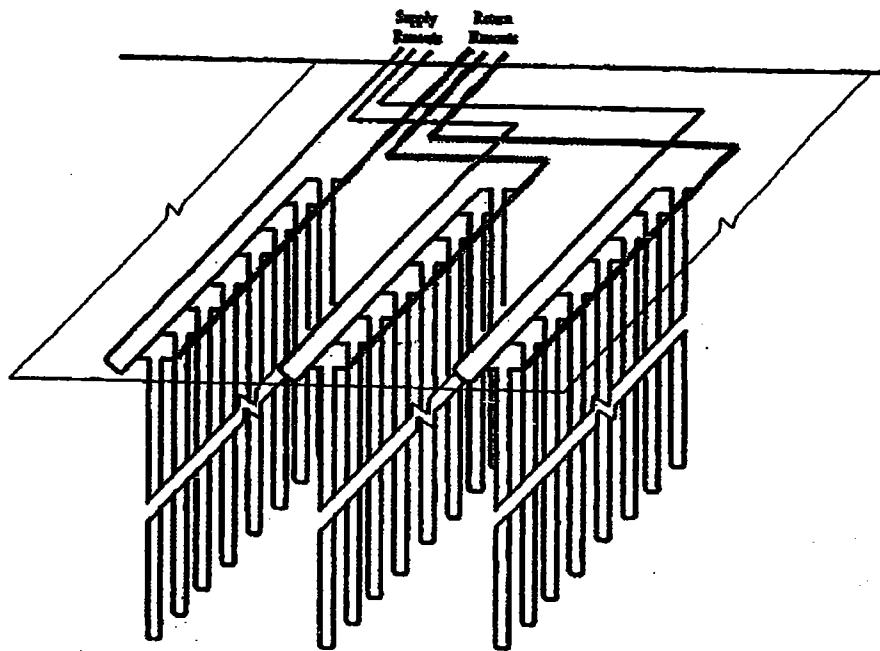

Sample Vertical Heat Exchanger

- b. Vertical Stack Water Source Heat Pumps - One vertical high rise stack type pre-piped heat pump unit (ClimateMaster VHS Series, or equal) will be provided for each condominium unit. Two heat pumps will be provided for corner units. There are approximately

24 heat pumps per floor. Most heat pump units will have some supply ductwork (assume 6'-0" average per unit). The heat pumps will be controlled by remote (assume an average of 15'-0" separation) programmable electronic thermostat with digital readout.

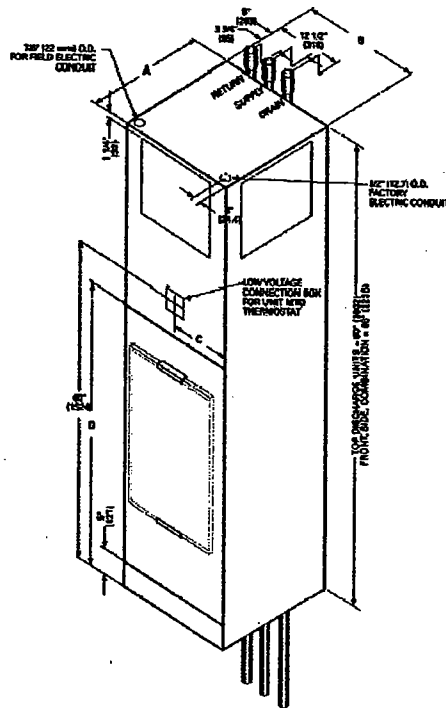

Vertical Stack Heat Pump

2. Heating Only Option – This alternative relies on an effective envelope that is capable of preventing solar heat gain through the use of external shading (most likely required for the south and west facades only), high performance glazing, , high R-value walls/roof and high mass in addition to fan assisted natural ventilation to flush the apartments at night in the summer when outside air temperatures typically drop below 75°F.
 - a. Heat Sources
 - (1) Gas Fired Boiler - Heating would be provided by hot water from two 2,200 MBH output, 95% high efficiency gas fired condensing boilers located on the roof in an enclosed boiler room. Two pumps (150 GPM each) with VFD's, will circulate heating hot water throughout the building.
 - (2) Steam – A high pressure steam line from Main Street will enter the building, connect to a pressure reducing station and then connect to two 2,200 MBH shell & tube heat exchangers. The building heating hot water system will

connect to the heat exchangers with two 150 GPM pumps used to circulate the water throughout the building.

b. Heat Delivery

- (1) Radiators – This option utilizes Runtal (or equal) baseboard hydronic radiators to deliver heat to the condos. These units can be controlled by a wall thermostat and control valve, or by a combined thermostatic control valve.

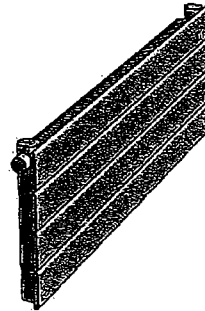

Runtal Model RF Wall Radiator

- (2) Radiant Floor – PEX tubing is embedded in the structural slab. As a preliminary estimate we can assume a 10" tube spacing within a 15'-0" perimeter zone. Each condo will have an header located in an interior wall cavity with an access door. From a construction standpoint, the PEX tubing would be attached to the wire mesh off site, delivered as needed and installed in sequence to avoid additional construction time during the slab pours.

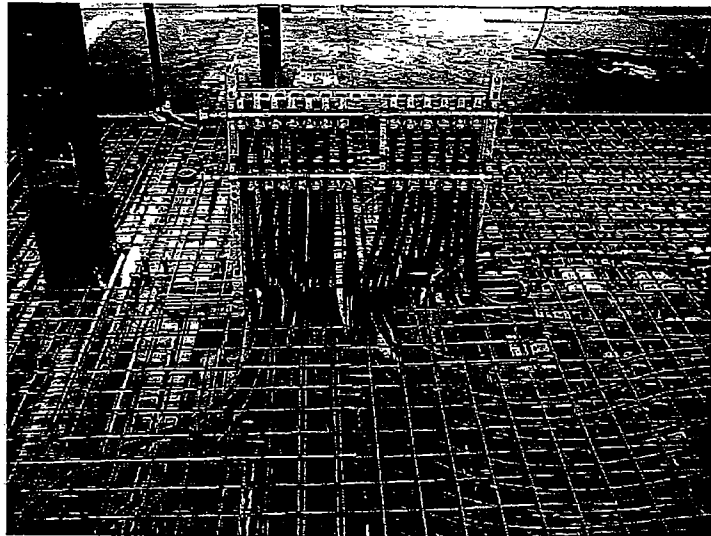

Radiant Floor Header and PEX Tubing

c. Night Flush for Cooling

Even with a high performance envelope system designed to prevent solar heat gain, outside air temperatures can reach into the high 80's and low 90's quite often in Seattle during the summer and early fall. However, Seattle does benefit from proximity to the Puget Sound with night time temperatures usually falling below 75°F (see weather data below for the number of hours in a typical year per temperature range between the hours of 8 PM and 6 AM). Without mechanical cooling it will be critical to ventilate the condos effectively in the evening in order to allow tenants to sleep comfortably.

Seattle TMY Weather Data
8 PM to 6 AM, Entire Year

Temperature		Total Hrs	Coincident Wind Speed (mph)
Mid-pts	DB (F)		
75	74 to 76	4	9
73	72 to 74	12	9
71	70 to 72	17	10
69	68 to 70	27	9
67	66 to 68	50	8
65	64 to 66	67	9
63	62 to 64	103	8
61	60 to 62	174	8
59	58 to 60	125	8
57	56 to 58	307	8
55	54 to 56	410	7
53	52 to 54	334	8
51	50 to 52	264	8
49	48 to 50	252	8
47	46 to 48	293	9
45	44 to 46	314	9
43	42 to 44	277	9
41	40 to 42	133	10
39	38 to 40	295	8
37	36 to 38	297	8
35	34 to 36	107	7
33	32 to 34	76	6
31	30 to 32	50	7
29	28 to 30	18	6
27	26 to 28	5	5
25	24 to 26	4	7

- (1) Atrium – The atrium option provides the best opportunity to utilize this central open space for fan assisted natural ventilation. The strategy requires propeller type relief air fans located at the top of the atrium, which will maintain a negative pressure in the atrium when ventilation is required and also operate in a smoke control mode to exhaust the atrium. At each condo there will be a fire/smoke damper to maintain the fire separation from the atrium and also allow the tenant to open or close the damper as need to help induce airflow through their condo unit.

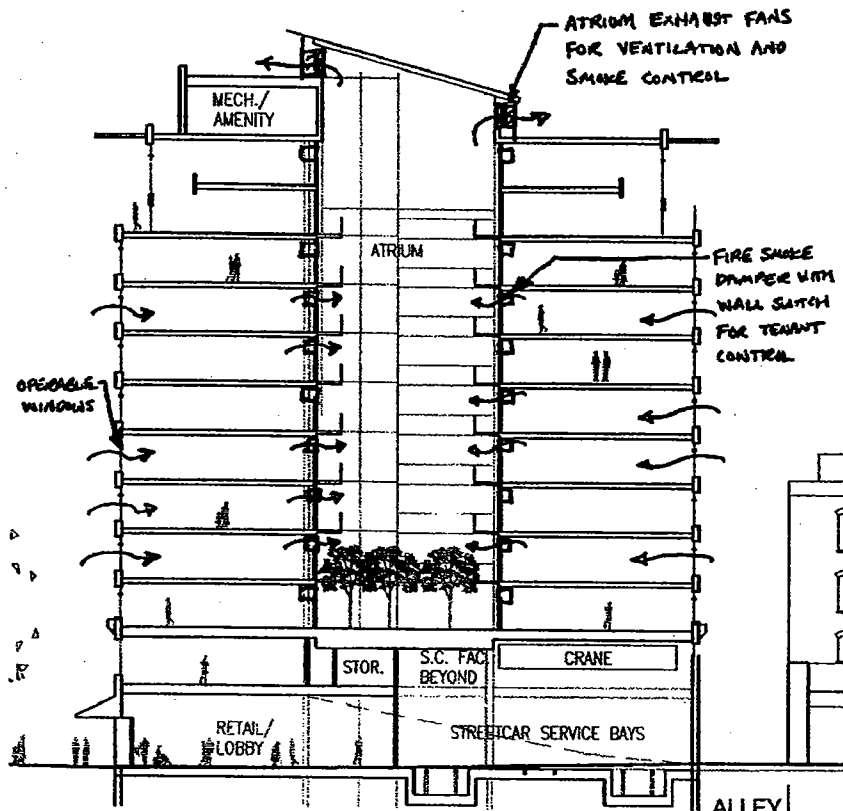

Atrium Fan Assisted Natural Ventilation

- (2) Increased General Exhaust – Without the atrium, the same strategy can still be achieved. In lieu of a common central atrium to induce airflow, the general exhaust shafts for the kitchen hoods and bathroom exhaust can be upsized to provide more exhaust for the condo unit in ventilation mode. However, the shaft areas would need to increase significantly (from 5 SF to at least 10 SF per condo), which reduces leasable area. In each condo there will be a relief air grille with an automatic damper controlled by a wall switch for the tenant to open, or close, as necessary.

3. Condo Corridor Outside Air Ventilation and Air Distribution

- a. Ventilation for the corridors shall be provided by a 100% outside air constant volume rooftop heat pump unit with heat recovery and gas heating sections. Two supply shafts will be provided in the core plan next to the stairwells. Each supply point is provided with a fire/smoke damper and supply air grille with integral opposed blade balancing damper.

Return/exhaust air for the corridors is provided via a central shaft located inside the core near the elevator shafts. Each floor return/exhaust opening will be provided with a fire/smoke damper

and a supply or return air grille. A rooftop exhaust fan with a heat recovery coil will be provided at the roof. This system will also be used for corridor smoke control purposes

4. General Condo Exhaust and Heat Recovery Make-Up Air Systems

- b. Each condo bathroom will be ventilated through a ceiling mounted exhaust fan controlled by a wall switch. The exhaust fan is ducted to a central vertical exhaust shaft along with the kitchen hood exhaust. These exhaust risers shall be collected on the roof and routed to two groups of central exhaust fans with heat recovery coils and variable frequency drives (VFD's). Connections to these shafts shall have 22" sheet metal sub ducts at each floor connection. The central exhaust fans shall run continuously and be on emergency power.

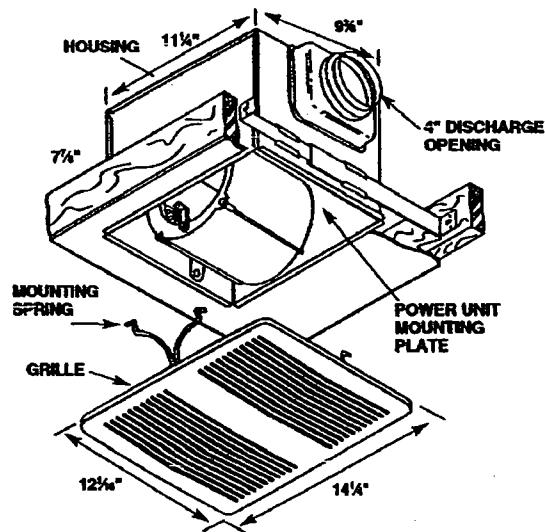

Bathroom Forced Air Return Terminal (FART) Fan

- c. Each condo kitchen hood will be connected to the same central exhaust system as the bathroom exhaust. The kitchen hood exhaust fan will operate using a switch located integral with the hood.
- d. The variable speed central exhaust fans are sized for 50% diversity (i.e. at any one time only 50% of the local toilet exhaust, or kitchen hood exhaust fans will be running). There will be 4 centrifugal roof exhaust fans sized for approximately 14,000 CFM each. The central exhaust fans will be controlled by a pressure sensor in the duct riser to ensure the exhaust shaft remains at a set negative pressure relative to the condo units.
- e. Make-Up air for the exhaust system will be provided by two rooftop air conditioning units (3,000 CFM each) with heat recovery

coils. There are two main objectives. The first is to make-up the air being removed from the condos by the central exhaust system during normal operation so the amount of infiltration through the façade is reduced. The second objective is to recover as much energy as possible for the air being exhausted.

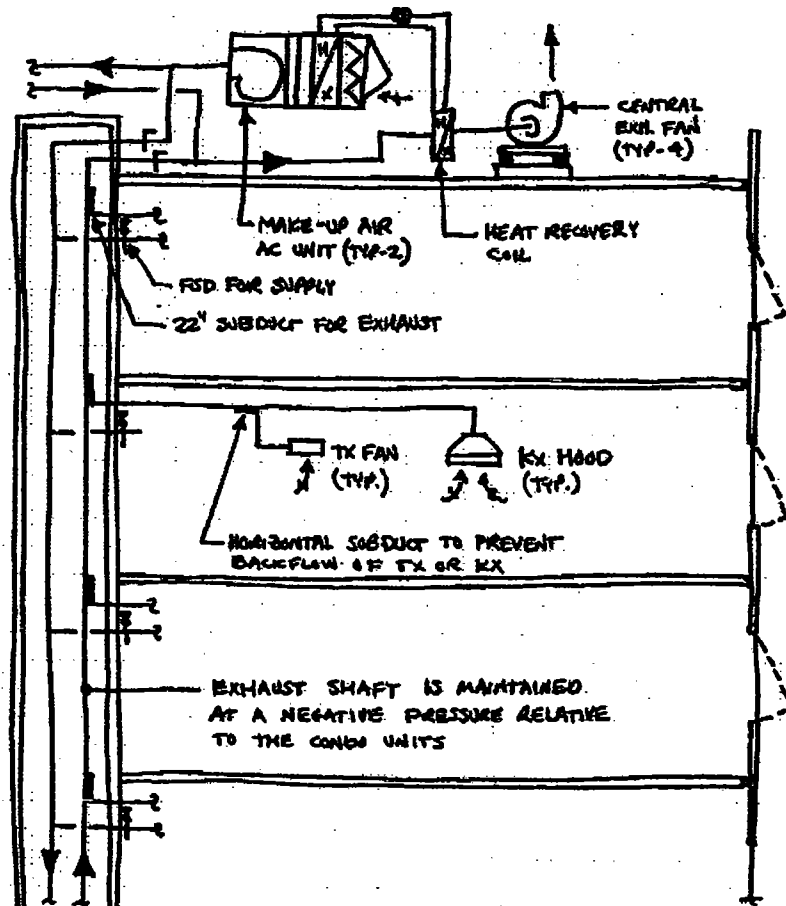

General Exhaust, Make-Up Air and Heat Recovery Schematic

5. Condo Dryer Exhaust System

- a. Each clothes dryer exhaust will be connected to a central exhaust riser through a 22-inch sub-duct. All dryer exhaust risers shall be routed up to the roof and exhausted by dedicated fans. Fans shall be variable speed and controlled by a pressure sensor in the duct riser. Each fan shall be sized for 50% diversity in the shaft. Preliminary estimates would require 20 roof exhaust fans (750 CFM each) with VFD's for volume control to ensure the shaft is always maintained at a negative pressure relative to the condo units.
- b. Lint collection points, and clean out access doors, will be provided at the bottom of each duct riser. The cleanouts will be accessed

through the condominium units. Exhaust fans shall run continuously and be on emergency power.

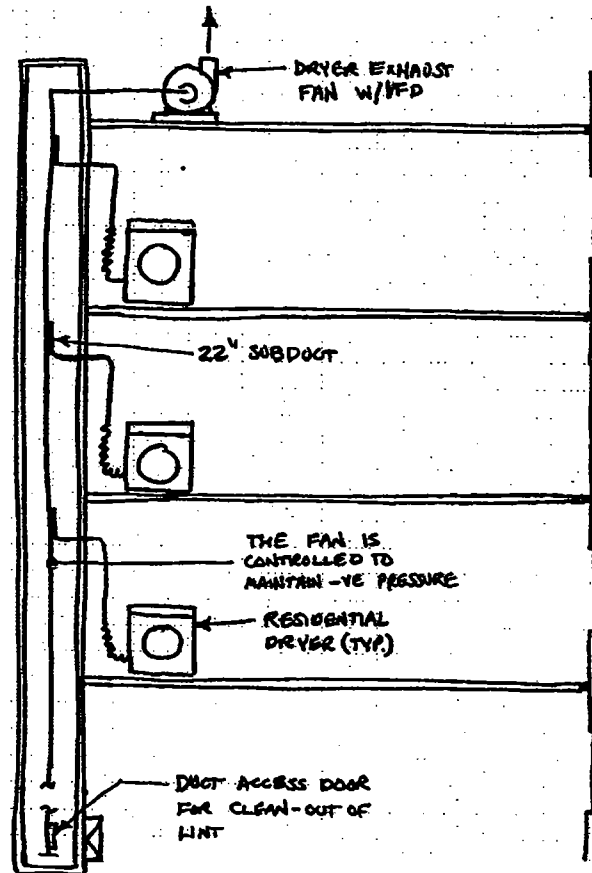

Dryer Exhaust Riser

6. Condominium Ventilation

- a. Operable windows have been specified to provide ventilation to each occupied room as required by code. In order to conserve energy a make-up air system with heat recovery will also be provided to supply 100% outside air for the condominiums.

D. MAIN LOBBY VENTILATION

- 1. The main lobby will be provided with a packaged water-cooled horizontal heat pump located in the ceiling plenum. Outside air for minimum outside air and economizer is provided through a louver at the façade. Dampers modulate to permit minimum ventilation levels or up to 100% outside air. Return/exhaust air will be provided through dampers and relief air louvers located at the building exterior and will operate to maintain proper building pressure and economizer operation.

E. STREET CAR MAINTENANCE SHOP SYSTEMS

1. Yard – The yard area is intended to be an indoor/outdoor space with open gates and fencing on the east and south faces. Therefore, no ventilation or heating will be provided.
2. Shop Area
 - a. Heating – A minimum space temperature of 65°F will be maintained using gas fired radiant heaters, or unit heaters with integral thermostats.
 - b. Exhaust – Several exhaust systems will be required to ventilate the shop area and are outlined below.
 - (1) General – A general exhaust system will provide a minimum of 4 air changes per hour (16,000 CFM) exhaust in the shop area. Make-up air will be provided through intake openings above the folding doors at the south wall of the shop area.
 - (2) Dust Collection – Devices requiring dust collection will be connected to a dust collector such as an AerPro Model SB-1500.

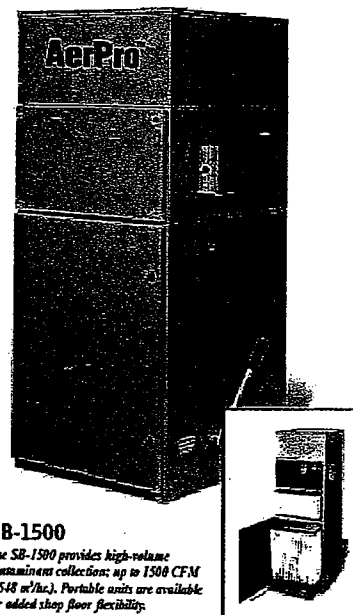

SB-1500
*The SB-1500 provides high-volume
contaminant collection; up to 1500 CFM
(2548 m³/hr.). Portable units are available
for added shop floor flexibility.*

Dust Collector

The air is filtered to remove the dust and recirculated into the room. This unit will typically be stationary and hard

pipled to the equipment requiring dust collection. However, it can also be portable if required.

- (3) Welding – As described by King County Metro, welding takes place at various places scattered throughout the shop area. In order to accommodate this scenario, we recommend providing a portable welding fume exhaust system such as an OsKar portable fume collector.



Roll-Out Portable Fume Collector

- (4) Pits – Each pit area will be provided with exhaust connected to the general exhaust system at a rate of 6 air changes per hour. The inlets will be located 6" above the lowest level in the pit.
 - (5) Paint Booth – The paint booth will be connected to an exhaust fan (estimated 1,500 CFM) located on the roof and a switch on the booth will activate the fan as required.
3. Offices – The office spaces on the mezzanine level will be provided with cooling, heating using horizontal water source heat pumps (two @ 3 tons each). Louvers at the exterior wall will provide outside air intake and the air will be relieved into the shop area through a counterweighted backdraft damper.

F. GARAGE VENTILATION

1. All-Up Scheme – Make-up air will be provide through the ramp and louvers and grates at the perimeter.
2. All-Down Scheme – Make-up air will be provided through the ramp and supply air shafts located at the south and north ends of the building. At each shaft a propeller type fan and counter balanced backdraft damper will provide outside air supply at each level.
3. In either scheme, each parking level is connected to the central exhaust duct shaft somewhere in the middle of the building near the elevator core. The exhaust air is collected at each parking level through intake grilles and balancing dampers and routed up to a central exhaust fan (150,000 CFM) on the roof. This system swill also be used in smoke control mode to exhaust the parking levels.

4. Carbon monoxide detection and control system will be provided to cycle garage supply and exhaust fans.

G. TRANSFORMER ROOM VENTILATION SYSTEM

1. Transformer room supply and/or exhaust fans will provide sufficient ventilation for the transformers, based on SCL criteria.

H. FIRE PUMP AND FUEL OIL ROOM VENTILATION

1. The fire pump rooms will be located at, or below, grade. They will be provided with make-up air and exhausted directly to the exterior.
2. The fuel oil room will be located at, or below, grade and will be exhausted directly to the exterior a minimum of 10 feet above grade.

I. ELEVATOR MACHINE ROOMS

1. The elevator machine rooms will be air-conditioned using direct expansion cooling systems located outside, but adjacent to the rooms.

J. SUPPLEMENTAL AIR CONDITIONING UNITS

1. Direct expansion indoor water-cooled systems for 24-hour air conditioning of electrical rooms, computer rooms, telephone equipment room and other rooms as required will be provided.

K. GROUND FLOOR RETAIL HVAC

1. Condenser water supply and return valved and capped for tenant use. Outside air for ventilation will be located in soffits, overhangs or louvers at the ground floor level.
2. Kitchen grease hood exhaust for the restaurant/bar space will be routed to the roof in a rated enclosure with access points at each level for inspection/cleaning per NFPA. The restaurant/bar tenant shall be required to install the kitchen hood, roof exhaust fan and connecting ducts.

L. SMOKE MANAGEMENT & FIRE/LIFE SAFETY SYSTEM

1. The condominiums shall be provided with smoke management as required by the local Building Code using the pressure differential method. The floor smoke management system will utilize the corridor exhaust/smoke exhaust fan systems to prevent migration of smoke from the smoke zone. Each floor's corridor is considered a smoke zone. Operation of the smoke control system is controlled automatically by the fire alarm system. Condo units are considered as passive zones.
2. Stair and vestibule pressurization systems are also provided.

3. The parking exhaust fans are utilized for smoke control from the parking garage.
4. Elevator machine rooms are pressurized to prevent smoke entering the machine room from an adjacent fire.
5. All equipment over 1500 cfm air capacity shall have smoke detectors, and will be shut down in an alarm.

M. DUCTWORK

1. Requirements:
 - a. Type: Low and medium velocity galvanized sheet metal constructed in compliance with SMACNA Standards.
 - b. Joints: Seal supply and return ductwork joints and seams with hard-cast.
 - c. Runouts to Diffusers: May be medium pressure rated, externally insulated, spiral wound, flexible duct with a maximum length of 8 feet.
 - d. Sizing: To minimize airborne noise and ensure space criteria are met, size ductwork for maximum duct velocity as follows:
 - (1) 2,000 fpm: Main supply ducts on risers.
 - (2) 1,500 fpm: Branch ducts and return/exhaust systems
 - (3) 800 fpm: Ducts connected to heat pumps or serving room terminal air devices.
2. Acoustic Lining: Acoustic lining will be provided as recommended by acoustical consultant, but generally placed in first 15 feet of ductwork downstream of noise source. Acoustic lining must be faced with mylar or other impervious coating or a fiber-free product may be used. Fiberglass may not be exposed in the air stream. In medium velocity ducts (i.e. at the discharge from AC units) the acoustic lining will extend for 20' and will include a perforated metal inner liner.

N. PUMPS FOR HEATING AND COOLING SYSTEMS

1. Type: Split Coupled Vertical In-line (Armstrong Series 4300 or equal).
2. Sizing: Selected for maximum efficiency, minimum 10% larger than calculated brake horsepower with flows to match equipment.
3. Condenser Water: Two variable volume pumps with 'premium' high-efficiency motors rated for inverter duty, for general condenser water distribution.

4. Heating Water: Two variable volume pumps with variable frequency drives and premium efficiency motors rated for inverter duty. Locate pressure sensors in most remote areas of the building.
5. Mounting: Install pumps on 4-inch high concrete housekeeping pads. Provide braided stainless steel flexible pipe connectors at suction and discharge of each pump to isolate the piping system and spring isolators for piping hangers and supports within 100 feet of rotating equipment.

O. PIPING SYSTEMS

1. Provide a reverse return piping loop for the floor distribution to the vertical stack heat pump risers. No increase in piping will be required.
2. Metering of the condenser water is provided at each condo unit and retail unit.
3. Water Treatment: Water treatment chemical feed equipment and chemicals for closed circulating water systems will be provided.
 - a. Closed circuit condenser and heating water systems will be provided with automatic shot feeder system.
4. Pipe Material:
 - a. HVAC Wet Systems: Either Schedule 40 black steel (welded, screwed or grooved), Type "L" copper.
 - b. Di-Electric Unions: Must be provided for connections of different materials.
 - c. Solder for Copper: 95/5 tin silver solder.
 - d. Refrigerant Piping: Type "L" copper, 45% silver solder.
5. Pipe Supports: Clevis or Uni-strut trapeze hangers with spacing for steel or copper piping system supports based on pipe diameter, plus provide supports on both sides of changes in direction and at both sides of valves and fittings. Provide seismic bracing.
 - a. 2 inches and smaller: 6 feet maximum
 - b. 2 inches to less than 6 inches: 10 feet maximum
 - c. 6 inches and larger: 15 feet maximum
 - d. Provide copper coated, steel riser clamps for use with copper pipe at floor penetrations.
 - e. Hanger shields – Provide at each hanger for insulated piping.

- f. Spring Isolation – All piping on the roof of the mid rise building is spring isolated.
- 6. Pipe Insulation: Insulation for piping as required by Washington State Energy Code.
- 7. Valves: The piping distribution system will have shut off valves located to permit repairs without shutting down more than one piping riser at a time.
 - a. Shut-Off Valves: Shut-off valves will be provided for each piece of piped equipment to permit replacement, accessible service and repair without disturbing other equipment that is not dependent on operation of the equipment to be serviced. Full-port ball valves or butterfly valves will be provided for the following applications:
 - (1) In condenser water supply and return piping to all equipment
 - (2) On both sides of control valves in condenser water and heating hot water systems
 - (3) At the start of all risers in condenser water and heating hot water supply and return piping.
 - (4) At major branch take-offs for isolation of systems
 - b. Automatic/Pressure Independent Balancing (Flow Control) Valves:
 - (1) Type: With memory stop and measuring ports to calibrate pressure drop and water flow
 - (2) Location: At return pipe and riser of each piece of equipment and at other locations as shown on the plans.
 - c. Control Valves: Provide types in the following locations:
 - (1) 2-way control valves on heat pump units in condenser water supply
 - (2) Size 2-way control valves to handle system differential pressure
- 8. Strainers: Strainers with drain valve will be provided at each pump, control valve and at the base of condenser water and heating hot water supply risers and at each heat pump unit coil for drain down.

P. BUILDING MANAGEMENT SYSTEM (BMS)

- 1. Requirements: Provide a BMS computer based system capable of controlling central plant equipment, fans, HVAC units, excluding individual

Condo heat pump units and designed for expandability by using plug-in modules.

- a. Locate central BMS components in the building Engineering offices.
- b. Provide local stand-alone field control modules in each major mechanical room.
- c. The BMS Subcontractor is responsible for all power wiring from designated circuits identified in the electrical panel schedules.

2. System Overview: Provide a Direct Digital Control (DDC) system with full control of mechanical equipment, excluding Condo unit heat pumps. Provide BMS to monitor environmental data and control the function of the following equipment installed in the facility:

- a. Water treatment
- b. Boilers
- c. Plate and frame heat exchangers (if required)
- d. Pumps
- e. Air conditioning units and non Condo heat pump units
- f. Ventilation air conditioning units
- g. Exhaust fans
- h. Lighting system (interior and exterior) time clocks
- i. Garage fans
- j. Ventilation systems
- k. Domestic hot water systems
- l. Sump and sewage pump alarms
- m. Fuel oil system
- n. Security system interface
- o. Fire alarm system interface
- p. Emergency generator
- q. Energy meters

r. Other designated functions/systems

3. The BMS system will be set up to easily trend logs and sequentially download them for long-term data storage.
4. Provide complete system of electronic PID control technology to automatically maintain and regulate environmental conditions.
5. Use system architecture with intelligent field distributed control modules to communicate in both LAN/WAN and WEB configuration communications.

II. PLUMBING/FIRE PROTECTION

A. GENERAL

1. Mechanical systems will be designed in accordance with all applicable Codes, Standards and Authorities having jurisdiction, Underwriters Laboratories and in accordance with current engineering practices, including, but not limited to:
 - a. International Building Code – 2003 Edition with City of Seattle Amendments
 - b. Uniform Plumbing Code – 1997 Edition with City of Seattle and King County Amendments
 - c. International Fire Code – 2003 Edition with City of Seattle Amendments
 - d. Washington State Energy Code – 2003 Edition with City of Seattle Amendments
 - e. National Fire Protection Association Standard 13, 2002 Edition
 - f. National Fire Protection Association Standard 14, 2000 Edition
 - g. National Fire Protection Association Standard 20, 1999 Edition
 - h. National Fire Protection Association Standard 72, 1999 Edition
 - i. Applicable Factory Mutual Insurance Company Data Sheets
 - j. FM GLOBAL Data Sheet 2-8 “Earthquake Protection for Water-Based Fire Protection Systems”
 - k. FM GLOBAL Data Sheet 2-8N “Installation of Sprinklers (NFPA)”
 - l. Local Codes, Code Amendments and Requirements

B. STORM WATER DRAINAGE SYSTEMS

1. Building roofs and terraces drains will be drained at low points by gravity through storm leaders. The building storm drains will extend to 5 feet outside building.
2. As an added feature of the storm drainage system, rainwater will be collected, stored, and filtered for reuse in graywater consuming fixtures, such as urinals and water closets. This feature will both reduce the quantity of rainwater contributed to the Seattle municipal stormwater system and reduce the volume of municipal water used by the building.

3. Storm water will be collected in a central stormwater detention vault meeting the requirements of the City of Seattle DPD. The detention vault will be located in the garage level of the building. Stormwater will be released at a reduced rate, through the use of an orifice assembly, as it is passed to the municipal storm system. Provisions to reclaim stormwater will be made at the detention vault to allow reuse of the stormwater.
4. Where roof drains are provided, overflow drains shall be installed and connected to the common storm line in the vertical per local code amendments. The system will be designed to drain by gravity. The storm drainage system will be designed for 100-year 1-hour duration storm event equaling 1.0 inches per hour.
5. Vent shafts, light wells, or similar areas having rainwater drain shall discharge directly into a building drain or building sewer.
6. Clear water drains below the Parking Level will be run by gravity to duplex sump pumps and pumped into gravity building drainage system.

C. SANITARY DRAINAGE AND VENT SYSTEMS

1. Plumbing fixtures will be drained by gravity through soil, waste and vent stacks, building drains and building sewers, to 5 feet outside building.
2. Waste stacks will be provided for the drainage connections to the washer wall boxes, kitchen sinks, bathtubs, and the other suds producing fixtures that are defined by the plumbing code. Fixtures shall be connected to these waste risers outside of the suds producing pressure zones, in accordance with code.
3. Sanitary and vent stacks shall be routed through the building floors. Where runs do not offset horizontally, yoke vents shall be provided at every fifth floor, counting down from the upper-most fixture drain. The yoke vent shall be not less than either the drainage or the vent stack, which ever is smaller.
4. Plumbing fixtures below building drainage system will be drained by gravity to (duplex) sewage ejectors and pumped into the gravity building drainage system.
5. Floor drains will be provided throughout the parking garage levels and collected at the bottom where a sand / oil trap will pretreat the garage wastes before connecting to the interior sanitary system.
6. Restaurant Tenant: Space:
 - a. A centralized grease interceptor will be provided for the restaurant tenant. The grease interceptor will be installed in a suitable location, where it can be readily serviced and cleaned. The grease interceptor will be fabricated of concrete and will consist of

a central compartment, with grease baffles, manhole covers, and sampling tubes to allow sampling of the grease effluent.

7. Street Car Shop:
 - a. A sand-oil interceptor will be used to pretreat waste-water that is collected from the street car shop area. Wastes from the shop area will be collected in trench drains and routed to the sand-oil interceptor. This system will be routed separately to the building site, where the connection will be continued on the civil engineers site drawings.

D. DOMESTIC WATER SUPPLY SYSTEMS

1. Metered service to building potable water system will be extended from water main 5 feet outside building. Water will be distributed through mains, risers, and branches to plumbing fixtures and equipment.
2. Protection against backflow shall be maintained with a double check type backflow prevention device. The backflow preventer will be installed inside the property line and will be available for inspection and testing.
3. System water pressure will be maintained by a constant speed variable volume triplex booster pump system. Pumps shall be constant speed vertical multi-stage diffuser type with stainless steel shafts. Pumps will be located in the basement of the building. The units system capacity and pressure requirements will be determined as the design progresses. The complete packaged pumping system, including pumps, motors, programmable control equipment and transducers, ASME tank(s), valves, fittings and manifolds must be UL listed. In addition to the UL listing for the complete system the control panel assembly must be separately listed under UL-508 Industrial Control Equipment. The booster system shall be factory assembled on a steel skid including pumps, motors, valves, stainless steel suction and discharge manifolds, and all interconnecting piping, wiring and controls. Provide isolation valves on the suction and discharge of each pump. The valves shall be ball valves. Provide two (2) ANSI grade A, panel mounted gauges for indicating system suction and discharge pressure.
4. Cold water system will be designed to maintain a maximum velocity of 6 feet per second (fps) at design flow conditions using flush tank fixture unit values for the condominium units. Sizing tables suitable for flush valve fixtures will be applied for systems serving the public spaces of the building. Hot water return system will be designed to a maximum velocity of 4 fps.
5. A pressure reducing valve station will be provided at pressure zones to limit pressure to 72 psig at fixtures and equipment. The station shall consist of 3-inch pilot operated pressure regulating valve, one 2-inch and one ¾-inch direct acting pressure regulating valves with full line size bypass valve, pressure gauge and isolation valves on each side of

pressure regulating valves. The direct acting pressure regulating valves shall include integral strainers. A minimum of 20 psi will be provided at the highest fixture in the pressure zone. Where the pressure balance shower valves are provided, a minimum pressure of 45 psi will be maintained at these fixtures to assure proper operation of the shower valves.

6. Parking levels will be supplied by municipal water pressure serving the hose bibs. Water pressure will be boosted for upper floor levels by pressure zones connected to the main high pressure express cold water mains.
7. Shock arrestors will be provided at top of risers, between the last two fixture on group toilet flush valve fixtures, on the outlet side of pressure regulator valves, inlet and outlet sides of reduced pressure zone type backflow preventers, and at the washer wall box supplies to control water hammer. Lifetime warranted piston type shock arrestors will be provided to minimize maintenance of shock absorbers. Shock arrestors will also be provided wherever quick closing valves or solenoid valves are used with any equipment.

E. DOMESTIC HOT WATER SYSTEMS

1. Condominium Units:
 - a. The building is divided pressure zones. Each pressure zone will serve approximately 6 floors of the building. This will maintain pressures within the zone in the range of 45 to 72 psi.
 - b. Potable hot water for the zones will be provided by high efficiency Aerco gas water heaters piped in parallel, located in a mechanical space within the building (preferably at the top level of the building). An express riser will be routed down the building, where a set of pressure reducing valves will be used to reduce the express riser pressure. The express riser will then continue to feed down to the pressure zones below. At the 1st floor ceiling, express hot water supply will change into a hot water return line; this will be the main hot water return line returning water to the roof level. The hot water return line will be connected to circulating pumps and then connected to cold water inlets at the water heaters.
 - c. A pressure reducing valve station will be provided at each of the pressure zones to limit pressure to 72 psig at fixtures and equipment. The station shall consist of 3-inch pilot operated pressure regulating valve, one 1½-inch and one ¾-inch direct acting pressure regulating valves with full line size bypass valve, pressure gauge and isolation valves on each side of pressure regulating valves. A minimum of 45 psi will be provided at the highest fixture (where pressure balance shower valves are used). Minimum pressure at the roof will be 30 psig. The direct acting

Plumbing/Fire Protection

pressure regulating valves shall include integral strainers. Hot water temperature will be maintained throughout the system by use of a circulating piping system incorporating circulator pumps. A return loop shall be provided for each pressure zone. A balancing valve, "Model CBV" by Armstrong, and check valve will be installed at each return line prior to connecting to return express riser and balanced to a flow rate of not less than 1 gpm for each return. A circulation pump will be provided on each return to complete system circulation to the domestic hot water storage tanks.

2. Retail Spaces:

- a. The retail spaces within the building will be provided with small, point of use water heaters located near their fixtures requiring potable hot water. These water heaters will typically be located above the ceilings or beneath the counter casework space near the fixtures that they serve.

3. Restaurant Space:

- a. The restaurant space will be furnished with two redundant, gas-fired domestic water heaters. The water heaters will be dedicated to the restaurant tenant only and will serve 140 degree water to all of the restaurant service areas. 120 degree water will be produced through the use of thermostatic mixing valves for handwash stations within the kitchen service areas. These water heaters will require a mechanical room within the kitchen space and clearance to allow servicing of the components.

4. Street Car Maintenance Shop:

- a. The street car shop will be furnished with a single, gas-fired domestic water heater. The water heaters will be dedicated to the street car service shop only and will serve water to all of the fixtures within the shop areas. 140 degree water will be stored in the water heater and 120 degree water will be produced through the use of thermostatic mixing valve. This water heater will require a mechanical room within the space and clearance to allow servicing of the components.

5. As an option, alternate methods of heating domestic hot water are being investigated. These options include the use of solar energy for heating potable water.

F. GAS SYSTEMS

1. Metered regulated medium pressure gas will be extended from the building meter and distributed through mains, risers and branches to all gas fired equipment.

2. Gas distribution will be fed up through the building in an express medium pressure gas riser. There will be an isolation valve at the base of the riser. All gas piping installed in walls shall be protected using steel striker plates in accordance with NFPA 54.
3. Provide flexible gas connector and shutoff for each gas appliance.
4. Gas pressure will be regulated to 7-inch water column and distributed at this pressure with a minimum pressure drop of 0.5 inches water column at most remote equipment connection.

G. FUEL OIL SYSTEM

1. A fuel oil system will be provided for the emergency generator. The system will include double contained supply and return piping, duplex transfer oil pumps, UL2085 compliant double wall "firesafe" above ground tank by Ace Tank Company or approved equal, remote fuel fill box and alarm panel, fuel monitoring panel and leak detection devices. Provide fuel filtration equipment and pumps equivalent to equipment by Earthsafe. The emergency generator will be approximately 250 kW, fuel oil consumption is 20 gph. We need to store fuel for 8-hour continuous use of emergency generator. Emergency generator will be in a location to be determined. The fuel oil storage tank should be located near the fill station.

H. STREET CAR SHOP COMPRESSED AIR SYSTEM

1. The street car shop will be served by a compressed air system that will be used to power small tools and equipment. A central air compressor will be located in a mechanical room and piping will be routed from the compressor to the various locations where equipment will be used. The compressor will be sized to provide 100 psi compressed air throughout the facility. Individual air drops with filter / oiler / regulators and quick connects will be provided at locations to be determined as the design of the project progresses.
2. Compressed air piping will be comprised of schedule 40 carbon steel piping with threaded malleable iron fittings. All threaded fittings will be joined with joint compound or through the use of Teflon tape.

I. STREET CAR SHOP LUBE OIL SYSTEM

1. The Street car shop will be served by a lube oil system that will be used to lubricate street car components and to change any lubrication fluids within the street cars. A central equipment room will enclose all of the lube oil containment tanks and the pneumatic pumps that will be used to convey the various lubrication fluids. Piping will be routed throughout the facility to the various locations where lube dispensers are required. The lube dispensers will be supported overhead with drop reels to allow fluids to be dispensed. The lube dispensers will include metering devices to measure the quantities of fluids dispensed. Distribution piping will be comprised of

seamless carbon steel tubing with either weld fittings or compression style fittings. Tubing shall be joined by welding or through the use of compression joints.

J. FIRE PROTECTION

1. An 8-inch water service to building will be extended from water main 5 feet outside building and connected to the building fire suppression system.
2. System operation shall be under pressure provided by automatic fire pumps located in the lower levels of the building. One electric fire pump and a jockey pump with transfer switch with interlock between transfer switches to prevent more than one fire pump from running at one time will be provided.
3. There will be low pressure fire department connections located outside the building, connected to the system with check valves.
4. Fire pumps shall be supplied by an on site water storage tank of 15,000 gallons. A dedicated building water service will also be provided to ensure a secondary supply.
5. System standpipes shall be a combination wet standpipe and automatic wet sprinkler standpipe with two 2-1/2 inch outlets for fire department use located in the intermediate landing of each stairway.
6. Double check valve assembly will be installed to protect the water system from contamination.
7. The building will be protected by a hydraulically calculated automatic wet sprinkler system. Each floor will be considered as a separate sprinkler zone and be fed with two separate risers, each with its own sprinkler control valve assembly consisting of a supervised valve, flow switch and drain valve.
8. All sprinkler systems shall be hydraulically calculated. In the event design criteria information from the project fire insurance underwriter is unavailable at the time of initial design, the following minimum criteria shall be used.
 - a. Light Hazard: Condominium floors shall be sized to deliver 0.10 gpm/sq. ft over an area of 1500 sq. ft. at the most hydraulically remote location.
 - b. Ordinary Hazard: Group 1: Parking, tenant service area, piping shall be sized to deliver 0.15 gpm/sq. ft. over 1500 sq. ft. at the most hydraulically remote location.
 - c. Ordinary Hazard: Group 2: Retail areas, truck dock, storage areas, shop areas, and mechanical rooms, piping shall be sized to

deliver 0.20 gpm/sq. ft. over an area of 1500 sq. ft. at the most hydraulically remote location.

- d. Extra Hazard: Group 1: Street Car Service Area, piping shall be sized to deliver 0.30 gpm/sq. ft. over an area of 2500 sq. ft. at the most hydraulically remote location.
9. The two 2-1/2 inch valved fire department connection will be provided in each stairway and at each level as required by the City of Seattle Fire Department. Pressure reducing type hose valves will be provided where pressures exceed 175 psi.
10. A 3-inch drain stack will be provided adjacent to each standpipe for sprinkler system drain down and testing hose valves.
11. Sprinkler heads will be fast response type, chrome finish with white escutcheon.

K. INSULATION

1. All piping, components, and equipment subject to sweating or heat loss will be insulated with appropriate thickness of fiberglass and fire retardant jacket.
2. Provide insulation for hot water and hot water circulation piping to fixture roughing-ins as required by the Washington State Energy Code, but not less than 1½-inch thick.
3. Provide insulation on domestic hot water storage tanks with insulation thickness not less than 3 inches using fiberglass insulation and aluminum jacket.
4. Storm and domestic cold water piping will be insulated for acoustics using a minimum of ¾-inch thick for ¾-inch and smaller piping, 1-inch thick for 1 through 2-inch piping, 1½-inch for 2½-inch and larger piping.
5. All valves installed in water piping systems shall be insulated with same thickness as line size of piping.

L. PLUMBING FIXTURES

1. Provide Kohler, American Standard, Toto or equivalent fixtures in Units. Fixtures will be provided with chrome-plated brass trim and individual stop valves.
2. Public water closets will be vitreous china siphon jet wall hung 1.6 gpf sensor operated flushometers type
3. Public urinals will be vitreous china, wall hung siphon jet, 1.0 gpf sensor operated flushometer type.

4. Public lavatories will be provided with 0.5 gpm flow restrictors using sensor-operated faucets.
5. Living units rooms shall be tank type, floor outlet, 1.6 gpf type.
6. Showers and bathtubs will include thermostatic mixing valves, with 2.5 gpm flow restrictors in showerhead.
7. Bathtubs will be fiberglass with acrylic finish and have non-skid bottoms.
8. Drinking fountains will have integral chiller units.
9. Living unit lavatories shall include undercounter oval vitreous china bowl and mixing valve style faucet.
10. Provide floor drains with trap primers in all Public Toilet rooms.

III. ELECTRICAL

A. CODES AND STANDARDS

1. 2003 International Building Code including Washington State and City of Seattle Amendments
2. Seattle Fire Marshal Requirements
3. 2002 National Electrical Code with City of Seattle Amendments
4. 2003 Washington State Nonresidential Energy Code
5. American National Standards Institute (ANSI)
6. Institute of Electrical and Electronics Engineers (IEEE)
7. Illuminating Engineering Society of North America (IES)
8. National Fire Protection Association (NFPA)
9. National Electrical Manufacturers Association (NEMA)
10. Underwriters Laboratories (UL)

B. SEATTLE CITY LIGHT (SCL) TRANSFORMER VAULT

1. The Owner is responsible for the construction of a network transformer vault to house the SCL service equipment. The vault will be located at basement level, along a perimeter wall, at a location near to SCLs preferred service entrance location. The transformer vault will be provided with adequate provisions for transformer ventilation and access in accordance with SCLs construction standards.
2. The AFC for the Building is estimated at 100,000 Amps symmetrical.

C. METERING ARRANGEMENTS

1. A separate utility will be provided for each service entering the building (refer to Section D for details).
2. The Condominium Units will be metered in the main switchboard. In addition the residential units will be separately metered with residential meter stacks located on every other floor. The primary feeder to each meter stack will also be metered to allow subtractive metering by SCL.

D. MAIN ELECTRICAL SERVICE

1. The main switchboard room will be located adjacent to the SCL transformer vault. Service will be supplied at 480Y/277V, 3-phase, 4-wire. The building will have 5 services as outlined below:
 - a. Condominium units: A separate main switchboard rated 1600A, 480Y/277V (with meter) will be provided to serve a main buss riser to feed transformers and meter stacks. The feeder buss will be tapped on with a 450A fused bus plug on every other floor to serve a 300kVA transformer that will sub feed meter stacks for up to 42 units.
 - b. House power: A separate main switchboard rated 500A, 480Y/277V (with meter) will be provided.
 - c. Retail: A separate retail meter center, rated 400A will be provided to serve retail tenants.
 - d. Fire pump: A new fire pump will be served via a 480Y/277V, 200A service. The main disconnect switch will be sized for locked rotor current. The service feeder is sized for the full load current.
 - e. Street Car Shop: A separate main switchboard rated 600A, 480Y/277V (with meter) will be provided.
2. Acceptable Manufacturers: Cutler Hammer, General Electric, Siemens or Square D/Groupe Schneider.

E. SECONDARY DISTRIBUTION

1. Tenant Floors: Electrical power will be distributed at 277/480V, 3-phase, 4-wire through an electrical riser closet. A 1600A bus riser will be provided to distribute 277/480V. Fused plug in units will be provided to tap power from the bus riser on every other floor and feed a 480-208Y/120V transformer rated at 300kVA. The transformer will feed a residential meter center. One residential meter center will be provided on every other floor and will serve the floors above and below.
2. Building house loads and emergency loads will feed from a conduit riser extending up the building. For corridor lighting and power, one 100A, 42 pole, 277/480V, 3-phase, 4-wire panel, a 30kVA transformer and 100A, 120/208V, 3-phase, 4-wire panel will be provided every fifth floor. For emergency power, one 60A, 42 pole, 277/480V, 3-phase, 4-wire panel, a 15kVA transformer and 50A, 120/208V, 3-phase, 4-wire panel will be provided every fifth floor and on the roof.
3. Street Car Shop: Electrical power will be distributed at 277/480V from a 600A feeder from the main switchboard room. The shop will be provided a location to house a 600A, 277/480V lighting and equipment panel, a

45kVA transformer and a 150A, 120/208V, 3 phase 4 wire panel board to serve the Street Car Shop loads.

4. Each major mechanical equipment room will be served from a dedicated distribution panelboard or motor control center for power supply to mechanical equipment. This panel will subfeed a 480-208Y/120V transformer and panel for convenience power loads.
5. Disconnect Switches: Heavy duty, horsepower rated, quick-make, quick-break, dead-front type. Self contained unit in a NEMA 1 enclosure (NEMA 3R where installed outdoors).
6. Panelboards: Corrosion resistant galvanized (zinc finished) sheet steel. Fronts shall be cold rolled steel, finish coated with ANSI 61 gray enamel over a rust inhibitor. Bus bars shall be copper or aluminum, full size neutral bus. Provide an equipment ground bus in each panelboard. Overcurrent protection devices shall be molded case circuit breakers for branch panelboards and fused switches for distribution panels.
7. Residential units shall be provided with a 100A MCB, 120/208V 1-phase, 3 wire residential load center.
8. Motor Control Centers: Wiring shall be NEMA Class I, Type 1B. Totally enclosed, dead front, freestanding assemblies, NEMA 1A, front accessible only. Bus bars shall be copper or aluminum. Provide a 33% minimum ground bus, extending along the full length of the motor control center. Starters shall be full voltage non-reversing (FVNR) type combination magnetic starters for motors of ½ HP to 60 HP. Provide reduced voltage, non-reversing, auto transformer type combination magnetic starters for motors 75 HP and larger.
9. Grounding: Provide a complete NEC grounding system. Feeders and branch circuits shall be provided with an insulated grounding conductor run with the circuit conductors. This grounding conductor shall be in addition to the ground path provided by the continuously grounded metallic raceway system that encloses the phase and neutral conductors.
10. Acceptable Manufacturers: Cutler Hammer, General Electric, Siemens, or Square D/Groupe Schneider.

F. EQUIPMENT CONNECTIONS

1. HVAC equipment
2. Plumbing equipment
3. Fire protection equipment
4. Elevators
5. Street Car Shop equipment:

QTY REQ	EQUIPMENT DESCRIPTION	HP	ELEC. LOAD/PHASE - AMPS				KW
			120/1	208/1	208/3	480/3	
5	Vehicle Jacks	7.5	0.0	0.0	24.2	0.0	43.6
1	Disk Belt Sander	1.50	0.0	11.0	0.0	0.0	2.3
1	Pedestal Grinder	2	0.0	13.2	0.0	0.0	2.7
1	Drill Press	-	12.0	0	0	0	1.4
1	3 ton jib crane	-	0.0	0.0	30.0	0.0	10.8
1	Small grinder buffer	-	12.0	0.0	0.0	0.0	1.4
1	Portable pressure washer	-	12.0	0.0	0.0	0.0	1.4
1	Air compressor	7.5	0.0	0.0	24.2	0.0	8.7
1	Air Dryer	1	0.0	8.8	0.0	0.0	1.8
1	Wire wheel grinder	1	16.0	0.0	0.0	0.0	1.9
1	Arc Welder	1	0.0	250.0	0.0	0.0	52.0
1	Drill Press	-	12.0	0	0	0	1.4
1	Lathe	15	0.0	0	20	0	7.2
1	Mean Steamer	-	12.0	0	0	0	1.4
1	Bead Blaster	1.5	0.0	0	6.6	0	2.4
1	Ice Melter rack	-	12.0	0	0	0	1.4
1	Shop Vac	-	12.0	0	0	0	1.4
1	Floor Polisher	-	0.0	12	0	0	2.5
1	Invertor	-	0.0	0	0	180	149.4
6	roll up doors	-	30.0	0	0	0	21.6

6. Owner furnished equipment
7. Motorized doors and gates
8. 120V power connections and empty conduit for security and access control system
9. Convenience and special purpose receptacles in building core and shell areas

10. Window washing equipment connections

G. RACEWAYS

1. All wire and cable shall be installed in conduit.
2. Rigid Steel Conduit: Rigid conduit, heavy wall, hot dipped galvanized inside and out, threaded ends with threaded type fittings. Use where exposed to physical damage, indoors where exposed to physical abuse and exposed outdoor installations.
3. Electrical Metallic Tubing: Continuous, seamless steel tubing, galvanized or sherardized on exterior, coated on interior with smooth hard finish of lacquer, varnish or enamel, with steel, set screw type fittings. Use for general purpose feeders and branch circuits.
4. Metal Clad (Type MC) Cable: Galvanized steel armor, copper conductors, insulated copper equipment grounding conductor, internal marker tape, screw in grounding type insulated throat type fitting with die cast steel locknut. Use in dry locations only concealed above suspended ceilings or within hollow partitions for lighting and receptacle branch circuits (not permitted for circuit home runs).
 - a. PVC jacketed MC Cable, rated for installation in concrete pour shall be used for both Feeder conductors from the Meter Stacks to the Load Center Panels and for the Branch circuits from the Load Centers to the outlets in the condominium units.
5. Flexible Steel Conduit: Single strip, continuous, flexible interlocked double-wrapped steel, hot dip galvanized inside and out forming smooth internal wiring channel, with steel, compression type fittings. Use in dry locations only, connections to lighting fixtures in suspended ceilings, connections to equipment installed above suspended ceilings, transformer connections, bus duct plug in units, and connections to equipment where vibration isolation is required, maximum length of 6-feet.
6. Liquid Tight Flexible Steel Conduit: Same as flexible steel conduit except with tough, inert, watertight plastic outer jacket. Fittings shall be cast malleable iron body and gland nut, cadmium plated with one-piece brass grounding bushings threaded to interior of conduit. Use same as flexible steel conduit in damp or wet locations and at motor connections.
7. Rigid Nonmetallic Conduit: Schedule 40 polyvinyl chloride with solvent cemented type fittings. Use in underground duct banks, below slab on grade, or embedded in floor slabs.

H. WIRE AND CABLE

1. 600V minimum insulation rating. Electrical grade, annealed copper, tinned if rubber insulated, THHN/THWN insulation. Stranded ASTM Class B. Minimum size number 12 for branch circuits; number 14 for control wiring.
2. Aluminum cable is allowed for feeders utilizing 1/0 AWG or larger for non-rotating and non-vibrating loads.

I. WIRING DEVICES

1. Switches and receptacles shall be specification grade. Receptacles shall be rated for 20 amps throughout the public areas. All switches shall be silent acting fully rated 20 amperes. Multiple pole, 3-way, 4-way, and special purpose type switches shall be provided as required. Special purpose receptacles shall be provided as required by the equipment characteristics. Device coverplates shall be Ivory or light color vinyl.
2. Public Spaces: Maximum of five per 20A, 120V circuit, located at lamp locations and for cleaning at 25-foot radius.
3. Condo Corridors: Maximum of five per 20A, 120V circuit, located every 50 feet along corridor walls.
4. Administration Areas: Maximum of five per 20A, 120V circuit, located at desks and work areas for electronic equipment, convenience and lamps.
5. Mechanical Areas: Maximum of five per 20A, 120V circuit, located within 25 feet of all mechanical equipment in mechanical rooms and on roofs.
6. Exterior of Building: Maximum of five per 20A, 120V circuit residual current circuit protected, located around building for landscape trimming, generally in vicinity of exit doors.

J. GROUNDING

1. Service Entrance.
 - a. Building service entrance grounding shall be achieved using Concrete encased electrode (Ufer ground) consisting of a minimum of 20 feet of bare copper conductor (size 4 minimum) encased by a minimum of 2 inches of concrete, located within and near the bottom of a concrete foundation or footing that is in direct contact with the earth.
2. Separately Derived Services.
 - a. All separately derived services will be grounded per NEC 250 as described in Section 16680.

K. STANDBY POWER SYSTEM

1. One radiator cooled, diesel fuel fired standby engine generator set rated 250kW, 480Y/277V, 3-phase, 4-wire, 60 Hz, 1800 rpm will be provided to supply power to emergency loads. Generator location can either be indoors in a dedicated space with a minimum 2-hour fire-rating or outdoors in an approved weatherproof, sound attenuated enclosure. A signal from any automatic transfer switch will start the engine and supply power to the emergency distribution system in the event of failure of the normal power source.
 - a. Generator will be exercised per the requirements of NFPA 110, 1996 edition. Permanently installed load banks will be installed to meet these requirements.
2. Emergency power distribution will be provided to serve the following equipment:
 - a. Exit signs
 - b. Egress lighting fixtures
 - c. Air handling system equipment where used for smoke control
 - d. Sump pumps and sewage ejector pumps
 - e. Minimum one service and one guest elevator serving all floors, transferable to any elevator
 - f. Fire management system
 - g. Telephone, Security, PMS, POS, Call Accounting, and UPS systems
 - h. Building management system and related air compressor
 - i. Electric fire pumps and jockey pump
 - j. Domestic water plant
3. Acceptable Manufacturers: Caterpillar or Cummins/Onan

L. FIRE MANAGEMENT SYSTEM

1. The fire management system will be the addressable type with each initiating device annunciated as an individual zone. The Fire Alarm and Control Panel (FACP) shall provide centralized control and annunciation of fire alarm zones. Area smoke detectors shall be analog type to permit monitoring and calibration of smoke detector sensitivity from the FACP.
2. The fire alarm system shall be fully supervised and include both manually and automatically actuated alarms consisting of:

- a. Manual pull stations – one in fire pump room, one in the building security room and at all stairs of R-2 occupancies.
 - b. Connections to fire sprinkler system water flow and tamper switches.
 - c. Area smoke detectors in each mechanical, electrical, telephone, and elevator machine room, at each stair and elevator lobby door fitted with magnetic hold open devices, in each elevator lobby for elevator recall, and in guest room corridors.
 - d. Duct type smoke detectors at the inlet of all return air duct stub outs, at main return air plenums, and at the discharge of each supply air fan.
 - e. Area smoke detectors (with local alarm) in sleeping areas of Residential Units- single station, 120V, hard wired, photoelectric type. These shall be stand alone and are not connected to the building fire management system.
3. The activation of any sprinkler flow switch, smoke detection device or manual pull station shall operate the voice communication system alarm system and initiate the smoke control sequence where appropriate. The fire alarm LED annunciator shall provide indication of the floor of an alarm and the type of alarm, i.e., manual, sprinkler flow, or smoke. The fire alarm system shall be connected to an approved central monitoring service. A Firefighter's Control and Indicating Panel (FCIP) shall be provided for manual override of the smoke control systems.
4. Firefighter's Telephone System (FTS) shall be provided to allow two-way communication between the Fire Control Center and plug in phone jacks. Plug in phone jacks shall be located in each elevator cab, the fire pump room and at each elevator lobby and stairwell location.
- Alternatively, the UBC allows for the FTS to be replaced with an in building RF distribution system (aka leaky coax or distributed antenna system) to support Fire Fighters hand held radio communications. The local fire department may have a preference for this type of communications systems. This type of system could be included in the building in replacement of the FTS.*
5. A Voice Communication System (VCS) shall provide evacuation signaling and selective paging to all areas of the building. Fire alarm speakers and visual alarm strobes shall be located all areas of the building.
6. A Fire Command Center will be located on the ground floor at a location approved by the Fire Department. Equipment located within the Fire Command Center shall include:
- a. Fire Alarm and Control Panel

- b. Annunciator Panel
 - c. Voice Communication System
 - d. Firefighter's Telephone System
 - e. Firefighter's Control and Indicating Panel
 - f. Generator Status Panel
 - g. Fire Pump Status Panels
 - h. Elevator Status and Control Panel and all required keys
 - i. Telephone for Outside Communication
 - j. Status indicators and controls for Smoke Control Systems.
 - k. Controls for unlocking all stairways simultaneously
7. Acceptable Manufacturers: Edwards System Technologies, Siemens and Simplex.

M. LIGHTING FIXTURES, LAMPS AND CONTROLS

1. This section covers lighting in equipment rooms, stairwells and other back of house spaces. Refer to the Lighting Consultant's report for description of public area and architectural lighting systems and specialty control systems.
2. Illumination will be in accordance with the recommendations of the Illuminating Engineering Society and Washington State Non residential energy code.
3. Lighting fixtures will be provided as follows (footcandle levels are average, maintained):
 - a. Equipment Rooms:
 - (1) Description: Surface or pendent mounted fluorescent with industrial style aperture reflector. Enclosed and gasketed type fixtures will be provided in equipment rooms that serve as air handling plenums.
 - (2) Illumination level: 30 footcandles.
 - b. Stairwells and Utility Corridors:
 - (1) Description: Surface wall mounted fluorescent with high impact acrylic lens.

- (2) Illumination level: 20 footcandles.
- c. Parking Areas:
 - (1) Description: Metal halide parking garage lighting fixture, low glare with uplight and downlight components.
 - (2) Illumination level: 5 footcandles in stalls, 10 footcandles in drive aisle, 40 footcandles at entry ramp.
- d. Street Car Shop:
 - (1) Description: High bay industrial fixtures.
 - (2) Illumination level: 30-50 footcandles.
- 4. Lighting systems shall utilize high efficiency, low glare fixtures. High power factor electronic ballasts will be provided where available.
- 5. Internally illuminated exit signs will be provided as required for safe egress and as required by code. Exit signs shall be edge-lit and high efficiency utilize LED sources. Self powered (nuclear) type exits signs will not be permitted. Low level exit signs will be provided at stairwell and main exit doors leading to egress from condominium unit corridors.
- 6. Lighting Controls in the Residential corridors will be continuously on with switching provided at the panelboard circuit breakers.
- 7. The Residential units have local 3-way and 4-way switching.
 - a. Each residential unit shall be furnished with a junction box, wiring and lighting switch to serve future dining area luminaire.
 - b. Each residential unit shall be furnished with (2) switches in each toilet room – one to control a fluorescent fixture and fan and the other to control a vanity luminaire.
- 8. The back-of-house areas will be locally switched through occupancy sensor control.
- 9. In the public areas, lighting control shall be provided by slide type wall dimmer boxes with emergency lighting transferred from dimmed or off to on through local contactors.

N. TELECOMMUNICATIONS INFRASTRUCTURE

- 1. Spaces.
 - a. A new Telecommunications point of demarcation MAY be required to serve the new residential tower. This room is typically 8'wx10'L minimum and will serve as the point of origin for the residential

phone and CATV services. At minimum, the room will require the following provisions:

- (1) Fire resistant terminal board on all four walls.
 - (2) A double duplex receptacle on each wall.
 - (3) Overhead wire management system.
 - (4) Grounding per NEC and TIA/ EIA 607.
- b. Telecommunications floor distributors will be required in the residential tower. These rooms shall be a minimum 6'Wx3'D and stacked. These rooms will require the following provisions:
- (1) Fire resistant terminal board on at least two walls.
 - (2) A double duplex receptacle on each wall.
 - (3) Overhead wire management system.
 - (4) Grounding per NEC and TIA/ EIA 607.

2. Pathways

- a. Four (4) 4" conduits will be provided from the nearest exterior Qwest and Comcast telecommunications vaults to the new point of demarcation.
- b. Four (4) 4" conduits will be provided from the new point of demarcation to the first telecommunications floor distributor.
- c. Four (4) 4" express conduits will be provided to connect the telecommunications floor distributors together vertically.
- d. Four (4) 2" conduits will be provided from the upper-most telecommunications floor distributor to the roof to serve potential DSL providers like Dish Network.
- e. Two (2) 1" conduits will be routed from the floor distributor to each residential unit served from that floor distributor.

3. Grounding.

- a. A main telecommunications-grounding bar (MTGB) will be provided at the point of demarcation. This grounding bar will be electrically connected to the main service entrance ground via a 4/0 conductor.
- b. A telecommunications-grounding bar (TGB) will be provided in each telecommunications floor distributor. Each grounding bar will

be connected to the grounding bar in the floor distributor below via a 1/0 conductor. The lowest TBG will be connected to the MTGB via a 1/0 conductor.

- c. All riser conduits serve telecommunications cabling will be bonded to together using a bare #6 ground conductor which will be tied back to the nearest TGB.

End of Section

200 Occidental Avenue, Seattle

LEED™ Checklist

Yes ? No

August 31, 2005

8/1/2005

Sustainable Sites 14 Point Worksheet Documentation Requirement

Prereq 1	Erosion & Sedimentation Control	Required	Seller
Credit 1	Site Selection	1	MKA/Mithun
Credit 2	Urban Redevelopment	1	Mithun
Credit 3	Brownfield Redevelopment	1	MKA/GeoTech
Credit 4.1	Alternative Transportation, Public Transportation Access	1	Mithun
Credit 4.2	Alternative Transportation, Bicycle Storage & Changing Rooms	1	Mithun
Credit 4.3	Alternative Transportation, Alternative Fuel Refueling Stations	1	Mithun/GBSRE
Credit 4.4	Alternative Transportation, Parking Capacity	1	Mithun/GBSRE
Credit 5.1	Reduced Site Disturbance, Protect or Restore Open Space	1	Landscape/MKA
Credit 6.2	Reduced Site Disturbance, Development Footprint	1	Mithun/GBSRE
Credit 6.1	Stormwater Management, Rate or Quantity	1	MKA/F+K/Landscape

5% of occupants . Put in Carpool spaces in public garage that are equivalent to 5% of the occupants. Put 5% of parking for trolley barn and retail be carpool.

Potentially, Add open space by 25% to achieve point/Green roof access?

Yes	?	No	Requirement
			(1) Use only captured rain or recycled site water for any additional 50% reduction (100% total reduction) of potable water for site irrigation needs. OR do not install permanent landscape irrigation systems.
			(2) Use high efficiency irrigation technology. OR, use captured rain or recycled site water to reduce potable water consumption for irrigation by 100% over conventional means.
			(3) Reduce the use of municipally provided potable water for building sewage conveyance by a minimum of 50%. OR, treat 100% of wastewater on site to tertiary standards.
			(4) Employ strategies that in equivalent use 20% less water than the water use baseline calculated for the building (not including irrigation) after meeting Energy Policy Act of 1992 failure performance requirement.
			(5) Exceed the potable water use reduction by at least 10% (15% total efficiency increase).

Water Efficiency	5 Points	Documentation
Credit 6.2	Stormwater Management, Treatment	MKA/Landscape
	1. What treatment is possible 2. Can we get point by utilizing CSO wastewater treatment?	
Credit 7.1	Landscape & Exterior Design to Reduce Heat Islands, Non-Roof	Mithun/Landscape
Credit 7.2	Landscape & Exterior Design to Reduce Heat Islands, Roof	Mithun
Credit 8	Light Pollution Reduction	F+K

Energy & Atmosphere	17 Points	Submittal	Documentation
Prereq 1	Fundamental Building Systems Commissioning	Required	F+K
Prereq 2	Minimum Energy Performance	Required	F+K
Prereq 3	CFC Reduction in HVAC&R Equipment	Required	F+K
Credit 1.1	Optimize Energy Performance: 12.5%	2	F+K

Credit	Requirement	Points	Documentation	Requirement
Credit 1.2	Optimize Energy Performance: 17.5%	1	F+K	
Credit 1.3	Optimize Energy Performance: 22.51%	1	F+K	
Credit 1.4	Optimize Energy Performance: 27.51%	1	F+K	
Credit 1.5	Optimize Energy Performance: 32.51%	1	F+K	
Credit 1.6	Optimize Energy Performance: 37.51%	1	F+K	
Credit 1.7	Optimize Energy Performance: 42.51%	1	F+K	
Credit 1.8	Optimize Energy Performance: 47.51%	1	F+K	
Credit 1.9	Optimize Energy Performance: 52.51%	1	F+K	
Credit 1.10	Optimize Energy Performance: 57.51%	1	F+K	
Credit 2.1	Renewable Energy, 5% Rooftop, facade and solar screens.	1	F+K/Milhun/Mike	Supply a net fraction of the building's total energy use (as expressed as a fraction of annual energy cost, through the use of on-site renewable energy systems based on the following total energy cost in renewables): 20% (1) In addition to the Fundamental Building Commissioning prerequisites, implement the following additional commissioning tasks: (1) Install base building level HVAC and refrigeration equipment and fire suppression systems that do not contain HCFC's or Halon. (1) Comply with the installed equipment requirements for continuous monitoring as stated in Option B; Methodology Technology of the US DOE's International Performance Measurement and Verification Protocol (IPMVP) for the following: (1) Engage in a two year contract to purchase power generated from renewable resources that meet the Center for Resource Solutions (CRS) Green-E requirements.
Credit 2.2	Renewable Energy, 10%	1	F+K/Milhun/MN	
Credit 2.3	Renewable Energy, 20%	1	F+K/Milhun/MN	
Credit 3	Additional Commissioning	1	F+K/Commis.Agent	
Credit 4	Ozone Depletion	1	F+K	
Credit 5	Measurement & Verification	1	F+K	
Credit 6	Green Power	1	F+K	

Materials & Resources	13 Points	Documentation	Requirement
Prereq 1	Storage & Collection of Recyclables	Milhun	
Credit 1.1	Building Reuse, Maintain 75% of Existing Shell	na	
Credit 1.2	Building Reuse, Maintain 100% of Shell	na	
Credit 1.3	Building Reuse, Maintain 100% Shell & 50% Non-Shell	na	
Credit 2.1	Construction Waste Management, Divert 50%	Sellen	
Credit 2.2	Construction Waste Management, Divert 75%	Sellen	
Credit 3.1	Resource Reuse, Specify 5%	Milhun/Sellen	
Credit 3.2	Resource Reuse, Specify 10%	Milhun/Sellen	
Credit 4.1	Recycled Content, Specify 10%	Sellen - Milhun	
Credit 4.2	Recycled Content, Specify 20%	Sellen - Milhun	

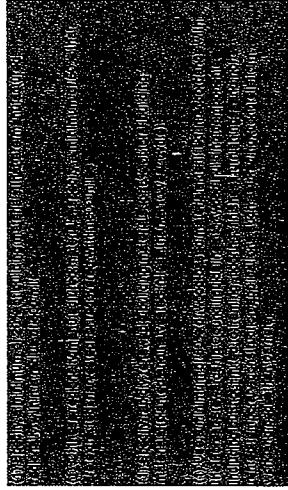

Credit 5.1	Local/Regional Materials, 20% Manufactured Locally	1	Sellen - Mithun
Credit 6.2	Local/Regional Materials, of 20% Above, 60% Harvested Locally	1	Sellen - Mithun
Credit 6	Rapidly Renewable Materials	1	Mithun-Sellen
Credit 7	Certified Wood	1	Mithun-Sellen

Yes ? No

Indoor Environmental Quality 15 Points

Prereq	Minimum IAQ Performance	Required	Documentation
Prereq 1	Minimum IAQ Performance	Required	F+K
Prereq 2	Environmental Tobacco Smoke (ETS) Control	Required	GBSRE
Credit 1	Carbon Dioxide (CO ₂) Monitoring	1	F+K
Credit 2	Increase Ventilation Effectiveness	1	F+K
Credit 3.1	Construction IAQ Management Plan, During Construction confirm use of MERV filters at Trolley Barn and retail areas	1	Sellen/F+K
Credit 3.2	Construction IAQ Management Plan, Before Occupancy confirm use of MERV filters at Trolley Barn and retail areas	1	Sellen/F+K
Credit 4.1	Low-Emitting Materials, Adhesives & Sealants	1	Mithun spec/Chris Dixon
Credit 4.2	Low-Emitting Materials, Paints	1	Mithun spec/Chris Dixon

Requirements

Meet the minimum requirements of voluntary consensus standard ASHRAE 62-1989, Ventilation for Acceptable Indoor Air Quality and approved Addenda

Zero exposure of non-smokers to ETS, achieved by: Prohibition of smoking in the building OR designated smoking room designed to contain, capture and remove ETS from the building

(1) Install a permanent carbon dioxide (CO₂) monitoring system that provides feedback on space ventilation performance in a form that affords operational adjustments. AND specify initial operational set point parameters that maintain indoor carbon dioxide levels no higher than outdoor levels by more than 600 parts per million at any time.

(1) For mechanically ventilated buildings, design ventilation systems that result in an air change effectiveness (E) greater than or equal to 0.9 as determined by ASHRAE 129-1997. For naturally ventilated spaces demonstrate a distribution and laminar flow pattern that involves not less than 80% of the room or zone area in the direction of air flow for at least 65% of hours of occupancy.

(1) During construction meet or exceed the minimum requirements of the Sheet Metal and Air Conditioning National Contractors Association (SMACNA) IAQ Guideline for Occupied Buildings under Construction, 1995, AND protect stored on-site or installed absorbent materials from moisture damage, AND replace all filtration media immediately prior to occupancy (Filtration media shall have a Minimum Efficiency Reporting Value (MERV) of 13 as determined by ASHRAE 62.2-1989).

(1) Conduct a minimum two-week building flushout with new filtration media at 100% outside air after construction ends and prior to occupancy. OR, conduct a baseline indoor air quality testing procedure consistent with current EPA protocol for Environmental Requirements, Baseline IAQ and Materials, for the Research Triangle Park Campus, Section 01446.

(1) Adhesives must meet or exceed the VOC limits of South Coast Air Quality Management District Rule #1168 by, AND all sealants used as a filler must meet or exceed Bay Area Air Resources Board Reg. 8, Rule 51

(1) Paints and coatings must meet or exceed the VOC and chemical component limits of Green Seal requirements.

Credit 4.3	Low-Emitting Materials, Carpet	1	Mithun spec/Chris Dixon	(1) Carpet systems must meet or exceed the Carpet and Rug Institute Green Label Indoor Air Quality Test Program.
Credit 4.4	Low-Emitting Materials, Composite Wood	1	Mithun spec/Chris Dixon	(1) Composite wood or agglomerate products must contain no added urea-formaldehyde resins.
Credit 5	Indoor Chemical & Pollutant Source Control	1	F+K	(1) Employ permanent entryway systems (grills, plates, etc.) to capture dirt, particulates, etc. from entering the building at all high volume entryways, AND provide areas with structural deck to deck partitions with separate outside air exhaust at a rate of at least .15 cfm per square foot.
Credit 6.1	Controllability of Systems, Perimeter	1	Mithun./Cross	(1) Provide a minimum of one operable window and one lighting control zone per 200 s.f. for all regularly occupied areas within 15 feet of the perimeter wall.
Credit 6.2	Controllability of Systems, Non-Perimeter	1	F+K	(1) Provide controls for each individual for airflow, temperature, and lighting for 80% of the non-perimeter, regularly occupied areas.
Credit 7.1	Thermal Comfort, Comply with ASHRAE 55-1992	1	F+K	(1) Comply with ASHRAE Standard 55-1992, Addenda 1995 for thermal comfort standards including humidity control within established ranges per climate zone.
Credit 7.2	Thermal Comfort, Permanent Monitoring System	1	F+K	(1) Install a permanent temperature and humidity monitoring system configured to provide operators control over thermal comfort performance and effectiveness of humidification and/or dehumidification systems in the building.
Credit 8.1	Daylight & Views, Daylight 75% of Spaces	1	F+K/ Mithun	(1) Achieve a minimum Daylight Factor of 2% (excluding all direct sunlight penetration) in 75% of all spaces occupied by critical visual tasks, not including copy rooms, storage areas, mechanical, laundry, and other low occupancy support areas. Exceptions include those spaces where tasks would be hindered by the use of daylight or where accomplishing the specific tasks within a space would be enhanced by the direct penetration of sunlight.
Credit 8.2	Daylight & Views, Views for 90% of Spaces	1	Mithun	(1) Direct line of sight to vision glazing from 90% of all regularly occupied spaces, not including copy rooms, storage areas, mechanical, laundry, and other low occupancy support areas.

Yes	?	No	Innovation & Design Process	5 Points	Documentation	Requirement(s)
			Credit 1.1 High % Waste recycling	1	Sellen	
			Credit 1.2 Innovation in Design:	1		
			Credit 1.3 Innovation in Design:	1		
			Credit 1.4 Innovation in Design:	1		
			Credit 2 LEED™ Accredited Professional	1	Mithun	

Project Totals 69 Points

Certified 26-32 points
Silver 33-38 points
Gold 39-51 points
Platinum 52-69 points

Yes	?	No	Category Breakdown	% of Catg. % of total
8	5	1	Sustainable Sites	57% 21%
4	1	1	Water Efficiency	80% 10%
9	7	1	Energy & Atmosphere	53% 23%
4	3	6	Materials and Resources	31% 10%
12	3	3	Indoor Environmental Quality	80% 31%
2	1	2	Innovation and Design Process	40% 5%
39	20	6		57% 100%

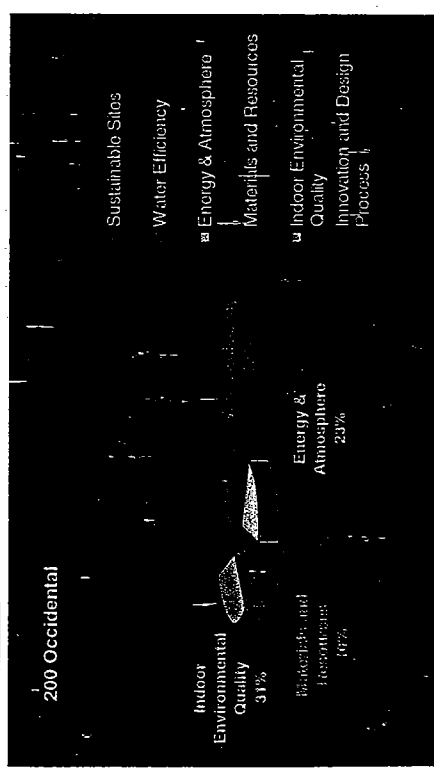

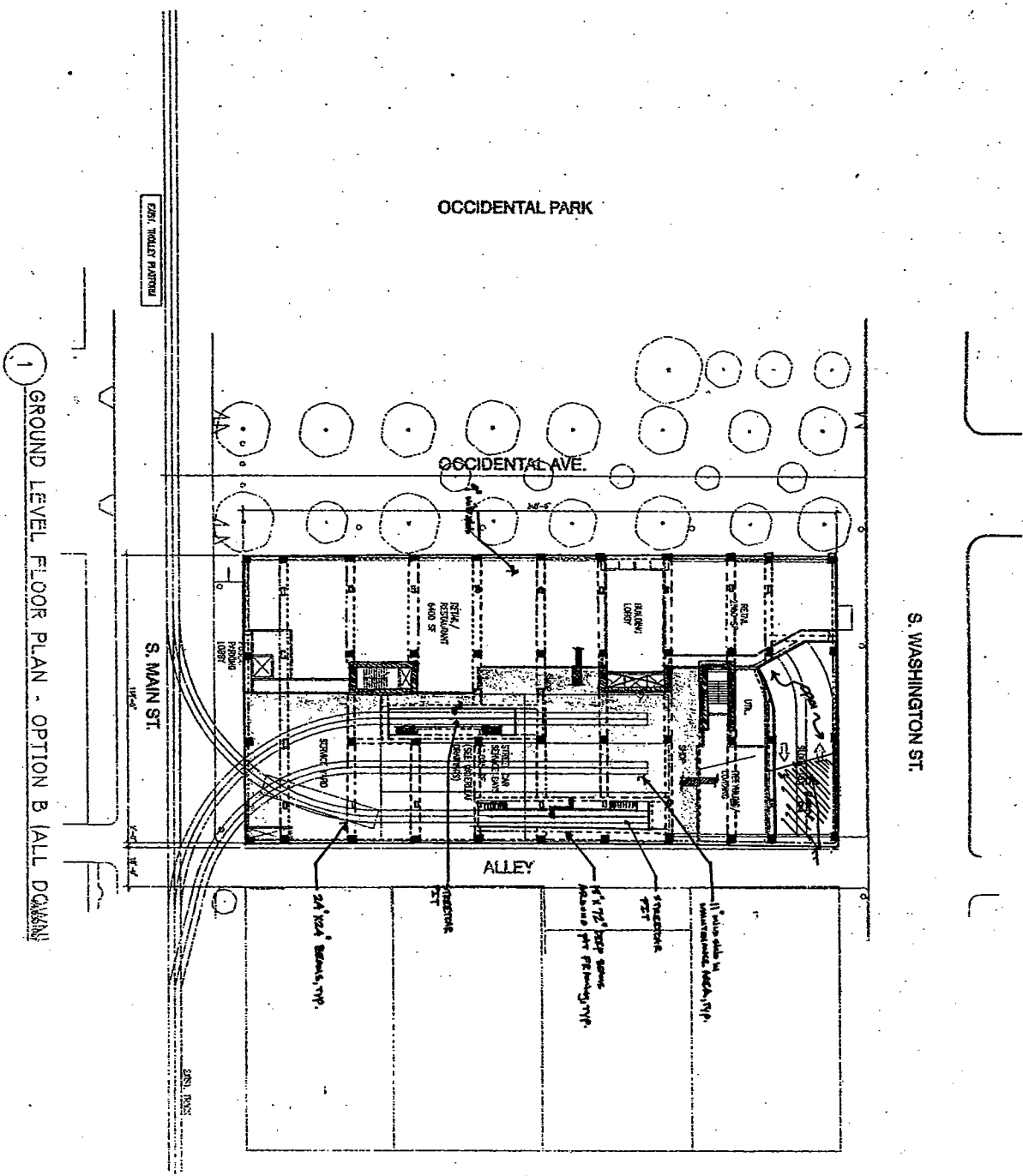

1 GROUND LEVEL FLOOR PLAN - OPTION B (ALL DOWN)

200 OCCIDENTAL
 GREGORY BRODERICK SMITH REAL ESTATE
 810 Tenth Avenue, Suite 60
 Norfolk, VA 23510-1620
 Metro 252.282.2280
 Fax 252.282.2289



MITHUN
 Architects/Designers/Planners
 1000 North 19th Street
 Suite 100
 Norfolk, VA 23510
 Tel: 252.653.3444
 Fax: 252.653.7005

PROGRESS
 PRINT 8-16-06
 S-5
 0.511P 27 47
 5-16-06
 8-16-06

1 TYP. HOUSING FLOOR PLAN - ATRIUM OPTION 1/2000 CSF, 19 UNITS

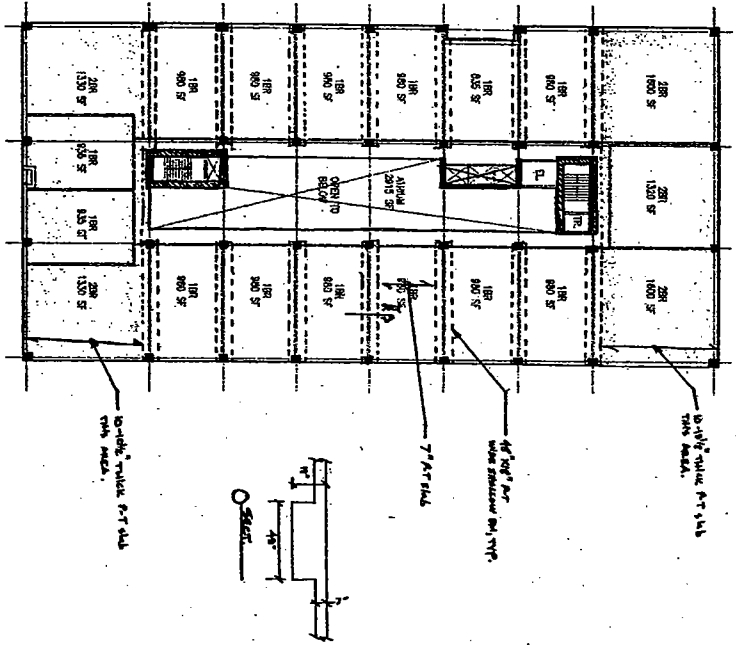

2 TYP. HOUSING FLOOR PLAN - TERRACE OPTION 1/2000 CSF, 19 UNITS

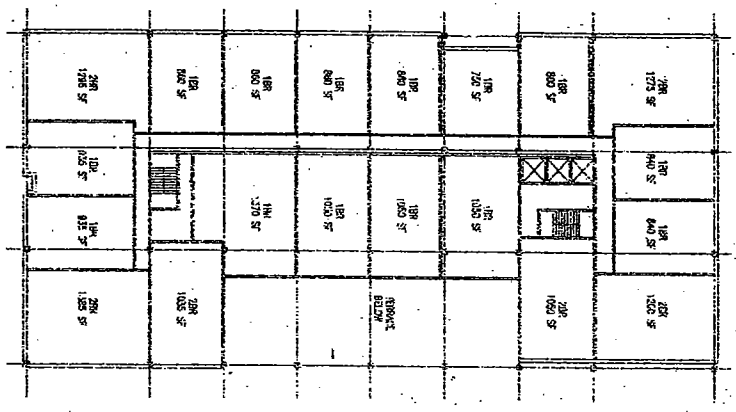

PROGRESS
PRINT 4-18-08
S-3



200 OCCIDENTAL
GREGORY BRODERICK SMITH REAL ESTATE
810 Two Arms, Suite 60
Sarasota, FL 34234-1520
Tel: 941.555.9999
Fax: 941.555.9999

Plot 15
1501 Parkside Way
Sarasota, VA 34234
Tel: 941.555.9999
Fax: 941.555.9999

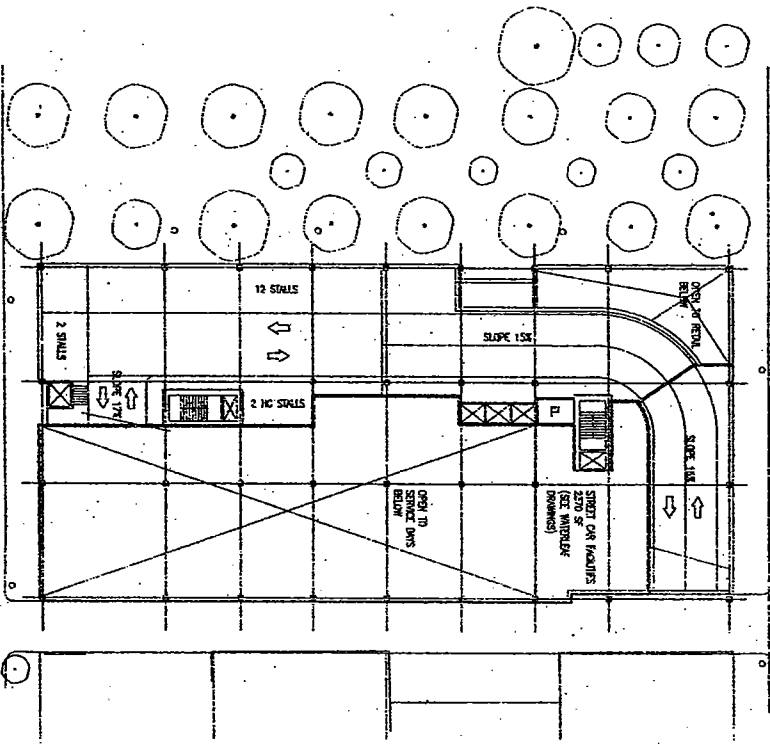

1 LEVEL 2 FLOOR PLAN - OPTION A

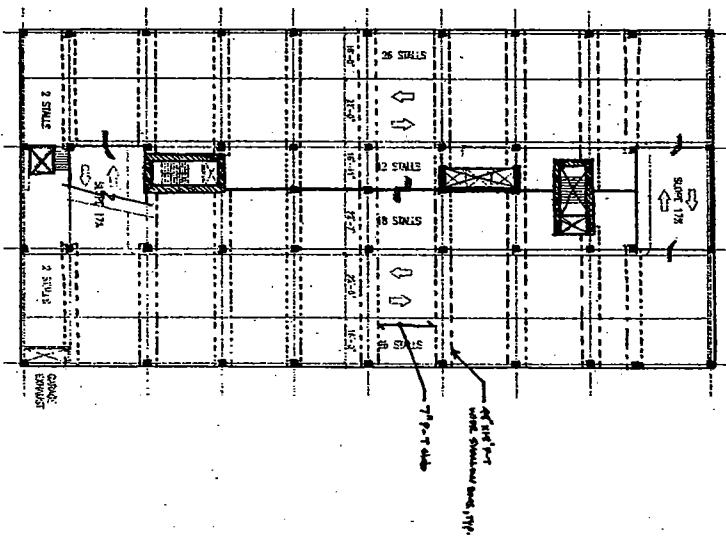

2 TYP. PARKING FLOOR PLAN - OPTION A (CALL-UP SQUARE)

MITHUN
Architects-Designers-Planners

Per 16
Tom Ashkanan
Sally Ann
Seymour, WA 98101
Tel: 206.453.1344
Fax: 206.453.7003

200 OCCIDENTAL
GREGORY BRODERICK SMITH REAL ESTATE
810 Tenth Avenue, Suite 612
Seattle, WA 98104-1620
Mar 206.262.2886
Fm 206.262.2886

King County METRO

PROGRESS
PRINT RELEASE
S-2
0 8 10 20 40 60
\$-31-04

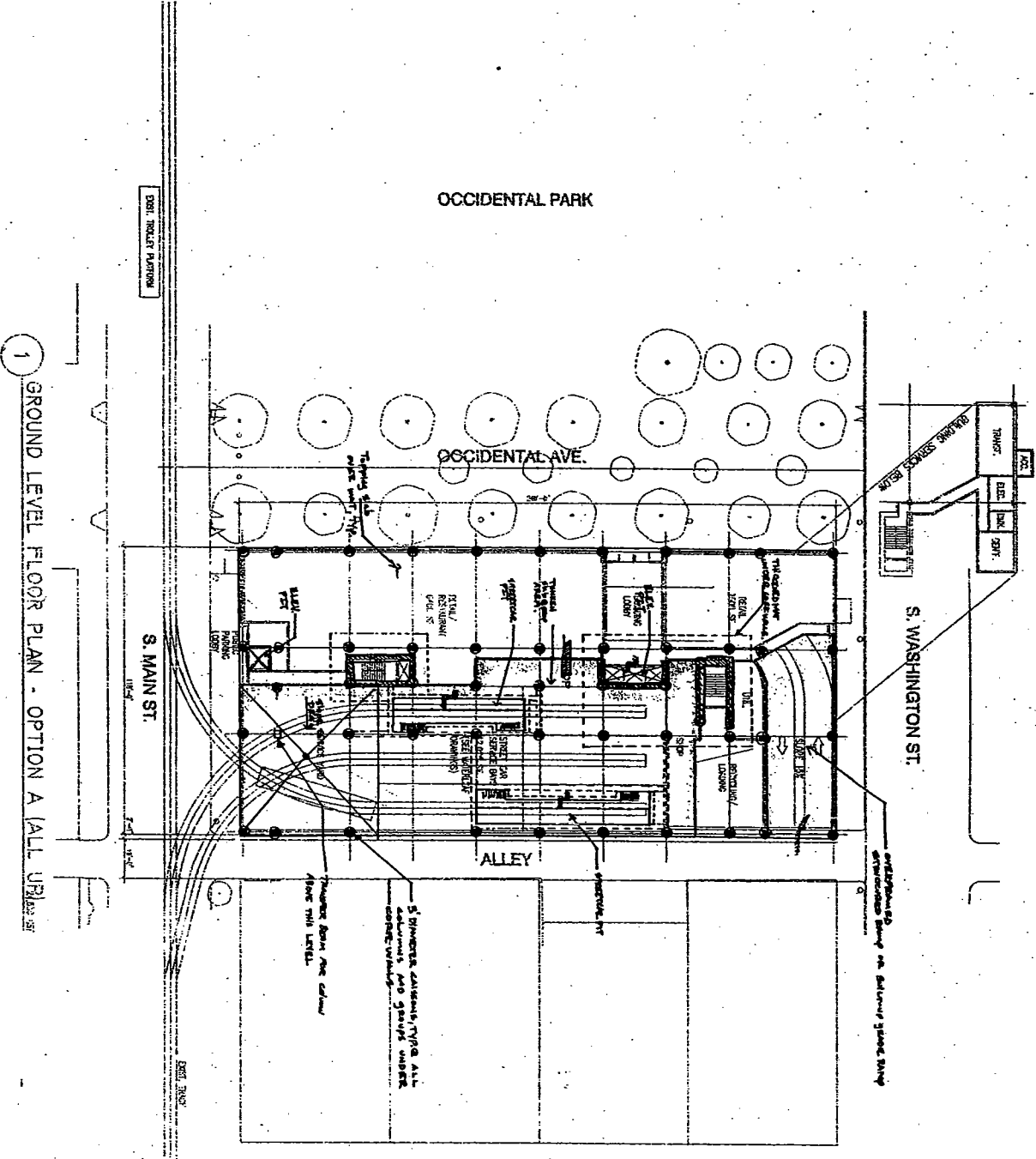

1 GROUND LEVEL FLOOR PLAN - OPTION A (ALL UP)

OCCIDENTAL PARK

OCCIDENTAL AVE.

S. WASHINGTON ST.

S. MAIN ST.

ALLEY

S. WASHINGTON ADJACENT PLOTS, TYPE ALL EXISTING AND STAY IN CONTACT WITH THIS LEVEL.

S. WASHINGTON ST. STRUCTURED PARKING ON ADJACENT PLOT BEING

PROGRESS
PRINT 8-1-06
S-1



200 OCCIDENTAL

GREGORY BRODERICK SMITH REAL ESTATE



819 Third Avenue, Suite 200
Seattle, WA 98104-1628
Mob: 206.282.2880
Fax: 206.282.2889

Part 16
John Ashbaugh/VP
Sara Lee
Seattle, WA 98101
Tel: 206.693.3444
Fax: 206.693.7005

MITHUN
Architects-Designers-Planners

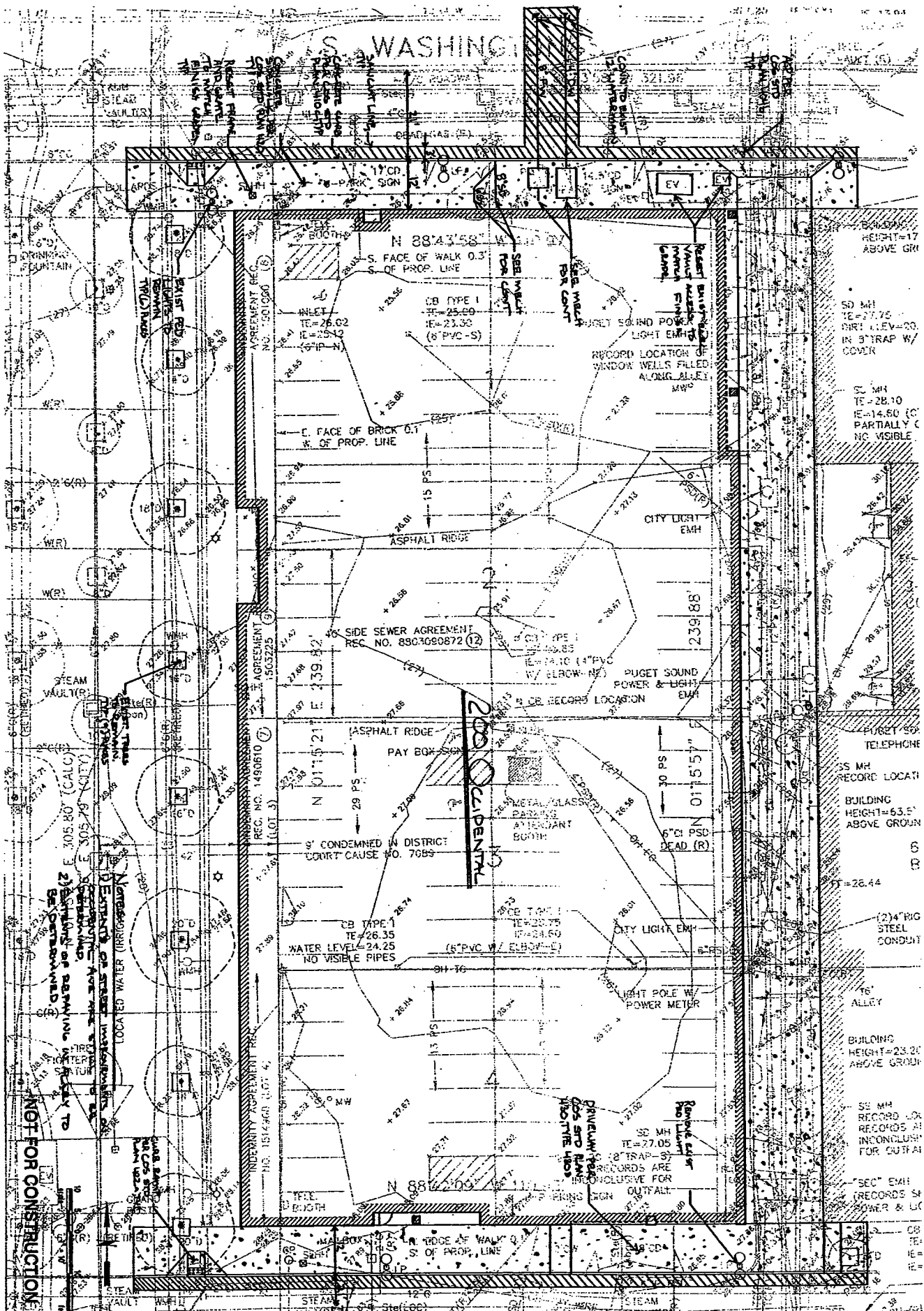

NOT FOR CONSTRUCTION

400

PROCEEDING CERT
4000 01/14/00

Civil Site Plan

DATE: 01/14/00
BY: MATHIAS
CHECKED BY: MATHIAS
APPROVED BY: MATHIAS

200 OCCIDENTAL

GREGORY BRODERICK SMITH REAL ESTATE

1000 1st Ave, Seattle, WA 98101
206 467-1111

MITHUN

Engineering & Surveying
1000 1st Ave, Seattle, WA 98101
206 467-1111

Level M Plan

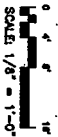

NOT FOR CONSTRUCTION

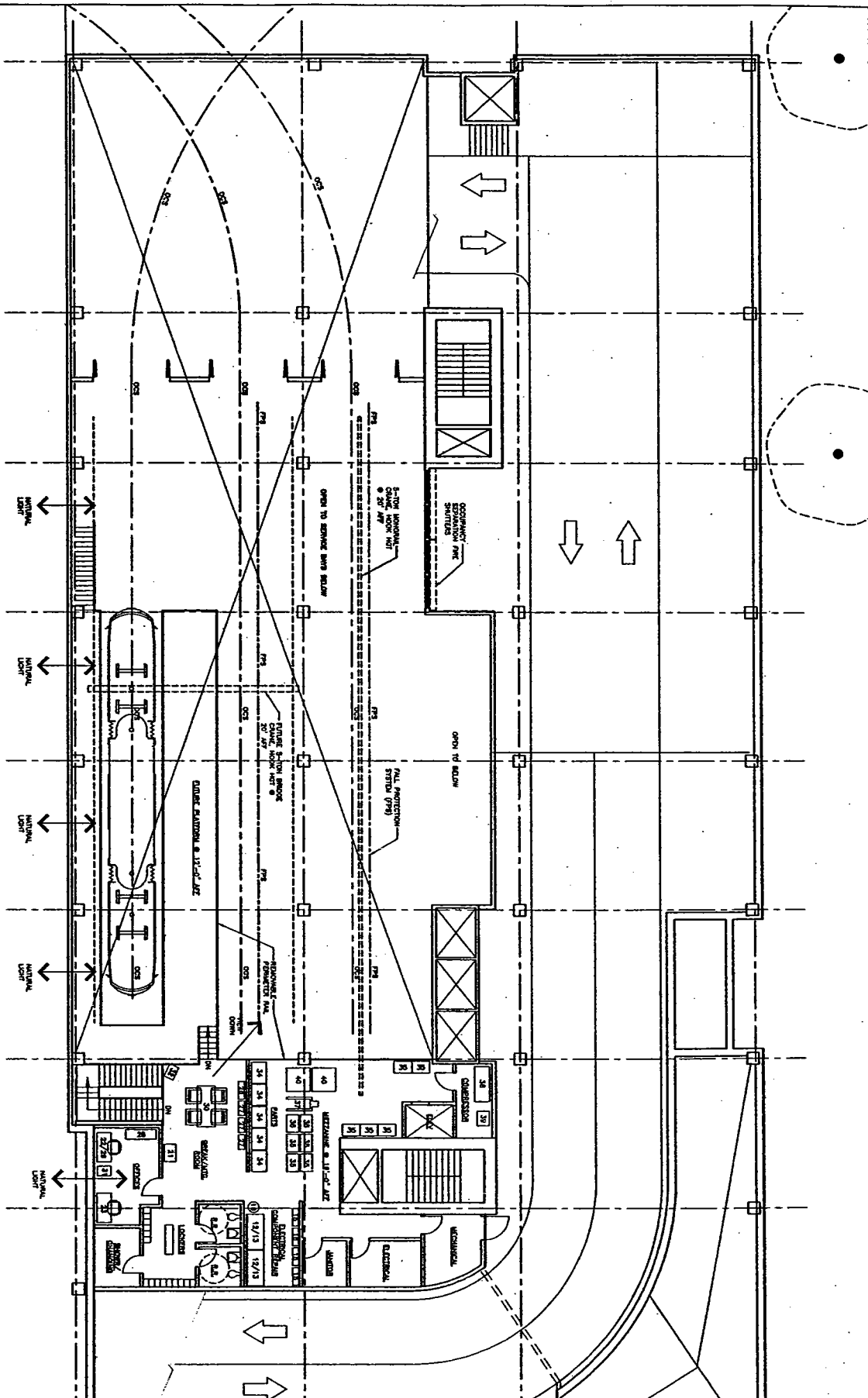

King County Metro
Level M Plan
08117
30 AUGUST 2008
PUNCH LIST
© 2008 MITHUN, INC.

200 OCCIDENTAL
GREGORY BRODERICK SMITH REAL ESTATE



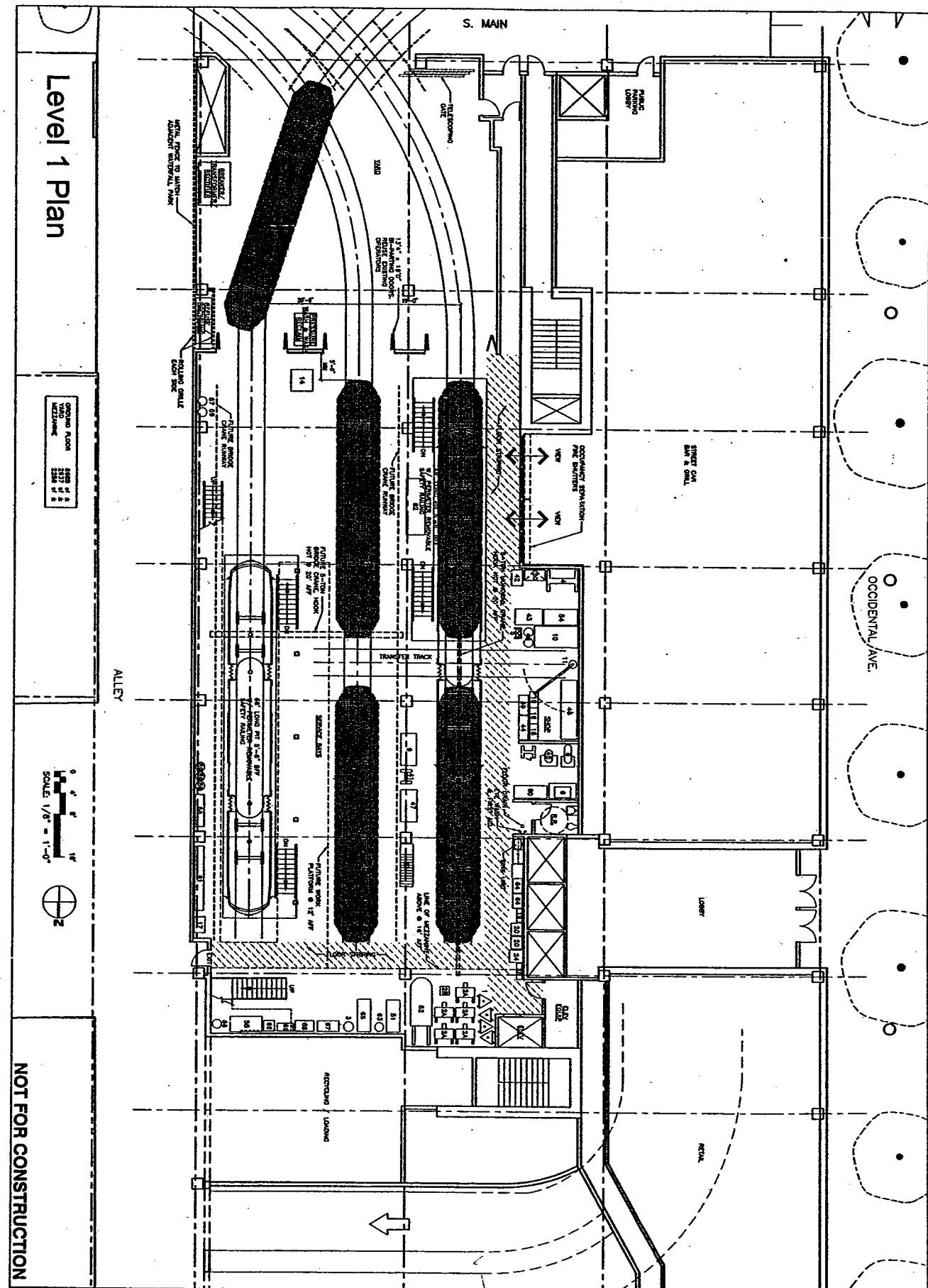

Level 1 Plan

GROUND FLOOR
AREA 11,117 sq. ft.
VOLUME 11,117 cu. ft.
SCALE 1/8" = 1'-0"

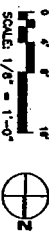

NOT FOR CONSTRUCTION

200 OCCIDENTAL

GREGORY BRODERICK SMITH REAL ESTATE

MITHÜN

waterleaf

PENDING SET
© 2004 MITHÜN, INC.

King County Metro
Level 1 Plan
05/17
30 AUGUST 2004

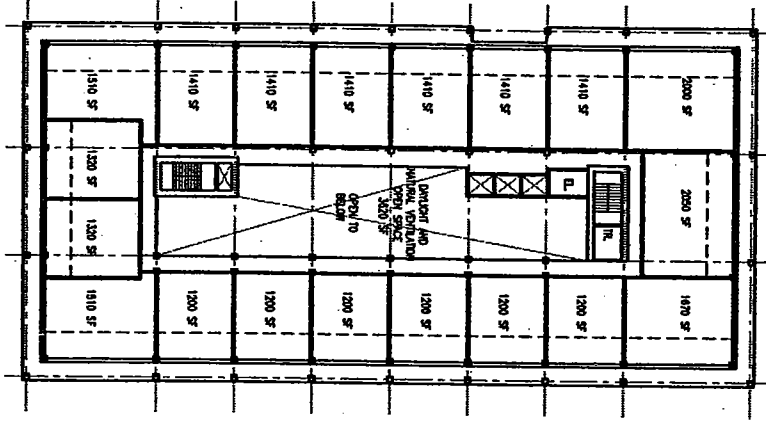

1 PENTHOUSE LEVEL PLAN - NATURAL VENTILATION OPTION

APPROX. 26,344.12 SQ. FT. 19 UNITS
1" = 3/8"

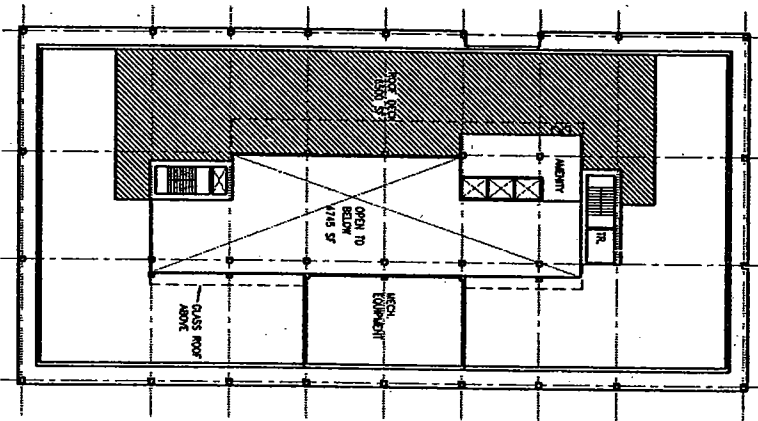

2 ROOF PLAN - NATURAL VENTILATION OPTION

1" = 3/8"

NOT FOR CONSTRUCTION

MITHUN

200 OCCIDENTAL

GREGORY BRODERICK SMITH REAL ESTATE

RESIDENTIAL
PENTHOUSE PLAN
AND ROOF PLAN
08/17
30 AUGUST 2005
S.A. SERRAVALLO/CLAD
ABRETT/M.A.B.
A/B.6
PHONING SET
© 2004 MITHUN, INC.

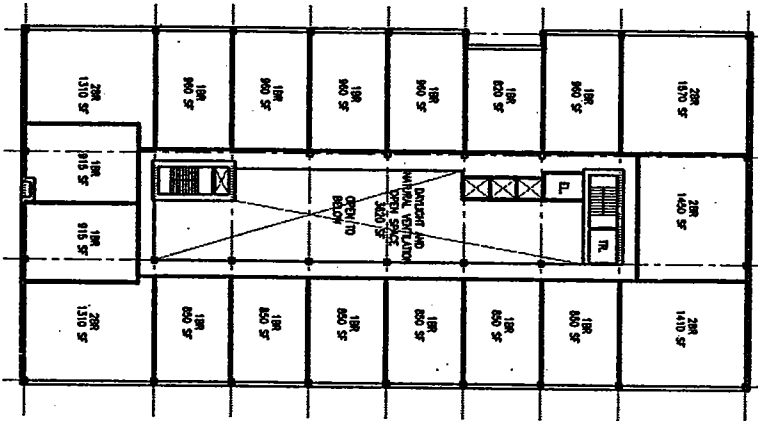

1 TYP. HOUSING FLOOR PLAN - NATURAL VENTILATION OPTION APPROX. 24,575 GSF, 19 UNITS 1" = 3/8"

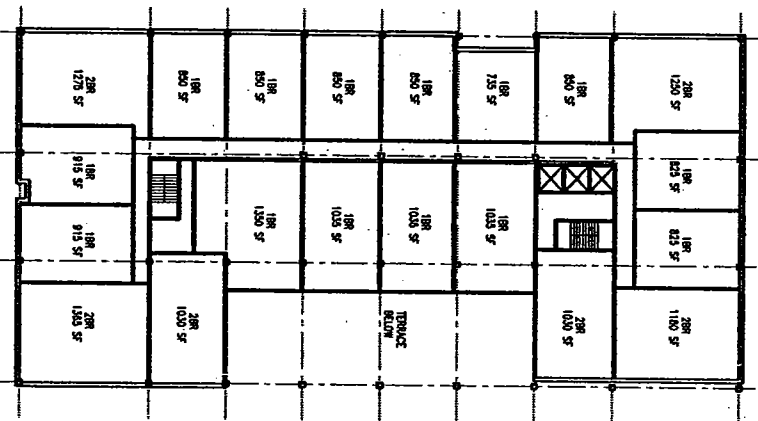

2 TYP. HOUSING FLOOR PLAN - CORRIDOR OPTION APPROX. 24,735 GSF, 20 UNITS 1" = 3/8"

NOT FOR CONSTRUCTION

MITHUN
 REAL ESTATE
 10000 W. 10TH AVE.
 SUITE 1000
 DENVER, CO 80202

200 OCCIDENTAL
 GREGORY BRODERICK SMITH REAL ESTATE
 1000 W. 10TH AVE.
 SUITE 1000
 DENVER, CO 80202

ATRILUM & TERRACE
 OPTIONS HOUSING
 FLOOR PLANS
 08/17
 20 AUGUST 2008
 S.L. 3000003170004000
 ARNETT/SMITH
A/B.5
 PUNCHING SET
 © 2008 MITHUN, INC.

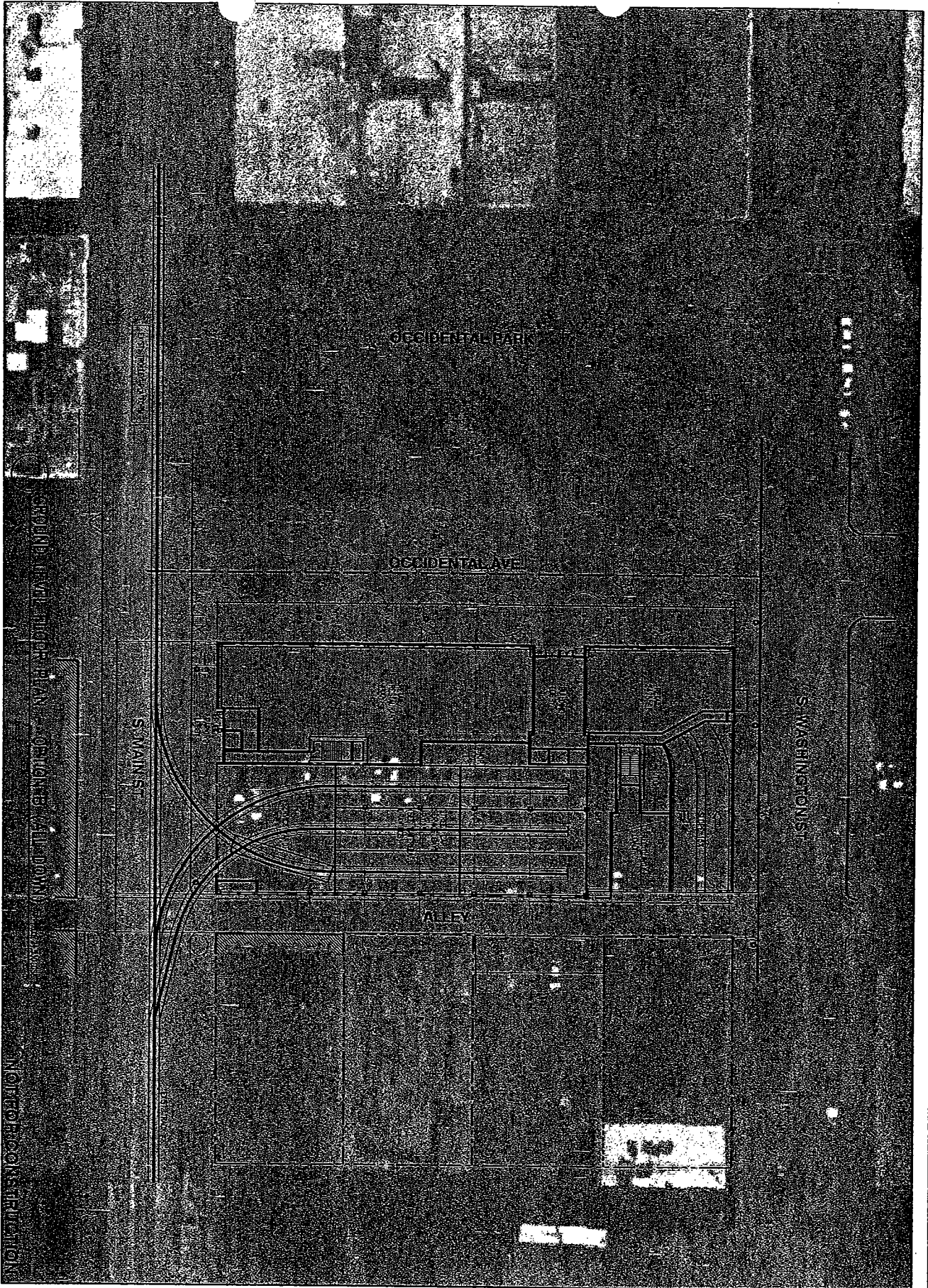

OCCIDENTAL PARK

OCCIDENTAL AVE

S WASHINGTON ST

VALLEY

GROUND LEVEL FLOOR PLAN - OPTION B - ALL DOWN

S MAIN ST

NOT TO BE CONSIDERED A FINAL PLAN

MITHUN
 ARCHITECTS
 1000 North 17th Street
 Suite 200
 Phoenix, AZ 85016
 Tel: 602.944.2000
 Fax: 602.944.2001

200 OCCIDENTAL
 GREGORY BRODERICK SMITH REAL ESTATE
 425 First Avenue, Suite 200
 Phoenix, AZ 85004-1000
 Tel: 602.252.2000
 Fax: 602.252.2001

GROUND LEVEL
 FLOOR PLAN
 OPTION B
 05/17
 29 AUGUST 2008
 81.2000(08)1707(C)ADON
 ALBERT819.3

B.3
 PENDING SET
 © 2008 MITHUN, INC.

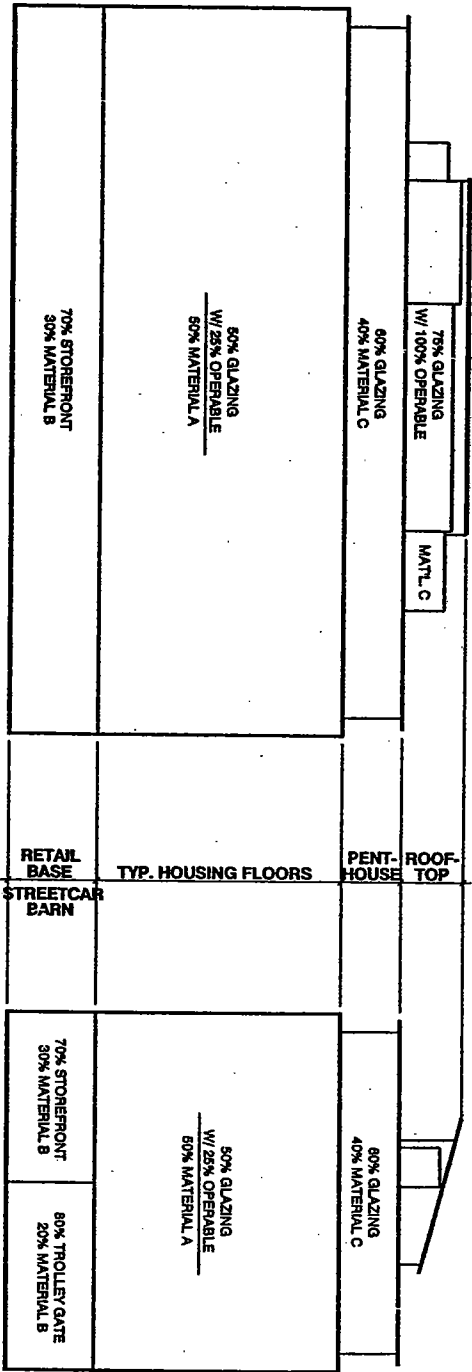

1 EXTER. MATERIALS DIAGRAM OPTION B - OCCIDENTAL

2 EXTER. MATERIALS DIAGRAM - S. MAIN

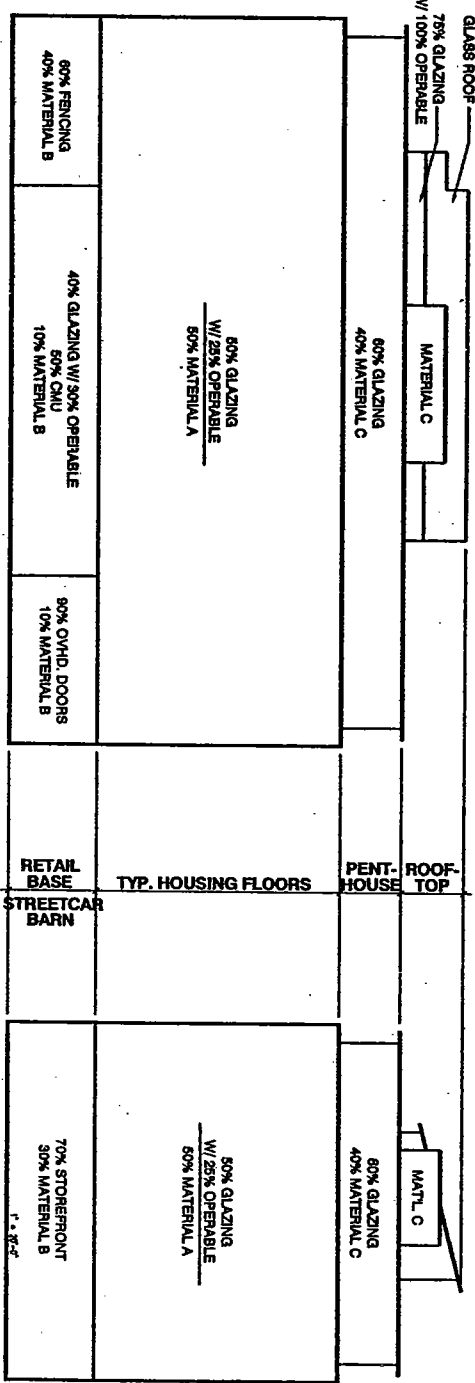

3 EXTER. MATERIALS DIAGRAM OPTION B - ALLEY

4 EXTER. MATERIALS DIAGRAM - S. WASHINGTON

NOT FOR CONSTRUCTION

MITHUN
A REAL ESTATE COMPANY

For Further Info
Call 202.775.8000
or visit our website
www.mithun.com

200 OCCIDENTAL
GREGORY BRODERICK SMITH REAL ESTATE

EXTERIOR MATERIAL
DIAGRAMS
OPTION B
08/17
30 AUGUST 2008
61.200058170000000
ALBERTO B
B.2
PRICING SET
© 2008 MITHUN, INC.

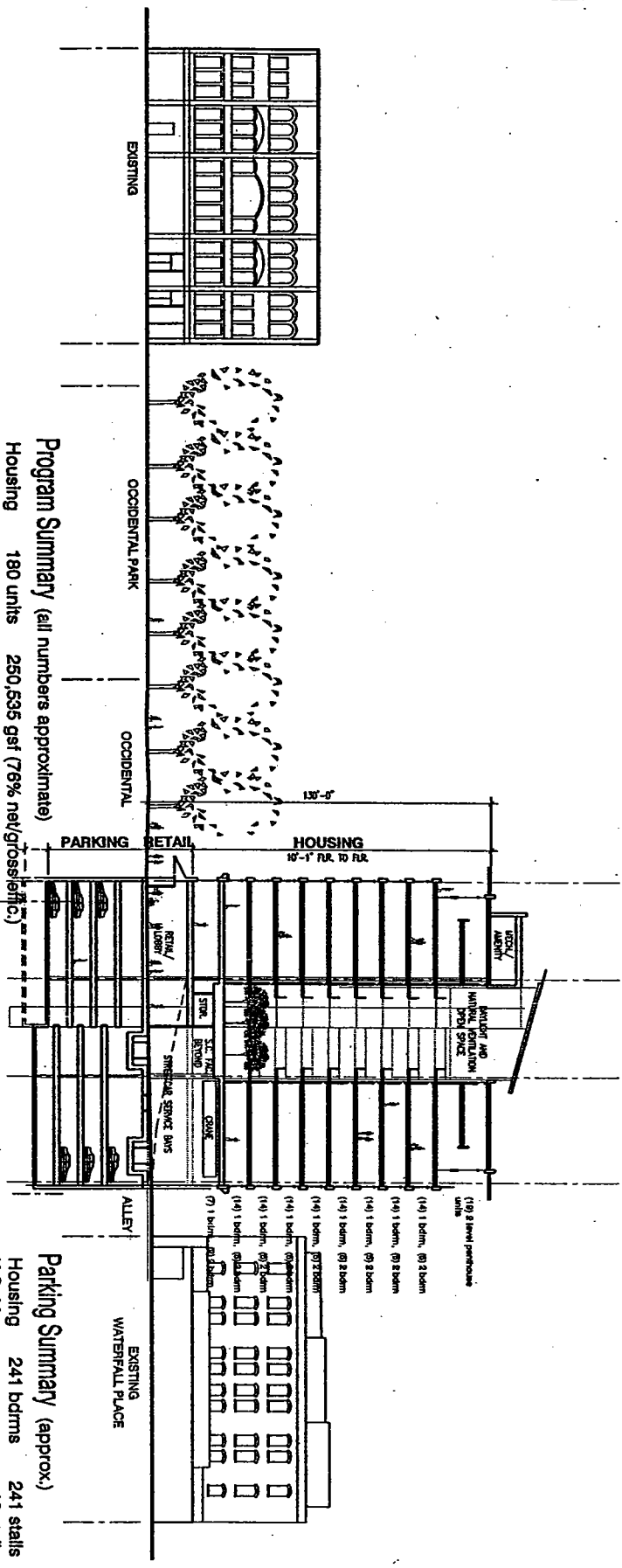

Program Summary (all numbers approximate)
 Housing 180 units 250,535 gsf (76% net/gross/eff.c.)
 Street Car Facilities 14,400 gsf
 Retail 8,825 nsst
 Parking 359 stalls 122,890 gsf (342 sf/stall)

Parking Summary (approx.)
 Housing 241 bdrms 241 stalls
 K.C. Metro 18 stalls
 Retail (short term) 100 stalls
 total 359 stalls

1 TRANSVERSE BUILDING SECTION - OPTION B

NOT FOR CONSTRUCTION

TRANSVERSE BUILDING SECTION
 OPTION B
 08/17
 30 AUGUST 2008
 61.2000060317000000
 AHS/ETD/1
B.1
 PUNCH SET
 © 2008 MITHUN, INC.

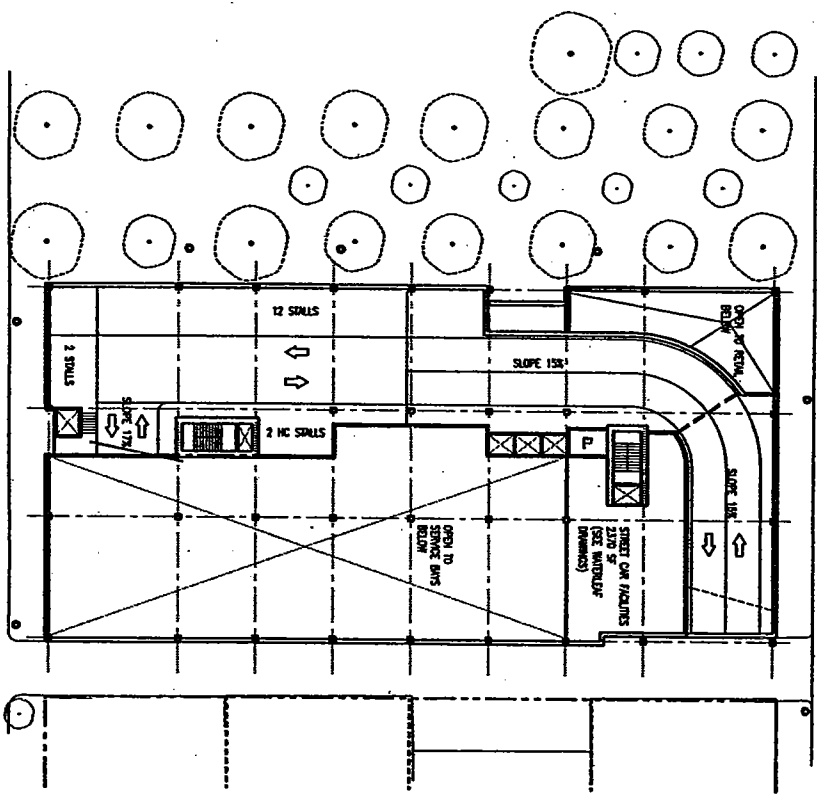

1 LEVEL 2 FLOOR PLAN - OPTION A

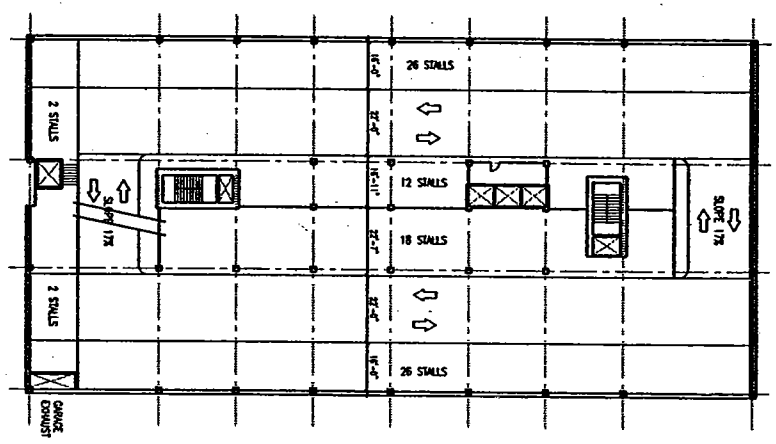

2 TYP. PARKING FLOOR PLAN - OPTION A

APPROX. 24.27% GRD. OR STALLS
1" = 3'-0"

NOT FOR CONSTRUCTION

MITHUN
ARCHITECTS

For Further Information
Contact the Architect
at the address below

200 OCCIDENTAL
GREGORY BRODERICK SMITH REAL ESTATE

LEVEL 2 AND TYP.
PARKING PLANS
OPTION A

A.4

PARKING SET
© 2001 MITHUN, INC.

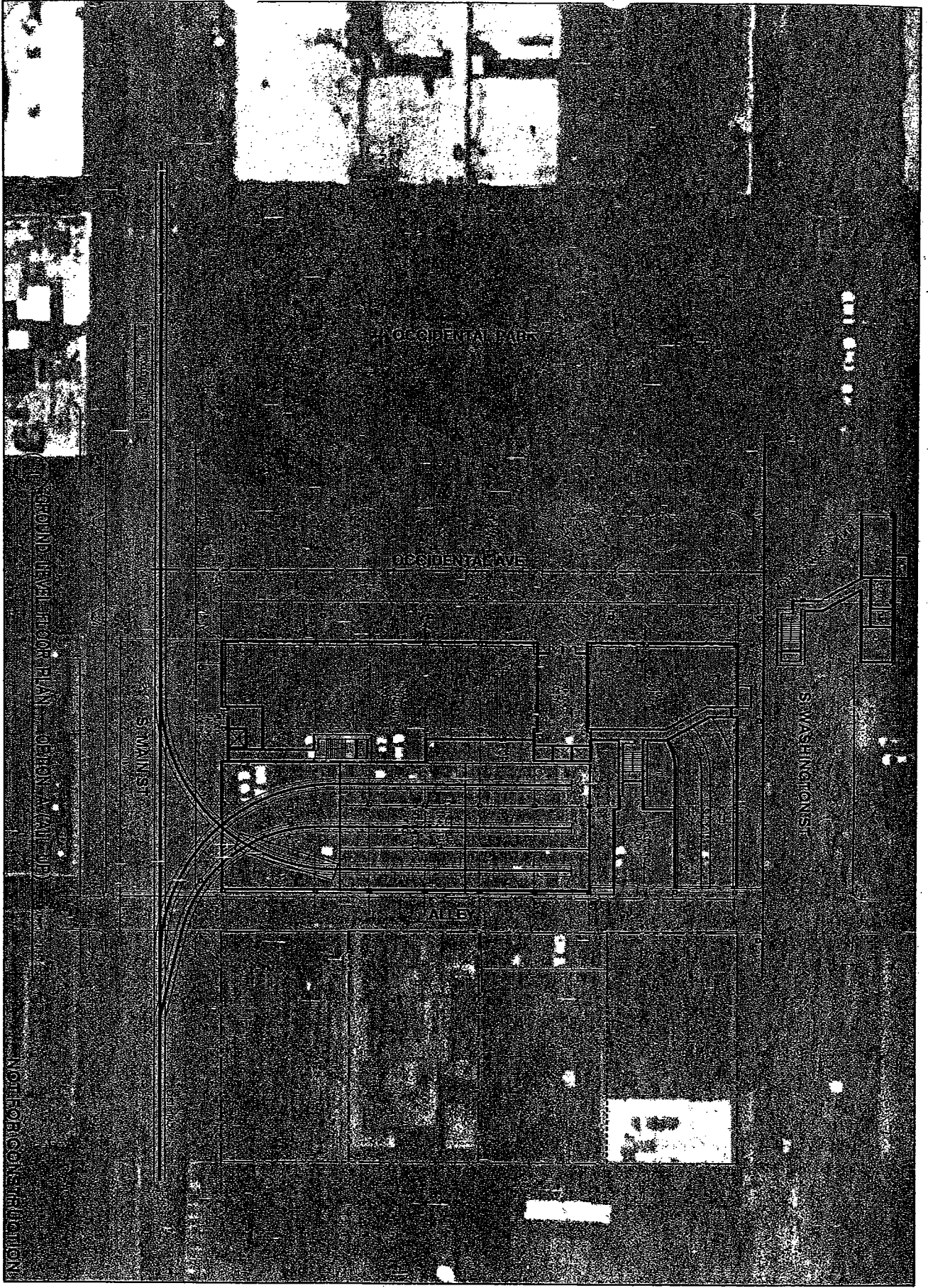

GROUND LEVEL FLOOR PLAN OPTION A (A1B)

S WAINSTON ST

OCCIDENTAL AVE

OCCIDENTAL AVE

S WASHINGTON ST

A1B

NOT FOR CONSTRUCTION

GROUND LEVEL
FLOOR PLAN
OPTION A
 DATE: 08/17/20
 PREPARED BY: JG
 PROJECT NO: 81120003517000000
 SHEET NO: 08/17/20
 DATE: 30 AUGUST 2020
 PROJECT: 81120003517000000
A.3
 SHEET NO: 3
 PROJECT SET
 © 2020 MITHUN, INC.

200 OCCIDENTAL

GREGORY BRODERICK SMITH REAL ESTATE

1000 W. 10th St.
 Suite 100
 Oklahoma City, OK 73101
 Phone: (405) 598-1000
 Fax: (405) 598-1001
 Email: gbsmith@grbsmith.com

MITHUN
 Architecture | Design | Interiors
 1000 W. 10th St.
 Suite 100
 Oklahoma City, OK 73101
 Phone: (405) 598-1000
 Fax: (405) 598-1001
 Email: mithun@mithun.com